



HIGH VOLTAGE SERIES LI-ION RACK MOUNT SYSTEM



INSTALLER MANUAL

HIGH VOLTAGE BATTERY

Global Tech China Ltd, Units 702-704, 7/F Texwood Plaza,
6 How Ming Street, Kwun Tong, Kowloon, Hong Kong.
Tel: +852 2884 4318 Fax: +8522884 4816

www.sunsynk.com / sales@sunsynk.com

v.16 (06/27/23)



**PLEASE RETAIN FOR
FUTURE REFERENCE**

Table of Contents

1. IMPORTANT INFORMATION IN THE MANUAL	5
1.1. Scope	5
1.2. HV-Series Set	5
1.3. Meaning of Symbols	5
1.3.1. Symbols on Equipment	6
1.4. General Safety Information	7
1.5. Disclaimer	7
1.6. Proper Use	7
1.7. Quality Certificate	8
1.8. Requirements for Installation Personnel	8
2. SAFETY	9
2.1. Safety Rules	9
2.2. Safety Information	9
3. TRANSPORT TO THE END CUSTOMERS	10
3.1. Provisions on Shipping of Battery Modules	10
3.2. Permissible and Impermissible Storage Positions of a Packaged	11
3.2.1. Battery Module	11
4. PREPARATION	12
4.1. Tools Required	12
4.2. Auxiliary Tools and Materials Required	12
5. DESCRIPTION AND INSTALLATION	13
5.1. Installation Precautions	13
5.2. Product Description	13
5.3. Technical Data	13
5.4. Description of Rack	14
5.5. Installation of Rack	16
5.6. Description of Battery Module	19
5.7. Description of High-Voltage Control Box	19
5.8. Description of Battery Module in Rack	20
5.9. Installation of the Battery Module to the Rack	22
5.10. Startup Steps of High Voltage Series Battery	22
5.11. External 12V Power Supply of High-Voltage Control Box	23

6. DISPLAY	23
6.1. Home Screen	23
6.1.1. Basic Parameters	23
6.1.2. Fault Indication	24
6.2. System Maintenance	24
6.2.1. Main Screen	25
6.2.2. System Maintenance Menu	25
6.2.2.1. System information	25
6.2.2.2. Volt/Temp information	26
6.2.2.3. Relay status	26
6.2.2.4. Version information	26
6.2.3. Fault Pages	27
6.2.3.1. Under Voltage (UV)	27
6.2.3.2. Over Voltage (OV)	27
6.2.3.3. Under Temperature (UT)	28
6.2.3.4. Over Temperature (OT)	28
6.2.3.5. Over Current (OC)	28
6.2.3.6. Different Voltage (DV)	29
6.2.3.7. Different Temperature (DT)	29
6.2.3.8. Other Faults (OF)	29
6.2.4. Maintenance Interface	30
7. INSTRUCTIONS FOR HVESS-MONITOR USE	31
7.1. Main Page	31
7.2. Function List	31
7.3. Function Description	32
7.3.1. CAN Communication Configuration	32
7.3.2. Basic Information	32
7.3.3. Parallel Information	34
7.3.4. History Data	34
7.3.5. History Records	35
7.3.6. History Events	36
7.3.7. Real-Time Data Storage of the HVESS-Monitor	37
7.3.8. Parameter	38
7.3.9. INTER-CAN Firmware Upgrade	39
7.3.10. Manufacture	39
7.3.11. Cell Types	40
7.3.12. Inverter Information	41
7.3.13. PCS CAN Firmware Upgrade	42
8. FAULT DESCRIPTION	43

9. FAULT TYPES SUMMARY IN SCREEN AND HVESS-MONITOR	45
10. MAINTENANCE AND UPGRADE	47
10.1. Maintenance of High Voltage Series Battery	47
10.2. USB's Upgrade Step	48
11. BATTERY MODULE STORAGE	48
12. DISPOSAL	49
APPENDIX	50
Circuit Diagram for On Grid System with 12V Supply	50

1. IMPORTANT INFORMATION IN THE MANUAL

1.1. Scope



The installation and operation manual applies to the modular battery energy storage system. Please carefully read this installation and operation manual to ensure the safe installation, preliminary debugging, and maintenance of the High Voltage Series. Installation, preliminary debugging, and maintenance must be carried out by qualified and authorized personnel. Please keep this installation and operation manual and other applicable documents near the battery energy storage system, so that all personnel involved in installation or maintenance can access this installation and operation manual at any time.

This installation and operation manual only applies to countries meeting the certification requirements. Please observe the applicable local laws, regulations, and standards. Standards and legal provisions of other countries may be inconsistent with the provisions and specifications. In this manual. In this case, please contact our after-sales service personnel, Tel: +852 2884 4318 Fax: +8522884 4816/ Email: www.sunsynk.com / sales@sunsynk.com

1.2. HV-Series Set







High Voltage Series Battery Set	
System energy	61.44 kWh (12 x 5.12kWh HV Battery)
Composition	HVB750V/100A*1 [HV-SeriesM5.1*12]
BMS	1
13-way battery rack	1
Connectors and cabling	Included

1.3. Meaning of Symbols

 WARNING	This symbol indicates information that if ignored, could result in personal injury or even death due to incorrect handling.
 CAUTION	This symbol indicates information that if ignored, could result in personal injury or physical damage due to incorrect handling.
 DANGER	This symbol indicates that the operation may cause electric shock.
PLEASE NOTE	Indicates information that is considered important, but not hazard-related.

1.3.1. Symbols on Equipment

The following types of warning, prohibition, and mandatory symbols are also used on the equipment.

Symbol	Description
	<p>Attention! The risk of chemical burns.</p> <p>If the battery is damaged or fails, it may lead to electrolyte leakage, which in turn causes the formation of a small amount of hydrofluoric acid, among other effects. Contact with these liquids can cause chemical burns.</p> <ul style="list-style-type: none"> ▪ Do not subject the battery module to severe impact. ▪ Do not open, disassemble or mechanically change the battery module. ▪ In case of contact with an electrolyte, wash the affected area with clean water immediately and seek medical advice promptly.
	<p>Attention! The risk of explosion.</p> <p>Incorrect operation or fire may cause the lithium-ion battery unit to ignite or explode, leading to serious injury.</p> <ul style="list-style-type: none"> ▪ Do not install or operate the battery module in explosive or high-humidity areas. ▪ Store the battery module in a dry place within the temperature range specified in the datasheet. ▪ Do not open, drill through or drop the battery cell or module. ▪ Do not expose the battery cell or module to high temperatures. ▪ Do not throw the battery cell or module into the fire. ▪ If there is a fire from the battery, please use the CO2 extinguisher. If there is a fire near the battery, please use a dry powder extinguisher. ▪ Do not use defective or damaged battery modules.
	<p>Caution! Hot surface</p> <ul style="list-style-type: none"> ▪ If a malfunction occurs, the parts will become very hot, and touching them may cause serious injury. ▪ If the energy storage system is defective, please shut it down immediately. ▪ If the fault or defect becomes obvious, special care should be taken when handling the equipment.
	<p>No open fire!</p> <p>It is prohibited to handle open flames and ignition sources near the energy storage system.</p>
	<p>Do not insert any objects into the opening in the housing of the energy storage system! No objects, such as screwdrivers, may be inserted through openings in the casing of the storage system.</p>
	<p>Wear safety goggles!</p> <p>Wear safety goggles when working on the equipment.</p>



Follow the manual!

When working and operating the equipment, the installation and operation manual provisions must be observed.

1.4. General Safety Information



WARNING

Failure to comply with the safety information can lead to life-threatening situations.

1. Improper use can cause death. Operators of High Voltage Series Battery must read this manual and observe all safety information.
2. Operators of High Voltage Series Battery must comply with the specifications in this manual.
3. This manual cannot describe all conceivable situations. For this reason, applicable standards and relevant occupational health and safety regulations are always given priority.
4. In addition, the installation may involve residual hazards in the following circumstances:
 - a. Incorrect installation.
 - b. The installation is carried out by personnel who did not receive relevant training or guidance.
 - c. Failure to observe the warnings and safety information in this manual.

If there are any questions, please contact Sunsynk support after service.

1.5. Disclaimer

Global Tech China Ltd shall not be liable for personal injury, property loss, product damage and subsequent losses under the following circumstances.

- Failure to comply with the provisions of this manual.
- Incorrect use of this product.
- Unauthorized or unqualified personnel repair the product, disassembly the rack and perform other operations.
- Use of unapproved spare parts.
- Unauthorized modifications or technical changes to the product.

1.6. Proper Use

- The battery energy storage system can only be installed and operated in an enclosed space. The working environment temperature range of High Voltage Series Battery is -20°C~ 55°C, and the maximum humidity is 85%. The battery module shall not be exposed to the sun or placed directly beside the heat source.
- The battery module shall not be exposed to a corrosive environment.
- When installing the battery energy storage system, ensure that it stands on a sufficiently dry and flat surface with sufficient bearing capacity. Without the manufacturer's written approval, the installation site's altitude shall not be higher than 2,000 meters. The output power of the battery decreases with the altitude.

- In areas where flooding may occur, care must be taken to ensure that the battery module is installed at a suitable height and to prevent its contact with water.
- The battery energy storage system must be installed in a fireproof room. This room must have no fire source and must be equipped with an independent fire alarm device, which complies with local applicable regulations and standards. According to local applicable regulations and standards, the room must be separated by the T60 fire door. Similar fire-proof requirements apply to other openings in the room (such as windows).

Compliance with the specifications in this manual is also part of proper use.

The use of the High Voltage Series Battery system is prohibited in the following circumstances:

- Mobile use on land or in the air (use on water only with the manufacturer's consent and with the manufacturer's written consent).
- Used in medical devices.
- Used as a UPS system.

1.7. Quality Certificate

The quality certificate can be downloaded from www.sunsynk.com.

1.8. Requirements for Installation Personnel

All work shall comply with local applicable regulations and standards.

The installation of High Voltage Series Battery can only be completed by electricians with the following qualifications:

- Trained in dealing with hazards and risks associated with the installation and operation of electrical equipment, systems, and batteries.
- Trained on installation and debugging of electrical equipment.
- Understanding and complying with the technical connection conditions, standards, guidelines, regulations, and laws applicable.
- Knowledge of handling lithium-ion batteries (transportation, storage, disposal, hazard source).
- Understanding and complying with this document and other applicable documents.
- Installation video of High Voltage Series Battery can be found at www.sunsynk.com or contact us via email: support@sunsynk.com

2. SAFETY

2.1. Safety Rules

To avoid property damage and personal injury, the following rules shall be followed when working on the hazardous live parts of the battery energy storage system:

- It is available for use.
- Ensure that it will not restart.
- Make sure there is no voltage.
- Grounding protection and short circuit protection
- Cover or shield adjacent live parts.

2.2. Safety Information

Part damage or short circuit may cause electric shock and death. A short circuit can be caused by connecting battery terminals, resulting in current flow. This type of short circuit shall be avoided under any circumstances. For this reason, follow these instructions:

- Use insulated tools and gloves.
- Do not put any tools or metal parts on the battery module or high-voltage control box.
- When operating the battery, be sure to remove watches, rings, and other metal objects.
- Do not install or operate this system in explosive or high-humidity areas.
- When working on the energy storage system, first turn off the charging controller, then the battery, and ensure that they are not turned on again.



WARNING

- Improper use of the battery energy storage system can lead to death. The use of the battery energy storage system beyond its intended use is not allowed, because it may cause great danger.
- Improper handling of the battery energy storage system can cause life-threatening risks, serious injury or even death.



CAUTION

Improper use can cause damage to the battery cell.

- Do not expose the battery module to rain or soak it in liquid.
- Do not expose the battery module to a corrosive environment (such as ammonia and salt).
- The battery energy storage system shall be debugged no later than six months after delivery.

3. TRANSPORT TO THE END CUSTOMERS

3.1. Provisions on Shipping of Battery Modules

It is necessary to comply with the relevant regulations and provisions on roads for shipping lithium-ion products in the corresponding countries.



It is prohibited to smoke in the vehicle during transportation or in the vicinity during loading and unloading.



The dangerous goods transport vehicles shall meet relevant regulations concerning road transportation and shall be equipped with two tested CO2 fire extinguishers.



It is forbidden for the freight forwarder to open the outer package of the battery module. Use only approved lifting equipment to move the battery cabinet system. Use only the hanging lug on the top of the battery cabinet as the connection point. When lifting, the angle of the sling must be at least 60°.



Improper vehicle transportation can cause injury. Improper transportation or improper transportation locks may cause the load to slip or overturn, resulting in injury. The cabinet shall be placed vertically to prevent it from sliding in the vehicle, and a fixing belt shall be used.



A tilting of the battery rack may cause injury. The maximum weight of a single battery rack of High Voltage Series Battery can reach 628 kg. When tilted, they may overturn, causing injury and damage. Ensure that the battery cabinet is on a stable surface and that it does not tilt due to load or force.



The battery energy storage system can be damaged, if not properly transported. The battery module can only be transported vertically. Note that these parts may be top-heavy. Failure to follow this instruction may result in damage to the part.



During transportation, the battery storage rack may be damaged when it is installed with the battery module. The battery storage rack is not designed to be transported with the installed battery modules. Always transport the battery module and the battery rack separately. Once the battery module is installed, do not move the battery rack, and do not lift it by a lifting device.



If possible, do not remove the transport packaging before arrival at the installation site. Before removing the transport protector, check if the transport packaging is damaged, and check the impact indicator on the outer packaging of the battery converter. If the impact indicator is triggered, the possibility of transport damage cannot be ruled out.



Improper transportation of battery modules may cause injury. The single battery module weighs 44 kg. If it falls or slips, it may cause injury. Only use suitable transport and lifting equipment to ensure safe transport.



Wear safety shoes to avoid the danger of injury. When transporting the battery rack and battery module, their parts may be crushed due to their heavy weight. Therefore, all persons involved in transportation must wear safety shoes with toe caps. Please observe the safety regulations for transportation at the end customer's site, especially during loading and unloading.



During transportation and installation of unpacked battery storage cabinets, the risk of injury increases, especially on sharp metal panels. Therefore, all personnel involved in transportation and installation must wear protective gloves.



The maximum weight of a single rack of High Voltage Series Battery can reach 628 kg. We suggest that at least 2-3 people work together to install the battery rack. The lifting device is helpful for heavy parts, and the pulley or cart for light parts. Be careful not to damage the case. The number of battery modules stacked shall not be more than 8.

Check whether the delivery is complete.

3.2. Permissible and Impermissible Storage Positions of a Packaged

3.2.1. Battery Module

The battery module can only be transported in an upright position. Please note that the battery rack may be very top-heavy.



4. PREPARATION

4.1. Tools Required

Tool	Use
PHILIP2# crosshead screwdriver	<ul style="list-style-type: none"> ▪ Fix the upper and lower tripods to the side beam and the cross beam. ▪ Install and connect the side beam/cross beam. ▪ Fix the L-shaped bracket to the side beam. ▪ Fix the base assembly to the side beam. ▪ Fix the diagonal brace to the beams on both sides. ▪ Fix the base to the side or cross beam. ▪ Install the ground wire. ▪ Install the hanging lug on the battery module/high-voltage control box. ▪ Fix the battery module and the high-voltage control box on the rack.
10mm hexagon socket	<ul style="list-style-type: none"> ▪ Fix the expansion screw.
24mm wrench	<ul style="list-style-type: none"> ▪ Adjust the height of the base and tighten the nut.

4.2. Auxiliary Tools and Materials Required

AID/Material Auxiliary tools/Materials	Use
Fastening materials (M4*12 M6*12 screws, M6*100 expansion screws, M6 nuts)	<ol style="list-style-type: none"> 1. Assemble the battery racks and fix them on the wall or connect the two racks. 2. Assemble the battery modules and high-voltage control boxes, and fix them to the racks.

5. DESCRIPTION AND INSTALLATION

5.1. Installation Precautions



CAUTION

Possible damage to the building due to static overload.

1. The total weight of the battery storage system is 628kgs. Ensure that the installation site has sufficient bearing capacity.
2. When selecting the installation site, consider the transportation route and necessary site cleanup.

5.2. Product Description

High Voltage Series Battery is a high-voltage lithium-ion battery system. It provides a reliable backup power supply for supermarkets, banks, schools, farms and small factories to smooth the load curve and achieve peak load transfer. It can also improve the stability of renewable systems and promote the application of renewable energy.

It is characterized by high integration, good reliability, long service life, wide working temperature range, etc. The battery energy storage system is modular. Each battery module boasts a capacity of 5.12 kWh. The complete system supports 12 battery modules in series, your total energy capacity reaching an impressive 61.44 kWh - perfect for any large scale installations.

5.3. Technical Data

Performance	
Battery System Energy (12 battery modules)	61.44 kWh
Charge/Discharge Rate (Max)	1C
Max Charge / Discharge Current	100 A
Module Capacity	100 Ah
Working Voltage	538~691 V
Working Temperature	Charge: 0~55 °C / Discharge: -20~55 °C
General Specification	
Battery cell chemistry	Lithium Ferro Phosphate (LifePO4 or LFP)
Dimension (W×D×H mm)	13th floor: 589×590×2240
Weight Total (12 battery modules, 1 rack)	628 Kg
Weight of each battery module / battery rack	44 - 85 Kg
The altitude of the Installation site	≤2000m
Humidity	5%~85% (RH)
Warranty Period	10 years
Case protection grade	IP20
Certification	CE/IEC62619/UN38.3

5.4. Description of Rack

Type A:

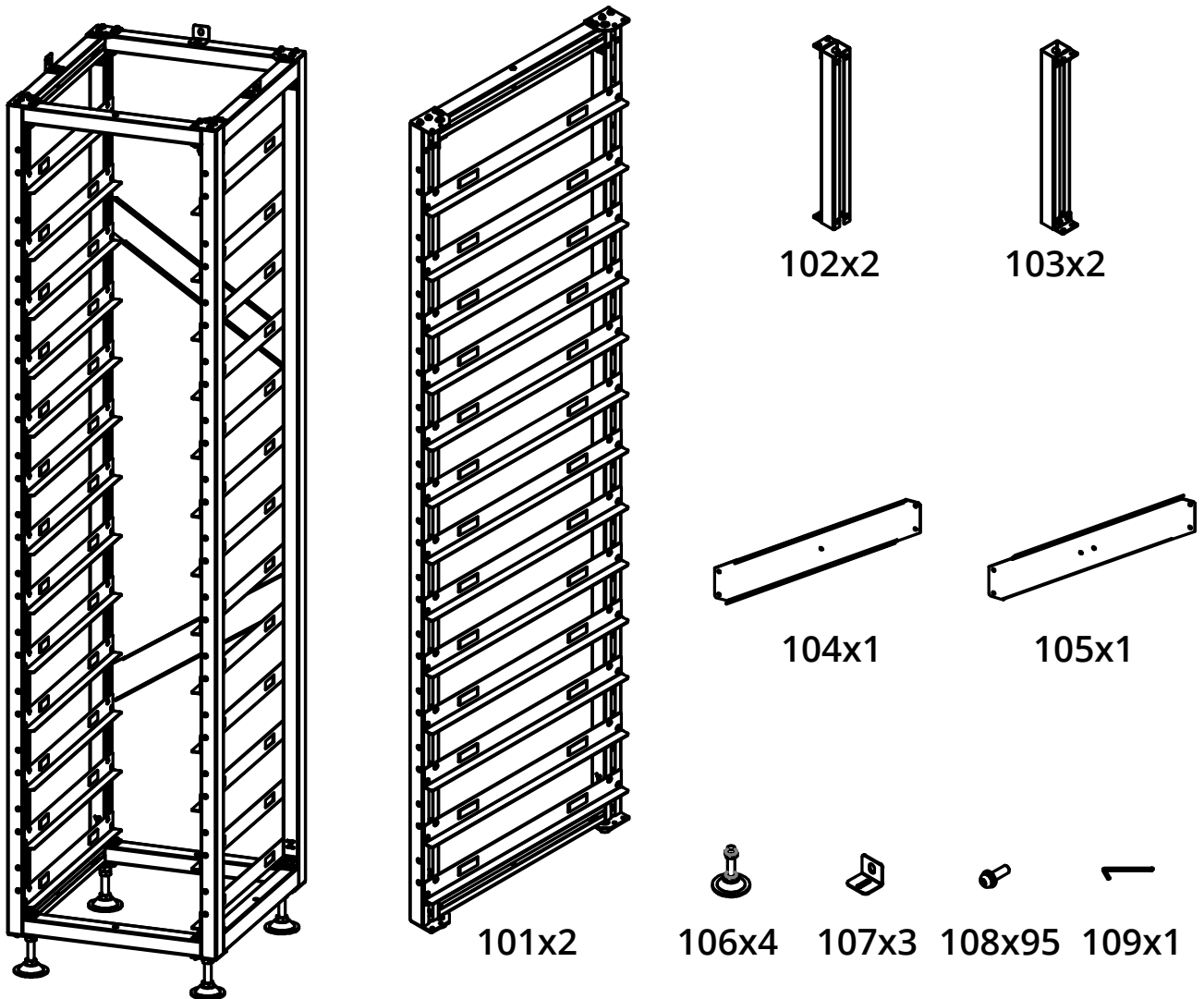

No.	Description
101	Side
102	Upper Cross beam
103	Lower cross beam
104	Lower diagonal beam
105	Upper diagonal beam
106	Base
107	L-bracket
108	M6*12 outer hexagon cross combination screw
109	Hex key

Type B:

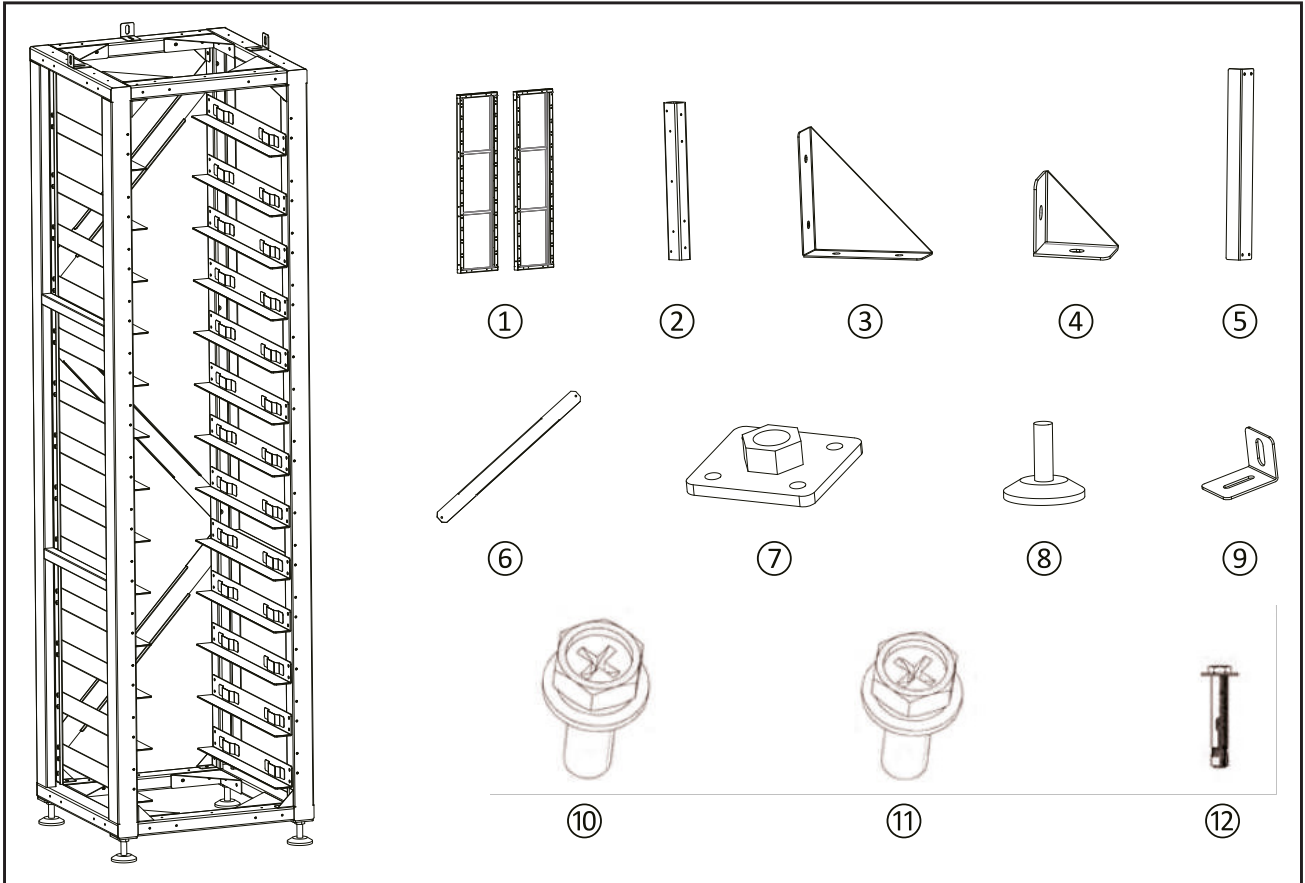

No.	Description
1	Side beam
2	Cross beam
3	Big tripod
4	Small tripod
5	L-bracket assembly
6	Diagonal brace
7	Bottom plate parts
8	Base
9	Rack fastener
10	M4*12 outer hexagon cross combination screw
11	M6*12 outer hexagon cross combination screw
12	M6*100 expansion screw

5.5. Installation of Rack

Type A:

1. Connect the upper cross beams (102) and lower cross beams (103) with the two rack sides (101) using M6*12 external hexagonal cross combination screws (108) and a PHILIP2 # screwdriver.

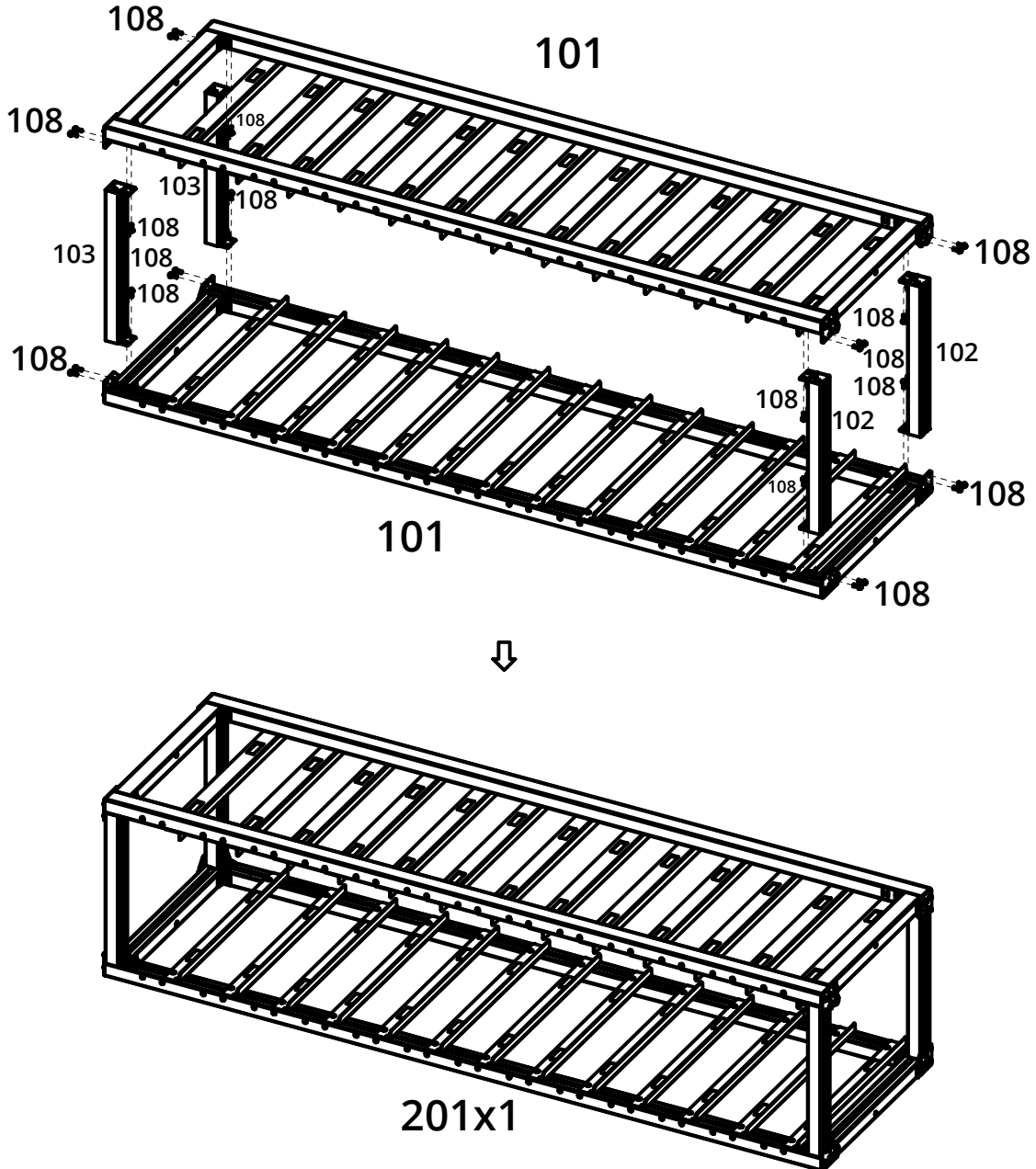

1. Use a PHILIP2 # screwdriver and M6*12 external hex combination screws (108) to attach the L-bracket (107) assembly horizontally to the side joist.
2. Attach the upper diagonal beam (105) to two side beams (101) and the lower diagonal beam (104) to two other side beams using M6*12 external hex combination cross screws (108) and a screwdriver.
3. Screw the base (106) to the rack bottom plate and secure it with a PHILIP2# screwdriver or by hand.
4. To fix the rack on the wall, use a PHILIP2# screwdriver to install the rack fastener at the M6 screw hole above the rack and fix it with M6*12 outer hexagon cross combination screws (108). Fix the other side of the rack with the wall using M6*100 expansion screws. To fix two racks together, install the rack fastener at the M6 screw hole above the rack, and fix them together with M6*12 outer hexagon cross combination screws and M6 nuts.

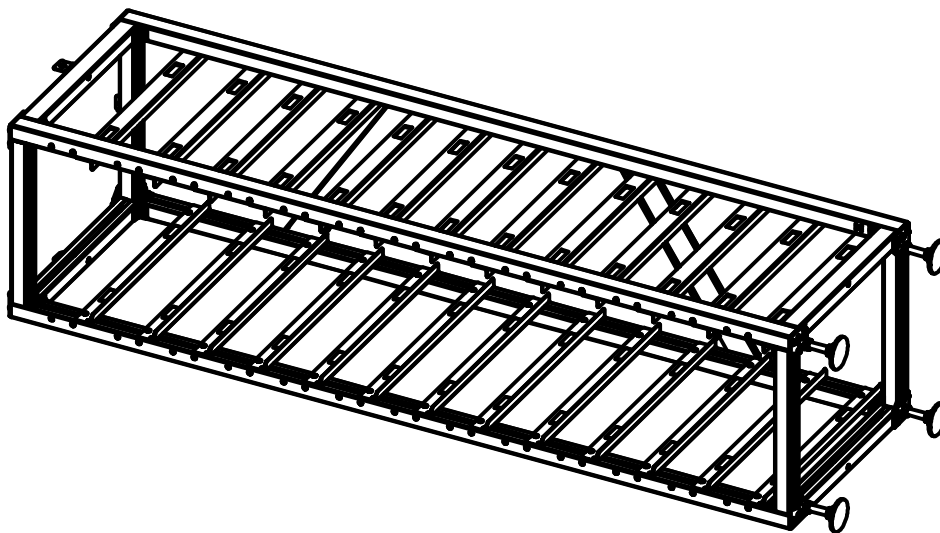
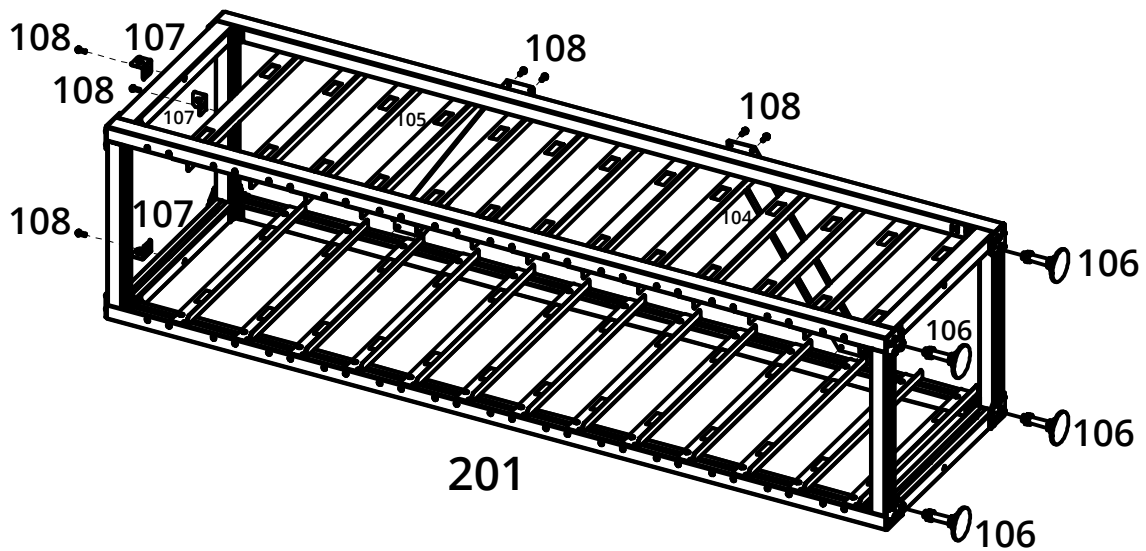

Type B:

1. Take out two side beams and upper and lower crossbeams to form a rectangular frame, connect with side beams and crossbeams using big tripods and small tripods, and then fix big and small triangular supports with side beams and crossbeams using M6*12 outer hexagon cross combination screws and a PHILIP2 # screwdriver.
2. Use a PHILIP2 # screwdriver and M6*12 outer hexagon cross combination screws to fix the L-bracket assembly horizontally on the side beam.
3. Fix the diagonal brace on two side beams using M6*12 outer hexagon cross combination screws and a screwdriver.
4. Fix the four bottom plates on four corners of the lower rack using the M6*12 outer hexagon cross combination screws and a PHILIP2# screwdriver.
5. Screw the base into the bottom plate and fix it with a PHILIP2# screwdriver or by hand.
6. To fix the rack on the wall, use a PHILIP2# screwdriver to install the rack fastener at the M6 screw hole above the rack and fix it with M6*12 outer hexagon cross combination screws. Fix the other side of the rack with the wall using M6*100 expansion screws. To fix two racks together, install the rack fastener at the M6 screw hole above the rack, and fix them together with M6*12 outer hexagon cross combination screws and M6 nuts.

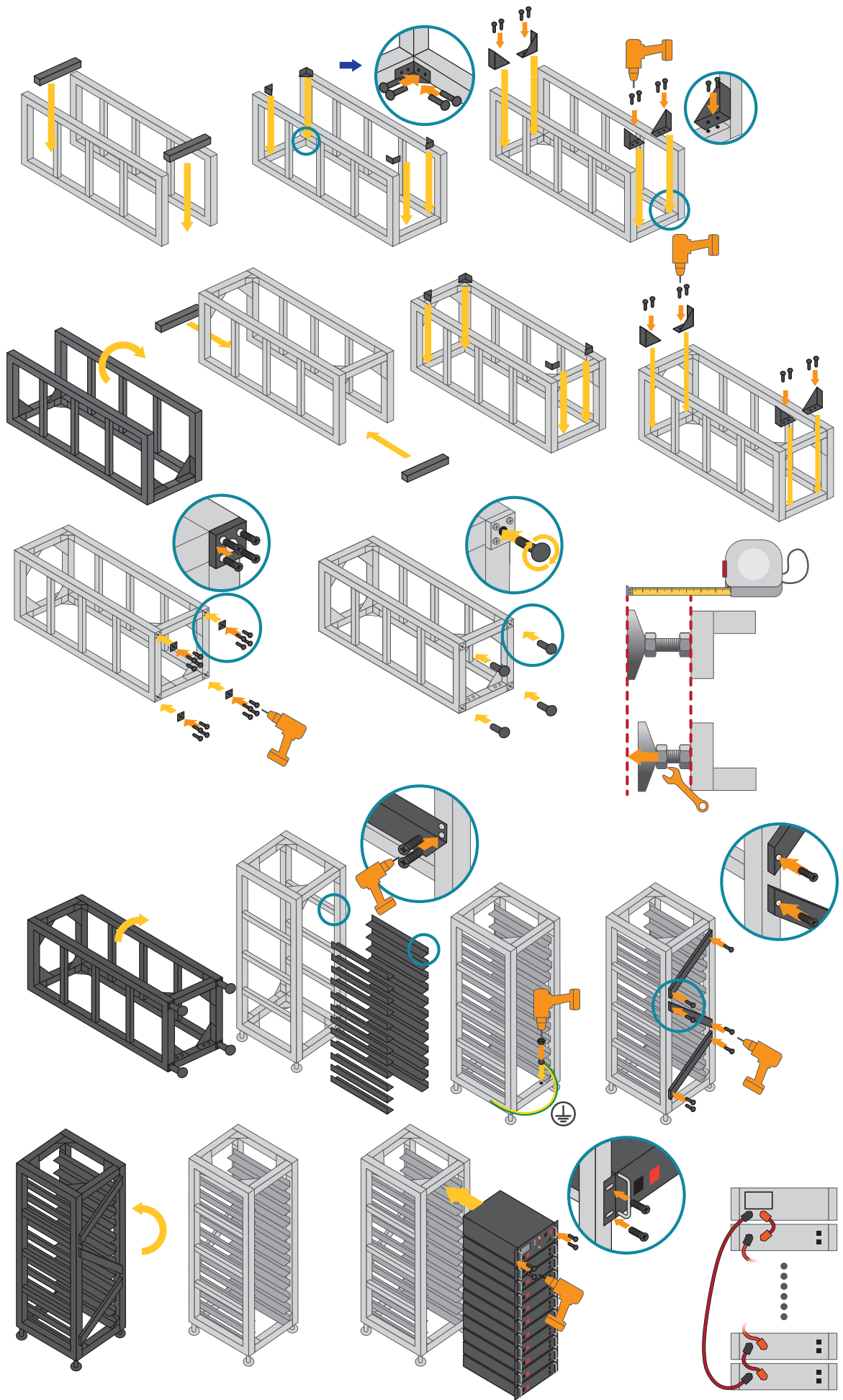

5.6. Description of Battery Module

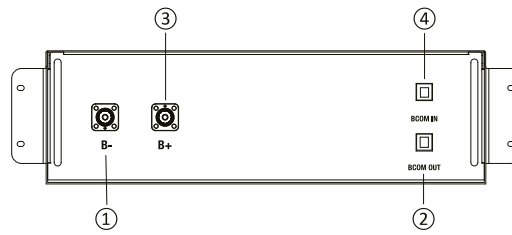

No.	Name	Description
1	B-	Battery module negative pole (black)
2	BCOM OUT	Connection position of battery module communication and power supply output
3	B+	Battery module positive pole (orange)
4	BCOM IN	Connection position of battery module communication and power supply input

5.7. Description of High-Voltage Control Box

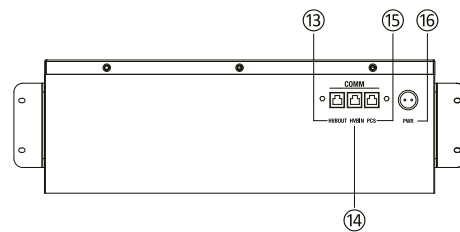
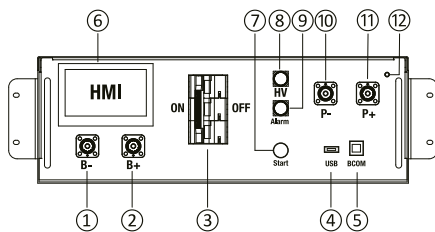

No.	Name	Description	Position
1	B-	Connection position of the common negative pole of the battery (black)	Front
2	B+	Connection position of the common positive pole of the battery (orange)	Front
3	Air switch	Used to manually control the connection between the battery rack and external devices	Front
4	USB	BMS upgrade interface and storage expansion interface	Front
5	BCOM	Communicative connection with the first battery module and providing 12VDC power for the first battery module	Front
6	Human-machine interface (HMI)	Display some important battery information	Front
7	START	A start switch of 12VDC power inside the high-voltage control box	Front
8	HV light indicator	High-voltage hazard indicator (yellow)	Front
9	ALARM light indicator	Battery system fault alarm indicator (red)	Front
10	PCS -	Connection position of PCS negative pole (black)	Front
11	PCS+	Connection position of PCS positive pole (orange)	Front

No.	Name	Description	Position
12	Grounding wire identification	Connection to the battery rack and the ground point	Front
13	OUT COM	Connection position with next HVB-100A750V communication input	Rear
14	IN COM	Connection position with previous HVB-100A750V communication input	Rear
15	PCS COM	Communication interface with charging and discharging equipment	Rear
16	POWER	Connection position of external 12VDC power supply	Rear

5.8. Description of Battery Module in Rack

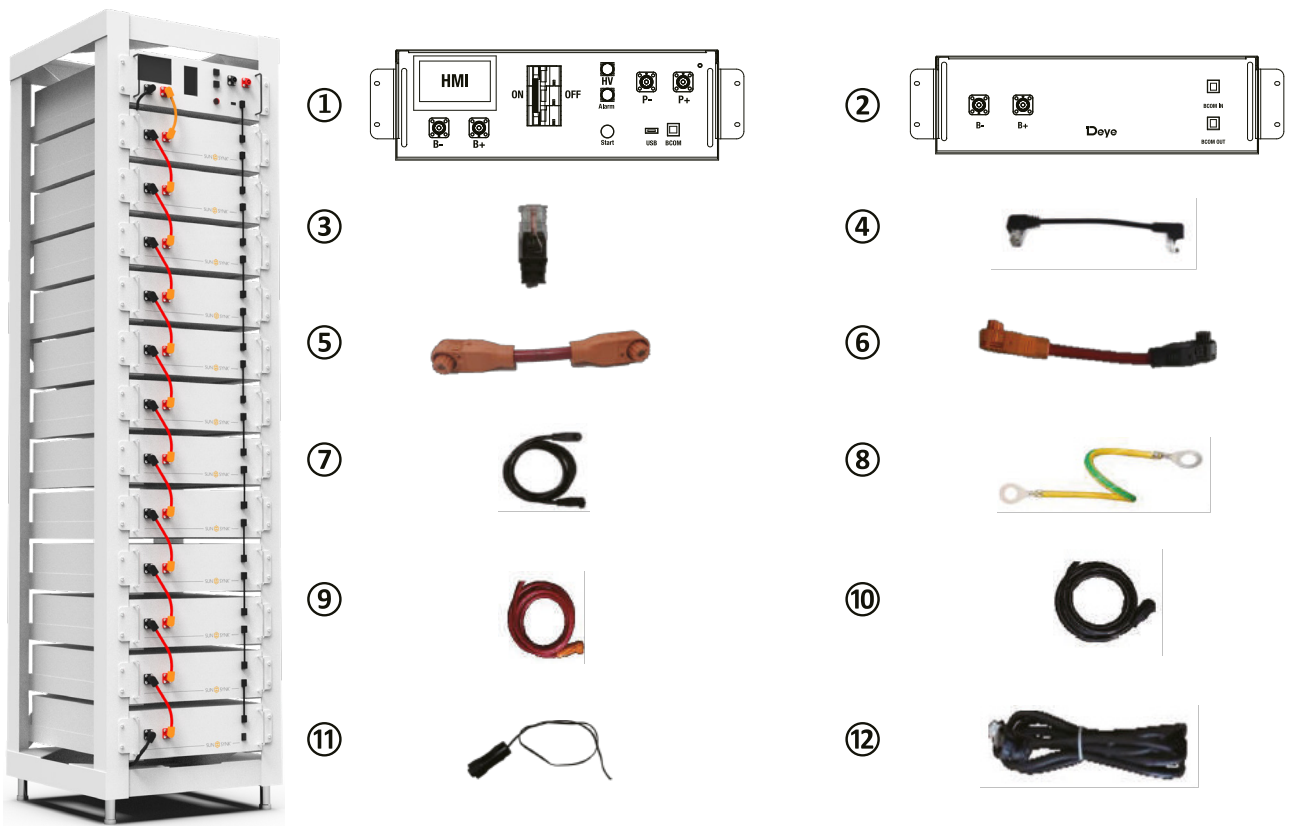

No.	Description	Type
1	High-voltage control box 750V/100A	
2	5.12kWh battery module (general)	
3	120ohm terminal resistor	
4	Communication cable (110mm for battery module, 140mm for high-voltage control box)	Standard
5	220mm positive power cord of high-voltage control box	Standard
6	220mm positive power cord of battery module	Standard
7	The negative power cord of the high-voltage control box	Standard
8	140mm ground wire A (ground wire B for external connection of battery rack is not provided)	Standard connecting cable A (connecting the high-voltage control box)

No.	Description	Type
9	Connected to external PCS positive power cord (EPCable5.0)	Optional
10	Connected to external PCS negative power cord (ENCable5.0)	Optional
11	Connected to external 12V power cord (EPWRCable5.0)	Optional
12	Connected to external device communication cable (ECOM Cable5.0)	Optional

The following table presents the definition for PCS, IN, and OUT connection pins. All use the same pin number sequence shown in the next image:

Pin No.	PCS Port Definition	IN Port Definition	OUT Port Definition	Definition of Power
1	485B-	BMS_CANL	BMS_CANL	12V
2	485A+	BMS_CANH	BMS_CANH	GND
3	--	DI+	DO2+	--
4	PCANL	DI-	DO-	--
5	PCANH	--	--	--
6	--	--	--	--
7	485A+	--	--	--
8	485B-	--	--	--

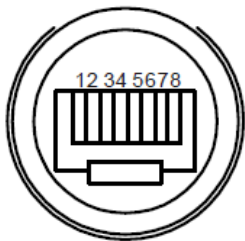

The following table presents the definition of the high-voltage control box interface PCS, IN, and OUT connection pins. All use the same pin number sequence shown in the next image:

Pin No.	BMS-BMU Port Definition	Upper BMU Port Definition	Lower BMU Port Definition
1	BMU_CANL	BMU_CANL	BMU_CANL
2	BMU_CANH	BMU_CANH	BMU_CANH
3	DO+	DI+	DO+
4	DO-	DI-	DO-
5	GND	GND	GND
6	GND	GND	GND
7	12V	12V	12V
8	12V	12V	12V

5.9. Installation of the Battery Module to the Rack



DANGER

Insufficient or no grounding may cause an electric shock. Device malfunctions, and insufficient or no grounding may cause device damage and life-threatening electric shocks.

PLEASE NOTE

Before installing the battery, please turn the manual switch of the high-voltage control box to the off position.

1. Install the lug on the battery module and high-voltage control box.
2. Insert the first battery module into the battery module rack at the bottom cluster rack; then in the order from bottom to the top, continue the instalment in the same way till it reaches the twelfth floor. On the thirteenth floor, insert the slide of the cabinet at the top of the rack into the high-voltage control box.
3. After the battery module and control box is inserted into the rack, use M4*12 outer hexagon cross combination screws to fix all the lugs of the battery module and control box on the side beam in turn.
4. After the battery module is placed in the control box, take out a 140 mm communication cable to connect the communication port of the battery module and the high-voltage control box, and 11x110mm communication cables to connect the battery module communication port (IN-OUT) from top to bottom. (12 communication cables in total). **The communication port (OUT) of the battery module at the bottom is not connected to the communication cable. Instead, this port is sealed with a 120ohm terminal resistor.**
5. Take out a 220 mm positive power cord and connect the positive pole of the battery module at the top to the positive pole of the high-voltage control box. Take out 11x200mm battery module power cords and connect the power ports (B- to B+) in a top to bottom order to form a series circuit. For aesthetics, connect the negative power pole of the first battery module to the negative power pole of the high-voltage control box from the bottom of the battery module to the back of the rack. On the back of the rack, a plane-head-shaped tie is used to secure the cable harness. (12 power cords in total).
6. Take out the external positive power cord EPCable5.0 and external negative power cord ENCable5.0, and plug them into PCS interfaces, respectively.
7. Take out the ground wire A and connect one end of it to the M4 rivet nut of the high-voltage control box panel, and the other end to any M6 screw hole of the cross beam above the rack. Take out the ground wire B (user need to prepare in advance) and connect one end of it to any M6 screw hole of the cross beam under the rack, and the other end to the customer's grounding point. (The length of the ground wire B is determined based on the customer's condition.)

5.10. Startup Steps of High Voltage Series Battery

After connecting the battery cables, press the air switch button on the high-voltage control box to turn OFF to ON, and then press the START button. After the screen lights up, wait for about 8 seconds until the yellow HV light indicator comes on. (The specific working time is subject to the HV light indicator's lighting-up time.)

5.11. External 12V Power Supply of High-Voltage Control Box

To operate the high-voltage control box with an external 12V power supply, please contact our service personnel. Hotline: +852 2884 4318, Email: support@sunsynk.com.

In the factory configuration, the high-voltage control box is supplied with working voltage from an internal power supply unit. If your plan requires an external 12V power supply, an adaptive version and a high-voltage control box can be provided as requested. Please contact our after-sales service personnel for details.





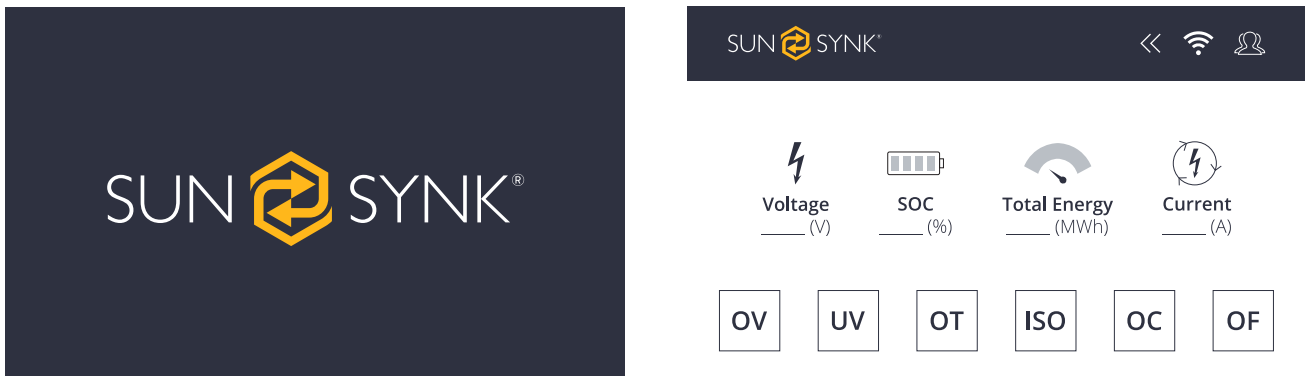

6. DISPLAY

6.1. Home Screen

The default interface will appear after powering on. If the screen is not touched for more than 13 minutes, it will darken and the default interface replaces the other interface. Click this screen to enter the user interface.



6.1.1. Basic Parameters

 Wi-Fi Icon	<ul style="list-style-type: none"> No Wi-Fi icon on the screen indicates no Wi-Fi signal. The flashing Wi-Fi icon on the screen indicates the Wi-Fi is in connecting. The Wi-Fi icon on the screen indicates the Wi-Fi is connected.
 System maintenance icon	Click this icon to enter the system maintenance.
 Voltage	Total battery voltage.
 Current	Battery current, the positive value representing discharge, the negative value representing charge.
 SOC	Battery remaining energy.
 Total energy	Accumulated discharging energy.

6.1.2. Fault Indication

When the corresponding fault type occurs, the red background indicator on the screen will light up. The description of each is shown below.

OV	Over Voltage
UV	Under Voltage
OT	Over Temperature
UT	Under Temperature
ISO	Insulation failure, there is a risk of current leakage
OC	Over Current
OF	Other Faults
DV	Different Voltage
DT	Different Temperature

6.2. System Maintenance

Click the  icon on screen to enter the maintenance system password confirmation interface.



Enter the password and press the Confirm key to enter the main interface of system maintenance. The operation shall be performed by a professional.



6.2.1. Main Screen

This screen shows the main information of the system, like the Voltage (V), SOC (%), Current (A), Total Energy (MWh), the BMU number, and the protocol ID. Click this screen to enter the system maintenance menu. Click on each Fault Indication to enter the Fault Page.

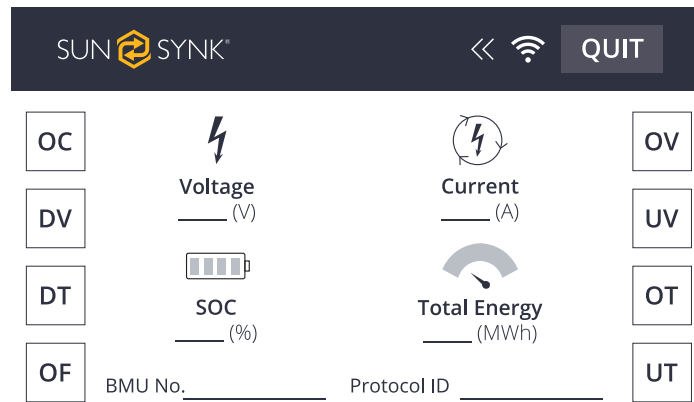

6.2.2. System Maintenance Menu

The Menu page presents information about High Voltage Series Battery system, voltage, temperature, version, and the relay status.

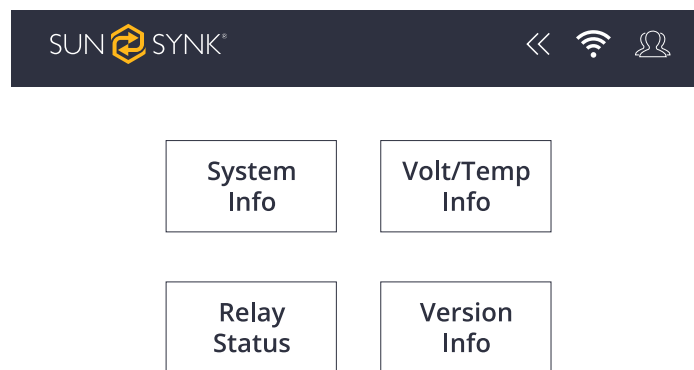

6.2.2.1. System information

This screen shows the information about the High Voltage Series Battery system. Information like product series, number of the BMS, the system status, parallel status, power status, battery life status, and sub status.

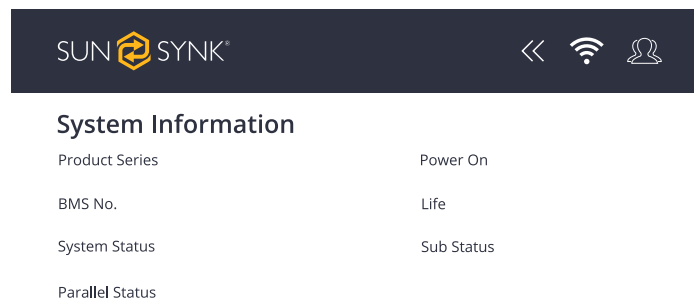

6.2.2.2. Volt/Temp information

This screen shows the information about the system voltage and temperature.

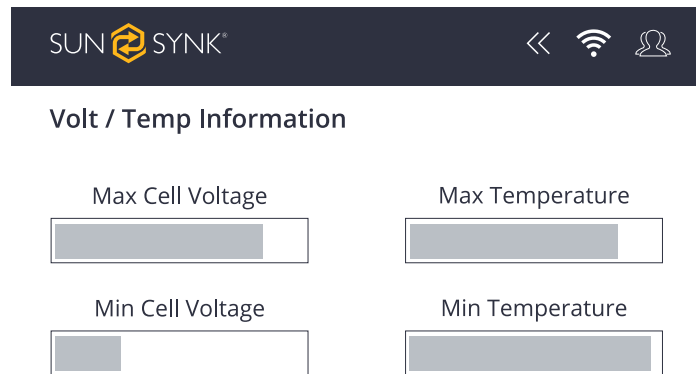

6.2.2.3. Relay status

This screen shows statuses related to the relay. In addition, in this page you can clear the relay adhesion.

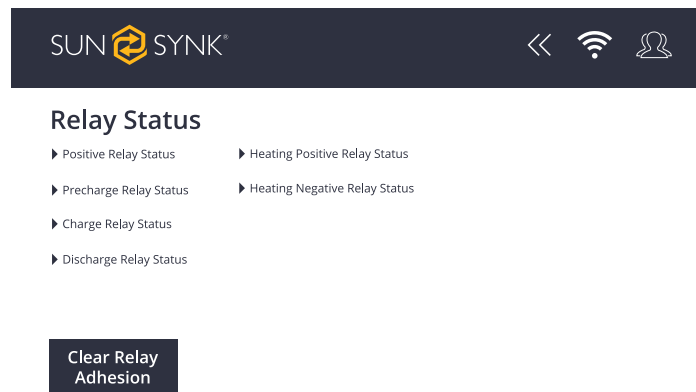

6.2.2.4. Version information

This page contains all the information about BMS, BMU, and Screen software and hardware versions.

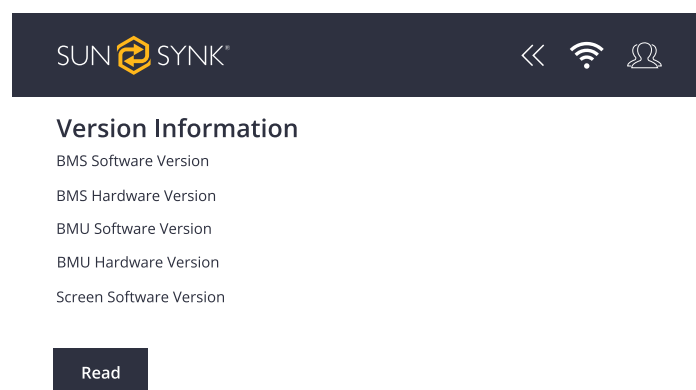

6.2.3. Fault Pages

In "Home Screen" page, click on each Fault Indication to enter in the Fault Page related.

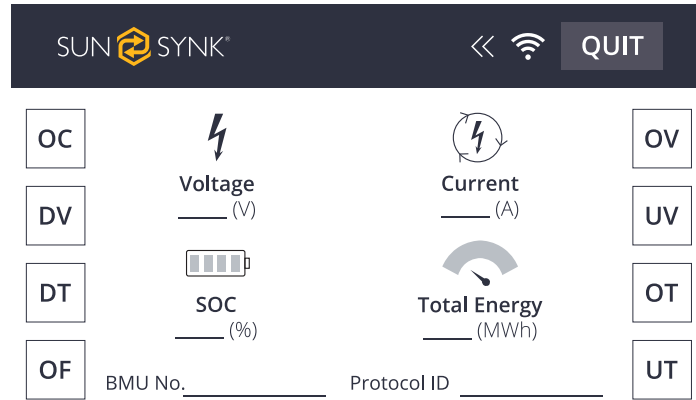

6.2.3.1. Under Voltage (UV)

This screen shows the faults related to the under voltage of the system.

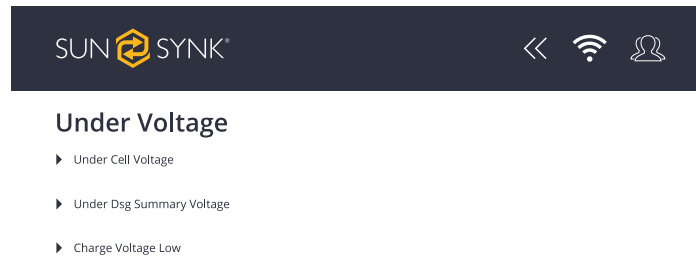

6.2.3.2. Over Voltage (OV)

This screen shows the faults related to the over voltage of the system..



6.2.3.3. Under Temperature (UT)

This screen shows the faults related to the under temperature of the system.

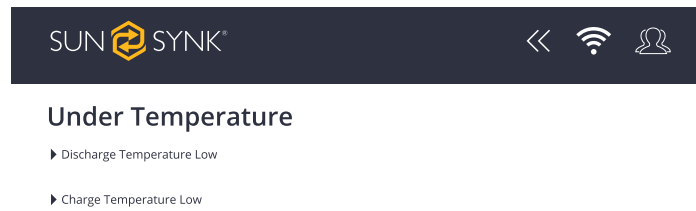

6.2.3.4. Over Temperature (OT)

This screen shows the faults related to the over temperature of the system.

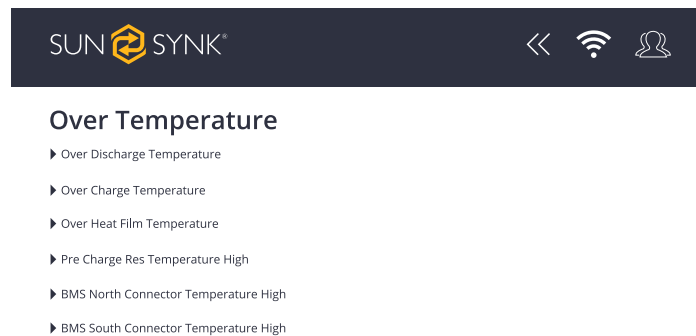

6.2.3.5. Over Current (OC)

This screen shows the faults related to the over current of the system.



6.2.3.6. Different Voltage (DV)

This screen shows the faults related to the different voltage of the system.



6.2.3.7. Different Temperature (DT)

This screen shows the faults related to the different temperature of the system.

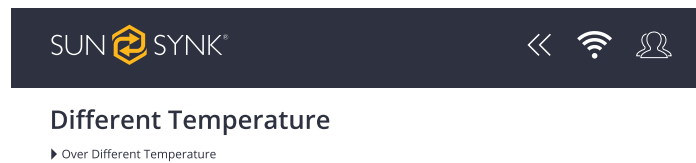

6.2.3.8. Other Faults (OF)

This screen shows the other faults of the system.

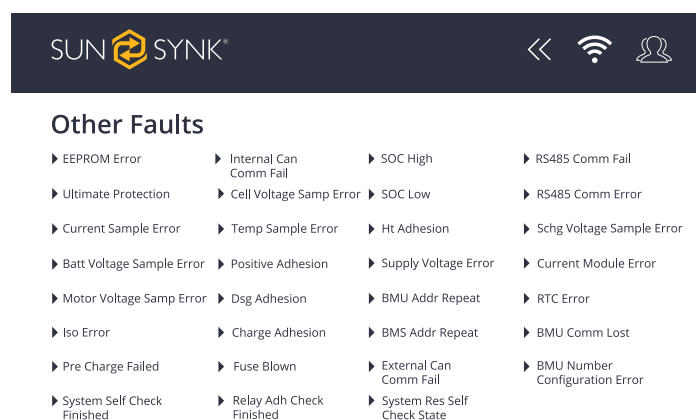

6.2.4. Maintenance Interface

For safety, please unplug the power cord of the positive and negative interfaces before maintenance.



PLEASE NOTE

When inserting the SD card, unplug the battery power cord and manually turn the air switch to the off position.

7. INSTRUCTIONS FOR HVESS-MONITOR USE

7.1. Main Page

The screenshot shows the SUN SYNK HVESS-MONITOR main page. The interface includes a sidebar with navigation options: GENERAL (Base Info, Parallel Info, HISTORY, Statistics, History Data, SETTINGS, BMS Parameter, BMU Parameter, Firmware, Manufacture), PCS (Info), and buttons for TYPE (USBCAN_E, USBCAN1) and OPEN PCS CAN BUS. The main area displays battery status (BATT TYPE: EVE 100Ah, STATUS: Static, SUB_STATUS: 249), SOC (49.7%), VOLTAGE (365.1Vdc), CURRENT (0.0Aac), POWER (0.000Kw), TOTAL ENERGY (0.00MWh), and HEALTH (100.0%). It also shows a table of cell voltages and temperatures for EMU01 through EMU08, and a list of status indicators like Positive, Precharge, Discharge, Charge, Battery Pos, Battery Neg, and Exit.

7.2. Function List

No.	Communication Category	Function Category	Function Name	Function Description	
1	INTER-CAN BUS	Communication configuration	Communication configuration of CAN BUS	"INTER-CAN BUS" or "PCS CAN BUS" can be selected Click the relevant button to start or stop the communication with BMS.	
2		Data display	Basic Information	1. Monitoring the total voltage, current, SOC, and other core information 2. Monitoring relay switch information and other general information 3. Monitoring the voltage and temperature of the cell by BMU 4. Display the current alarm of the system by category	
3		History data	History data	Support display of a maximum of 50 parallel devices information Not available temporarily	
4		History record	History record	History record	Read history information stored in BMS
5			History event	History event	Read history event information stored in BMS

No.	Communication Category	Function Category	Function Name	Function Description
6	INTER-CAN BUS	HV ESS-Monitor storage	Real-time data storage of HV ESS-Monitor	Operation data stored real-time in backstage of HV ESS-Monitor
7	INTER-CAN BUS	Parameter	BMS parameter BMU parameter	Read the current parameters displayed, including the cell's overcharge, the system's overcharge, the cell's over-discharge, the system's system over-discharge, charging overcurrent, discharging overcurrent, charging under temperature, discharging under temperature, charging overtemperature, discharging under temperature, differential voltage, etc.
8		Firmware	INTER-CAN BUS firmware update	Upgrade BMS and BMU via INTER-CAN BUS
9		Manufacture	Manufacture	Extract relevant information such as product serial number
10	PS CAN	Inverter information	Information	Read and display inverter and parallel device information
11		Firmware	PCS CAN BUS firmware update	Upgrade BMS and BMU via PCS CAN BUS

7.3. Function Description

7.3.1. CAN Communication Configuration

1. Insert the network cable into IN port, click the OPEN INTER-CAN BUS button to start the INTER-CAN communication, and click the button again to stop such communication.
2. Insert the network cable into the PCS port, click the OPEN PCS CAN BUS button to start the INVERTER CAN communication, and click the button again to stop such communication.

TYPE	USBCAN2	TYPE	USBCAN2	TYPE	USBCAN1
OPEN INTER-CAN BUS		CLOSE INTER-CAN BUS		OPEN INTER-CAN BUS	
TYPE	USBCAN_E	TYPE	USBCAN_E	TYPE	USBCAN_E
OPEN PCS CAN BUS		CLOSE PCS CAN BUS		OPEN PCS CAN BUS	

7.3.2. Basic Information

The default mode is **Factory Mode**. To display detailed information, change to **Debug Mode** and click the **Set** button.

Product Serial Code

Software Version	LVNG09622524N1T	Read
Hardware Version	LVESS01	Read
Serial Number	YD20210520001	Read
Model Number		Read
Time Calibration	OK	
History Energy	Clear Mos Short Circuit Fault	
Operation	Debug Mode	<input type="checkbox"/> To All Set
Power On Count	168	Read
Battery Type	GOTION 96Ah	Read
PCS Type	Sol-ark	Read Set

In the parallel system application, click the OPEN INTER-CAN BUS button. By default, the data monitoring interface will display the real-time information of the module group number 01. To display other module information, switch to the desired module group number.

After the communication is available, the specific cell number and temperature information will be displayed in real-time. The HVES-Monitor displays different alarms. There are protection events and alarm events. Both types of events are displayed in the list. When an alarm event disappears, it will be removed from the list.

The screenshot displays the SUN SYNK HVES-Monitor interface for Group 01. The interface includes a navigation menu on the left, a top status bar, and a main monitoring area with various data panels.

Top Status Bar: Group 01, Life: 161, PROTECTION (Red), ALARM (Yellow), 2023, 00:10.

Left Navigation Menu: GENERAL, Base Info, Parallel Info, HISTORY, SETTINGS, PCS, Info.

Main Monitoring Area:

- BATT TYPE:** EVE 100Ah
- STATUS:** Static
- SUB_STATUS:** 249
- STATUS Table:**

Inter Volt	365.1V
Outer Volt	547.4V
Charge Volt	0.0V
ChglnStatus	OFF
Board Temp	35°C
Rrechg_Res_T	27°C
ConnectorP_T	27°C
ConnectorN_T	27°C
Supply Volt	11.6V
DI	OFF
DO	ON
DO2	ON
Charge Cycle	7
Total Charge	0.00Ah
Total Discharge	504.08Ah
- SOC:** 49.7%
- POWER:** 0.000Kw
- Cell Voltage:** 365.1Vsc
- Cell Temperature:** 0.0Abc
- Max Cell Voltage:** 3.274V (3-4)
- Min Cell Voltage:** 3.266V (1-2)
- Max Temperature:** 25°C (1-4)
- Max Cell Voltage:** 24°C (1-1)
- Cell Data Table:**

EMU01 [111]	EMU02 [111]	EMU03 [111]	EMU04 [111]	EMU05 [111]	EMU06 [111]	EMU07 [000]	EMU08 [000]
Volt_01	1.268V	Volt_02	1.266V	Volt_03	1.269V	Volt_04	1.268V
Volt_05	1.270V	Volt_06	1.270V	Volt_07	1.268V	Volt_08	1.270V
Volt_09	1.270V	Volt_10	3.272V	Volt_11	1.270V	Volt_12	1.268V
Volt_13	3.272v	Volt_14	3.270V	Volt_15	3.270V	Volt_16	3.270V
Temp_01	24°C	Temp_02	24°C	Temp_03	24°C	Temp_04	25°C
Temp_05	24°C	Temp_06	24°C	Min Temp	24°C	Min Temp Pos	1
Max Temp	25°C	Max Temp Pos	4	Min Volt	3.266V	Min Volt Pos	2
Max Volt	3.272V	Max Volt Pos	13	ConnectorP_T	0°C	ConnectorN_T	0°C
DI	ON	DO	ON	Supply Volt	12.8V	Soft Version	22071301
Summary Volt	52.3V	Inner Temp	30°C				
Hard Version	HVMU01						

Control Buttons: TYPE USBCAN_E, CLOSE INTER-CAN BUS, TYPE USBCAN1, OPEN PCS CAN BUS.

Settings: Positive (OFF), Precharge (OFF), Discharge (OFF), Charge (OFF), Battery Pos (OFF), Battery Neg (OFF), Exit (ON).

7.3.3. Parallel Information

In the parallel info display interface, the real-time information of racks that are parallel to each other is displayed successively according to the serial number.

Group: 01 Life: 161 PROTECTION: 2023 ALARM: 00:10

	SysStatus	Life	Parallel	PowerOn	Voltage(v)	SOC(%)	Current(A)	Positive	Precharge	Discharge	Charge	Heater Pos	Heater Neg	BMU	MaxChgCur(A)	MaxDs
01	Static	124	OFF	Power On	365.1	49.7	D.0	OFF	OFF	OFF	OFF	OFF	OFF	ON	96.0	10
02	Offline															
03	Offline															
04	Offline															
05	Offline															
06	Offline															
07	Offline															
08	Offline															
09	Offline															
10	Offline															
11	Offline															
12	Offline															
13	Offline															
14	Offline															
15	Offline															
16	Offline															
17	Offline															
18	Offline															
19	Offline															
20	Offline															

7.3.4. History Data

This page is not available temporarily.

7.3.5. History Records

Select Records and click the READ ALL button. The HVES-Monitor starts the task of reading history records and creates the reading process with the slave computer. After receiving the response, the received history records will be analysed and displayed in the Flash record list. The latest history records are displayed below the list. Click the SAVE button to save the read history records to the user selected path for offline analysis.

Group: 01 Life: 161 [More Info.](#) PROTECTION 2023 ALARM 00:10

History Records

	Date	Time	SlaveNo	SumVolt(V)	Curr(A)	ChainCapacity	SOC(%)	SOH(%)	DiffVolt(V)	MaxCellV(V)
1	2022-08-10	18:21:45	1	366.3	0.0	49.75	50.0	100.0	0.008	3.286
2	2022-08-10	18:24:00	1	366.3	0.0	49.75	50.0	100.0	0.008	3.286
3	2022-08-10	18:28:14	1	366.3	0.0	49.75	50.0	100.0	0.008	3.286
4	2022-08-10	18:30:16	1	366.3	0.0	49.75	50.0	100.0	0.008	3.286
5	2022-08-10	18:32:18	1	366.3	0.0	49.75	50.0	100.0	0.008	3.286
6	2022-08-10	18:32:18	1	366.3	0.0	49.75	50.0	100.0	0.008	3.286
7	2022-08-10	18:41:29	1	366.3	0.0	49.75	50.0	100.0	0.008	3.286
8	2022-08-10	18:45:01	1	366.3	0.0	49.75	50.0	100.0	0.008	3.286
9	2022-08-10	18:47:03	1	366.3	0.0	49.75	50.0	100.0	0.008	3.286
10	2022-08-10	18:49:05	1	366.3	0.0	49.75	50.0	100.0	0.008	3.286
11	2022-08-10	18:51:07	1	366.3	0.0	49.75	50.0	100.0	0.008	3.286
12	2022-08-10	18:53:09	1	366.3	0.0	49.75	50.0	100.0	0.008	3.286
13	2022-08-10	18:55:11	1	366.3	0.0	49.75	50.0	100.0	0.008	3.286
14	2022-08-10	18:57:13	1	366.3	0.0	49.75	50.0	100.0	0.008	3.286
15	2022-08-10	18:59:55	1	366.3	0.0	49.75	50.0	100.0	0.008	3.286
16	2022-08-10	19:03:28	1	366.3	0.0	49.75	50.0	100.0	0.008	3.286

<< 47/598 >>

Stop Read All
Save DELETE ALL

7.3.6. History Events

Select Events, and click the READ ALL button. The HVESS-Monitor will start the task of reading history events, and create the reading process with the slave computer. After receiving the response, the received history events will be analysed and displayed in the list, and the latest time will be displayed above the list. Click the SAVE button to save the read history events to the user-selected path for offline analysis.

The screenshot shows the SUN SYNK HVESS-Monitor interface. The top navigation bar includes a search icon, home icon, and lock icon. The status bar shows 'Group 01', 'Life: 161', 'More Info.', 'PROTECTION' (red dot), '2023', 'ALARM' (yellow dot), and '00:10'. The sidebar on the left has sections for GENERAL, HISTORY, SETTINGS, and PCS. The main content area is titled 'History Events' and contains a table with the following data:

	Date	Time	Name	Flag	Value	CellPos
1	2022-09-15	10:17:15	BmuCommError	Active		249
2	2022-09-15	10:17:14	EncodeFinish			249
3	2022-09-15	10:17:13	BmuNumConfigError			0
4	2022-09-15	10:17:09	EncodeFinish			0
5	2022-09-15	10:10:21	PowerOff			251
6	2022-09-15	10:04:52	BmuCommError	Active		0
7	2022-09-15	10:04:50	BmuNumConfigError			0
8	2022-09-14	15:29:46	BmuCommError	Active		249
9	2022-09-14	15:29:45	EncodeFinish			249
10	2022-09-14	15:29:43	BmuNumConfigError			0
11	2022-09-14	15:29:39	EncodeFinish			0
12	2022-09-14	08:22:22	PowerOff			0
13	2165-165-165	25:165:165	PowerOff			0
14	2022-08-11	16:24:14	CurrModuleFault	Active		251
15	2022-08-11	16:24:14	PowerOff			248
16	2022-08-11	16:24:14	ChgRelayAction	OFF		248

Below the table, there are navigation arrows, a '75/75' indicator, and buttons for 'Stop', 'Save', 'Read All', and 'DELETE ALL'. The sidebar on the left has sections for GENERAL, HISTORY, SETTINGS, and PCS. The top right shows system status indicators for PROTECTION and ALARM.

7.3.7. Real-Time Data Storage of the HVESS-Monitor

Click the RECORDING button to start the real-time saving of operational data, and click the STOP button to stop the real-time saving. Click the SAVE button to save the recorded real-time operational data to the user-selected path for offline analysis. Click the CLEAR button to clear the displayed data in the list.

The screenshot shows the SUN SYNK HVESS-Monitor interface. The sidebar on the left contains the following sections:

- GENERAL**
 - Base Info
 - Parallel Info
- HISTORY**
 - Statistics
 - History Data
- SETTINGS**
 - BMS Parameter
 - BMU Parameter
 - Firmware
 - Manufacture
- PCS**
 - Info

At the top of the main area, there is a search icon, home icon, and lock icon. The status bar shows "Group 01", "Life: 161", and "More info". On the right, there are indicators for "PROTECTION" (red circle) and "ALARM" (yellow circle), along with the date "2023" and time "00:10".

The "Real Time Recording" section is active, showing a table with the following data:

	Date	Time	SlaveNo	State	SubState	SumVolt(V)	Curr(A)	BatVolt	MotorVolt	ChgVolt
1	2022-09-15	10:38:33	1	0	249	365.1	0.0	365.1	547.4	0.0
2	2022-09-15	10:38:35	1	0	249	365.1	0.0	365.1	547.4	0.0
3	2022-09-15	10:38:37	1	0	249	365.1	0.0	365.1	547.4	0.0

Below the table, there are navigation arrows (left and right). At the bottom of the main area, there are four buttons: "Recording" (highlighted), "Stop", "Clear", and "Save".

7.3.8. Parameter

The parameter interface includes BMS parameters and BMU parameters. The operation method is the same. Click the READ ALL button to display such data as ALARM, ALM Recover, ALM Delay, PROTECTION, PROT Recover and PROT Delay on corresponding windows, these are factory default values. When the reading is complete, the corresponding windows will become blue.

The screenshot shows the SUN SYNK parameter interface. The left sidebar contains navigation menus for GENERAL, HISTORY, and SETTINGS. The main area displays four parameter tables: Cell Over Charge, System Over Charge, Cell Over Discharge, and System Over Discharge. Each table lists parameters like Alarm, ALM Recover, ALM Delay, Protection, PROT Recover, and PROT Delay with their units and values. Buttons for Read and Write are provided for each parameter. At the bottom right, there are buttons for Read All, Write All, and Recover Default. The top right shows status indicators for PROTECTION (red) and ALARM (yellow) with a timestamp of 2023 00:10.

The screenshot shows the SUN SYNK parameter interface for BMU parameters. The left sidebar is the same as in the previous screenshot. The main area displays two rows of parameters: Battery Code and Serial Number. Each row has a text input field, a BMU dropdown menu, and buttons for Read, Write, Read All, and Write All. The Read and Write buttons are highlighted in red. At the bottom, a legend indicates: Green: operation succeeded, Red: operation failed, Yellow: the data read out is inconsistent. The top right shows status indicators for PROTECTION (red) and ALARM (yellow) with a timestamp of 2023 00:10.

7.3.9. INTER-CAN Firmware Upgrade

Make a selection in the red box of the BMS CAN-BUS upgrade and BMU CAN-BUS upgrade interface. Click the Browser button, select the configuration file to be upgraded from the computer, or drag the BIN file to be upgraded to the upgrade interface. The HVES-Monitor will read and analyse the data in the file and display it on the corresponding input interface. Click Start to start upgrading.

In the case of parallel device operation, when the device address is filled in with 1, the HVES-Monitor will start with No.1 BMS to upgrade BMS and BMU in the entire system one by one. Regardless of whether a BMS upgrade succeeds or not, it will continue to upgrade BMS at the next address. When the device address is filled with a figure other than 1 (for example, 2), the HVES-Monitor will only upgrade a single BMS whose address matches the input. The single BMU upgrade operation is similar. After the upgrade, OK will be displayed.

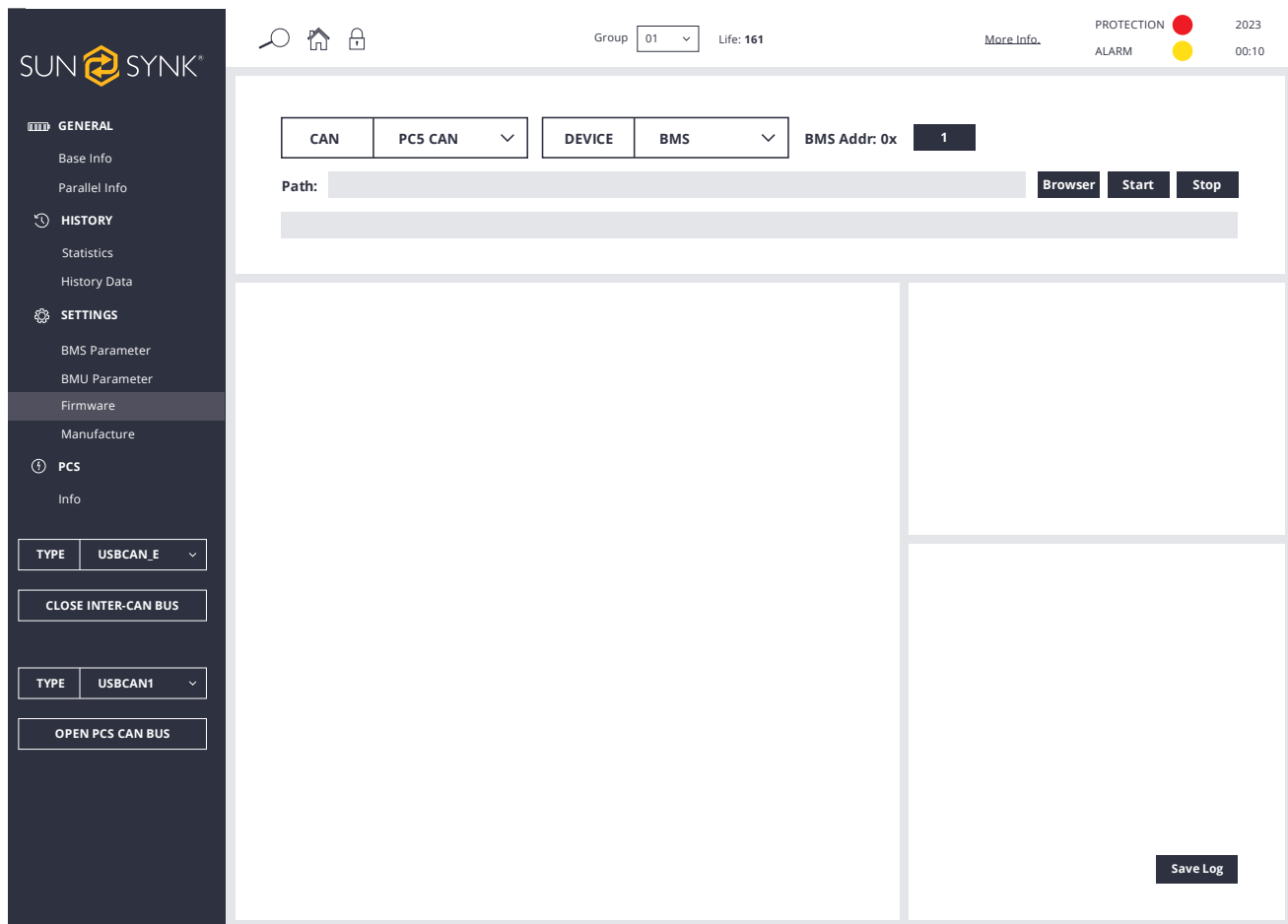

7.3.10. Manufacture

Click the Read button to read the product serial number and other related information. The default operational or working mode is Factory Mode. To display more details, change to Debug Mode and click the Set button. The number of read/set successes/failures is displayed in the lower right corner. Restart to automatically return to Factory Mode.

SUN SYNK

Group 01 Life: 161

PROTECTION 2023
ALARM 00:10

More Info.

Product Serial Code

Software Version	HVCUB1622804N1T	Read
Hardware Version	HVCU02	Read
BMS SN	PW0055	Read
Time Calibration	NG	Read
History Energy	Clear	
Operation	Debug Mode	<input type="checkbox"/> To All Set
Power On Count	11957	Read Clear
Battery Type	EVE 100Ah	Read <input type="checkbox"/> To All Set
Relay Adhesion	Clear	

STATISTICS		
PASS	4	NG

GENERAL

Base Info

Parallel Info

HISTORY

Statistics

History Data

SETTINGS

BMS Parameter

BMU Parameter

Firmware

Manufacture

PCS

Info

TYPE USBCAN_E

CLOSE INTER-CAN BUS

TYPE USBCAN1

OPEN PCS CAN BUS

7.3.11. Cell Types

SUN SYNK

Group 01 Life: 161

PROTECTION 2023
ALARM 00:10

More Info.

Product Serial Code

Software Version	HVCUB1622804N1T	Read
Hardware Version	HVCU02	Read
BMS SN	PW0055	Read
Time Calibration	NG	Read
History Energy	Clear	
Operation	Debug Mode	<input type="checkbox"/> To All Set
Power On Count	11957	Read Clear
Battery Type	EVE 100Ah	Read <input type="checkbox"/> To All Set
Relay Adhesion	Clear	

STATISTICS		
PASS	4	NG

GENERAL

Base Info

Parallel Info

HISTORY

Statistics

History Data

SETTINGS

BMS Parameter

BMU Parameter

Firmware

Manufacture

PCS

Info

TYPE USBCAN_E

CLOSE INTER-CAN BUS

TYPE USBCAN1

OPEN PCS CAN BUS

7.3.12. Inverter Information

When the INVERTER CAN communication is connected externally, click **OPEN PCS CAN BUS**. This interface will display the information related to the communication with the inverter.

The screenshot displays the SUN SYNK web interface for Inverter Information. The interface includes a sidebar with navigation menus (GENERAL, HISTORY, SETTINGS, PCS), a top status bar with protection and alarm indicators, and a main data table with columns for Summary and 1. The table lists various parameters such as PCS Time, Charge Voltage, SOC, SOH, Current, Temperature, Max/Min Cell Voltage, Software/Hardware Versions, and System Status.

	Summary		1
PCS Time		Parallel	
Charge Voltage(V)		Positive	
Chg Cur Limit with Power Sys(A)		Precharge	
Discharge Voltage Limit(V)		Discharge	
SOC(%)		Charge	
SOH(%)		Heater Positive	
Voltage(V)		Heater Negative	
Current(A)		BMU	
Temperature(°C)		Voltage(V)	
Max Cell Voltage(V)		Current(A)	
Min Cell Voltage(V)		SOC(%)	
Max Cell Temperature(°C)		SOH(%)	
Min Cell Temperature(°C)		Max Cell Voltage(V)	
Software Version		Min Cell Voltage(V)	
Hardware Version		Max Cell Temperature(°C)	
Online Module Count		Min Cell Temperature(°C)	
Charge Disable Count		Insulation(kΩ)	
Discharge Disable Count		Heater Temperature(°C)	
Communication Error Count		System Status	
Acting Module Count		System Error Level	
Max Charge Current(A)		Cycle Count	
Max Discharge Current(A)		Software Version	
Manufacturer Name		Serial No.	
Module ID		Balance(01-08)	

7.3.13. PCS CAN Firmware Upgrade

Click the Browser button, select the configuration file you need to upgrade from the computer, or drag and drop the BIN file you need to upgrade to the upgrade interface. The HVESS-Monitor will read and analyse the data in the file and display it on the corresponding input interface. Click the Start button to start upgrading.

In the case of parallel device operation, when the device address is filled in with 1, the HVESS-Monitor will upgrade the BMS and BMU in the entire system one by one, starting from No.1 BMS. Regardless of whether a BMS upgrade succeeds or not, it will continue to upgrade BMS at the next address. When the device address is filled in with a figure other than 1 (for example, 2), the HVESS-Monitor will only upgrade a single BMS whose address matches the input. The single BMU upgrade operation is similar. After the upgrade, an OK message will be displayed.

The screenshot shows the SUN SYNK HVESS-Monitor interface. On the left is a dark sidebar with the SUN SYNK logo and a menu with categories: GENERAL (Base Info, Parallel Info), HISTORY (Statistics, History Data), SETTINGS (BMS Parameter, BMU Parameter, Firmware, Manufacture), and PCS (Info). Below the menu are two sections for bus control: one for USBCAN_E with a 'CLOSE INTER-CAN BUS' button, and one for USBCAN1 with an 'OPEN PCS CAN BUS' button. The main interface has a top header with search, home, and lock icons, a 'Group' dropdown set to '01', 'Life: 161', a 'More Info' link, and status indicators for 'PROTECTION' (red circle) and 'ALARM' (yellow circle) with a timestamp '2023 00:10'. The central area contains a configuration section with 'CAN' and 'PCS CAN' dropdowns, 'DEVICE' and 'BMS' dropdowns, and a 'BMS Addr: 0x' field with the value '1'. Below this is a 'Path:' input field and three buttons: 'Browser', 'Start', and 'Stop'. A 'Save Log' button is located in the bottom right corner of the main area.

8. FAULT DESCRIPTION

Different types of faults are below:

Fault types	Trigger conditions
Charge over-current alarm	Exceeding the parameter set value and set time (More than 105A, 2s; more than 125A, 5s; more than 140A, 2s; lower than 5°C, set value*0.5)
Charge over-current protection	
Discharge over-current alarm	
Discharge over-current protection	
Charge overtemperature alarm	Exceeding the parameter set value and set time (>45°C, 2s)
Charge overtemperature protection	Exceeding the parameter set value and set time (>50°C, 2s)
Discharge overtemperature alarm	Exceeding the parameter set value and set time (>50°C, 2s)
Discharge overtemperature protection	Exceeding the parameter set value and set time (>55°C, 2s)
Charge under temperature alarm	Exceeding the parameter set value and set time (<5°C, 2s)
Charge under temperature protection	Exceeding the parameter set value and set time (<0°C, 2s)
Discharge under temperature alarm	Exceeding the parameter set value and set time (<-10°C, 2s)
Discharge under temperature protection	Exceeding the parameter set value and set time (<-20°C, 2s)
Excessive differential voltage alarm	Exceeding the parameter set value and set time (>500mv, 2s)
Excessive differential voltage protection	Exceeding the parameter set value and set time (>800mv, 2s)
Excessive differential temperature alarm	Exceeding the parameter set value and set time (>10°C, 2s)
Excessive differential temperature protection	Exceeding the parameter set value and set time (>15°C, 2s)
Cell overvoltage alarm	To maintain consistency, cut off the charging immediately when the full charge calibration rated voltage of 3.6V is reached. When the voltage drops to 3.35V, restart it with the turned off red light indicator All protective red light indicators are always on!
Cell overvoltage protection	
Cell undervoltage alarm	
Cell undervoltage protection	
Pre-charge resistor overtemperature alarm	Exceeding the parameter set value and set time (>55°C, 2s)
Pre-charge resistor overtemperature protection	Exceeding the parameter set value and set time (>65°C, 2s)
Insulation level 1	Exceeding the parameter set value and set time
Insulation level 2	Exceeding the parameter set value and set time
Heating film overtemperature alarm	Exceeding the parameter set value and set time (>75°C, 2s)
Heating film overtemperature protection	Exceeding the parameter set value and set time (>80°C, 2s)

Fault types	Trigger conditions
BMS connector overtemperature alarm	Exceeding the parameter set value and set time
BMS connector overtemperature protection	Exceeding the parameter set value and set time
BMU connector overtemperature alarm	Exceeding the parameter set value and set time
BMU connector overtemperature protection	Exceeding the parameter set value and set time
Power loop overtemperature alarm	Exceeding the parameter set value and set time
Power loop overtemperature protection	Exceeding the parameter set value and set time
SOC too low	Exceeding the parameter set value and set time
Total voltage too high alarm	Exceeding the parameter set value and set time
Total voltage too high protection	Exceeding the parameter set value and set time
Total voltage too low alarm	Exceeding the parameter set value and set time
Total voltage too low protection	Exceeding the parameter set value and set time
Discharge relay adhesion	Relay feedback information state adhesion
Charge relay adhesion	Relay feedback information state adhesion
Heating relay adhesion	High voltage is detected after disconnecting the heating relay
Limit protection	Exceeding the parameter set value and set time
Abnormal power supply voltage	Exceeding the parameter set value and set time
Master positive relay adhesion	Relay feedback information state adhesion
Fuse Blown	No high voltage is detected after the loop relay is closed
Repeated BMU address fault	BMU with the same number
INTER-CAN BUS communication failure	Loss of communication between BMS
PCS-CAN BUS communication failure	The heartbeat message of the inverter is not received for a long time
RS485 communication failure	Inverter RS485 access is not received for a long time
Abnormal RS485 communication	C
External total voltage acquisition fault	/
Internal total voltage acquisition fault	The difference between the acquired internal total voltage and the accumulated internal total voltage exceeding the set value
SCHG total voltage acquisition fault	/
Cell voltage acquisition fault	The cell voltage acquired is 0
Temperature acquisition fault	The temperature acquired is -40 °C
Current acquisition fault	/
Current module fault	Abnormal Hall current/reference voltage
EEPROM storage failure	EEPROM write failure during self-set
RTC clock fault	The external RTC failed to enable the charging function
Pre-charge failure	Pre-charge timeout
Charging voltage too low	The minimum cell voltage is lower than the set value
BMU lost	BMU message nor received for a long time
Abnormal number of BMU	The number of BMU address is different from the number of set parameters

9. FAULT TYPES SUMMARY IN SCREEN AND HVESS-MONITOR

Abbreviation	Screen protection event description	HVESS-Monitor protection event description	HVESS-Monitor alarm event description
OT	BMS southward connector overtemperature	BMU connector overtemperature protection	BMU connector overtemperature alarm
	BMS northward connector overtemperature	BMS connector overtemperature protection	BMS connector overtemperature alarm
	Pre-charge resistor overtemperature level-2 alarm	Pre-charge resistor overtemperature protection	Pre-charge resistor overtemperature alarm
	Heating film overtemperature level-2 alarm	Heating film overtemperature protection	Heating film overtemperature alarm
	Charge overtemperature level-2 alarm	Charge overtemperature protection	Charge overtemperature alarm
	Discharge overtemperature level-2 alarm	Discharge overtemperature protection	Discharge overtemperature alarm
	/	Power loop overtemperature protection	Power loop overtemperature alarm
UT	Charge under temperature level-2 alarm	Charge under temperature protection	Charge under temperature alarm
	Discharge under temperature level-2 alarm	Discharge under temperature protection	Discharge under temperature alarm
OC	Charge overcurrent level-2 alarm	Charge overcurrent protection	Charge overcurrent alarm
	Discharge overcurrent level-2 alarm	Discharge overcurrent protection	Discharge overcurrent alarm
DV	Excessive differential voltage level-2 alarm	Excessive differential voltage protection	Excessive differential voltage alarm
DT	Excessive differential temperature level-2 alarm	Excessive differential temperature protection	Excessive differential temperature alarm
OV	Total charge voltage too high	Total charge voltage too high protection	Total charge voltage too high alarm
	Cell overvoltage level-2 alarm	Cell overvoltage protection	Cell overvoltage alarm
UV	Charge voltage level-2 too low	Charge voltage too low protection	/
	Total discharge voltage too low	Total discharge voltage too low protection	Total discharge voltage too low alarm
	Cell undervoltage level-2 alarm	Cell undervoltage protection	Cell undervoltage alarm

Abbreviation	Screen protection event description	HVESS-Monitor protection event description	HVESS-Monitor alarm event description
OF	Abnormal number of BMU	Abnormal number of BMU	/
	BMU lost	BMU lost	/
	RTC clock fault	RTC clock fault	/
	Current module fault	Current module fault	/
	SCHG total voltage acquisition fault	SCHG total voltage acquisition fault	/
	Abnormal RS485 communication	Abnormal RS485 communication	/
	RS485 communication failure	RS485 communication failure	/
	PCS-CAN BUS communication failure	PCS-CAN BUS communication failure	/
	Repeated BMS address fault	Repeated BMS address fault	/
	Repeated BMU address fault	Repeated BMU address fault	/
	Abnormal power supply voltage	Abnormal power supply voltage	/
	Heating relay adhesion	Heating relay adhesion	/
	SOC too low	SOC too low	/
	SOC too high	SOC too high protection	/
	Fuse Blown	Fuse Blown	/
	Charge relay adhesion	Charge relay adhesion	/
	Discharge relay adhesion	Discharge relay adhesion	/
	Master positive relay adhesion	Master positive relay adhesion	/
	Temperature acquisition failure	Temperature acquisition failure	/
	Cell voltage acquisition fault	Cell voltage acquisition fault	/
	Inter communication failure	INTER-CAN BUS communication failure	/
	Pre-charge failure	Pre-charge failure	/
	Insulation level-2 alarm	Insulation level-2	Insulation level-1
	External total voltage acquisition fault	External total voltage acquisition fault	/
	Internal total voltage acquisition fault	Internal total voltage acquisition fault	/
	Current acquisition fault	Current acquisition fault	/
	Limit protection	Limit protection	/
EEPROM failure	EEPROM storage failure	/	
ISO EEPROM failure	Insulation level-2	Insulation level-2	/

10. MAINTENANCE AND UPGRADE



CAUTION

- Improper decommissioning may cause damage to the equipment and/or battery inverter.
- Before maintenance, ensure that High Voltage Series Battery is decommissioned according to relevant provisions.

PLEASE NOTE

All maintenance work shall comply with local applicable regulations and standards. The USB disk port of High Voltage Series Battery has the functions of upgrading firmware and recording battery data, which can be used as an auxiliary tool.

10.1. Maintenance of High Voltage Series Battery

To ensure safe operation, all plug connections must be checked. If necessary, relevant operators shall press them back into place at least once a year.

The following inspection or maintenance must be carried out once a year:

- General visual inspection
- Check all tightened electrical connections. Check the tightening torque according to the values in the following table. Loose connections must be retightened to the specified torque.

Connection mode	Tightening torque
High-voltage control box grounding	4.5Nm
Fixing the lug of the high-voltage control box	1.2Nm
Fixing the lug of the battery module	1.2Nm

- Using the monitoring software, check whether the SoC, SOH, battery voltage and temperature of the battery module are abnormal.
- Shut down and restart High Voltage Series Battery once a year.

PLEASE NOTE

- If the system is installed in a polluted environment, maintenance and cleaning must be carried out at short intervals.
- Clean the battery rack with a dry-cleaning cloth. Ensure that no moisture comes into contact with the battery connections. Do not use solvents.

10.2. USB's Upgrade Step

1. USB type: USB2.0, FAT32;
2. Create the upgrade folder according to the directory;
3. Place the upgrade file provided by the supplier in the upgrade folder;
4. Turn on the battery, and insert the USB flash disk after the blue indicator is on;
5. After the blue light indicator flashes and turns off, pull out the USB flash disk to complete the upgrade. Do not turn off the battery during the process.
6. After the blue light indicator of the battery lights up again, check the version number through the screen or app and verify the upgrade result.

11. BATTERY MODULE STORAGE

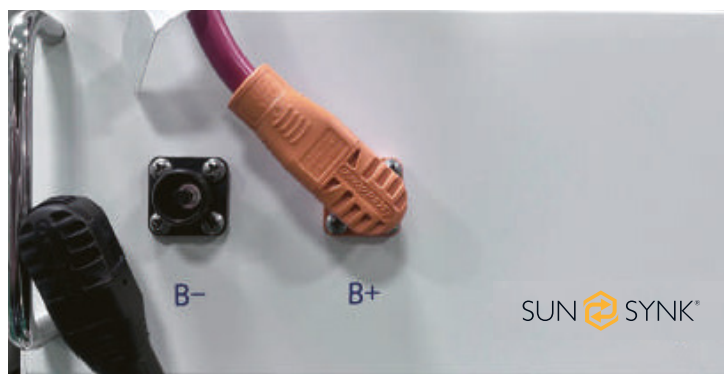

1. To ensure the battery service life, the storage temperature shall be kept between 0°C~35°C. The battery shall be cycled at least once every 6 months.
2. To minimize self-discharge in a long storage period, disconnect the BATTERY connection (1/2) of the high-voltage control box of the DC connecting cable. This will interrupt the use of the 12 V power supply installed in the high-voltage control box and prevent the battery from self-discharging.

12. DISPOSAL

For details related to the disposal of battery modules, please contact us. Tel: +852 2884 4318 / Email: [www.support@sunsynk.com](mailto:support@sunsynk.com) / sales@sunsynk.com For more information, please visit www.sunsynk.com.

Observe applicable regulations on waste battery disposal. Immediately stop the use of damaged batteries. Please contact your installer or sales partner before disposal. Ensure that the battery is not exposed to moisture or direct sunlight.



CAUTION

1. Do not dispose of batteries and rechargeable batteries as domestic waste! You are legally obliged to return used batteries and rechargeable batteries.
2. Waste batteries may contain pollutants that can damage the environment or your health if improperly stored or handled.
3. Batteries also contain iron, lithium and other important raw materials, which can be recycled.

For more information, please visit www.sunsynk.com. Do not dispose of batteries as household waste!



APPENDIX

Circuit Diagram for On Grid System with 12V Supply

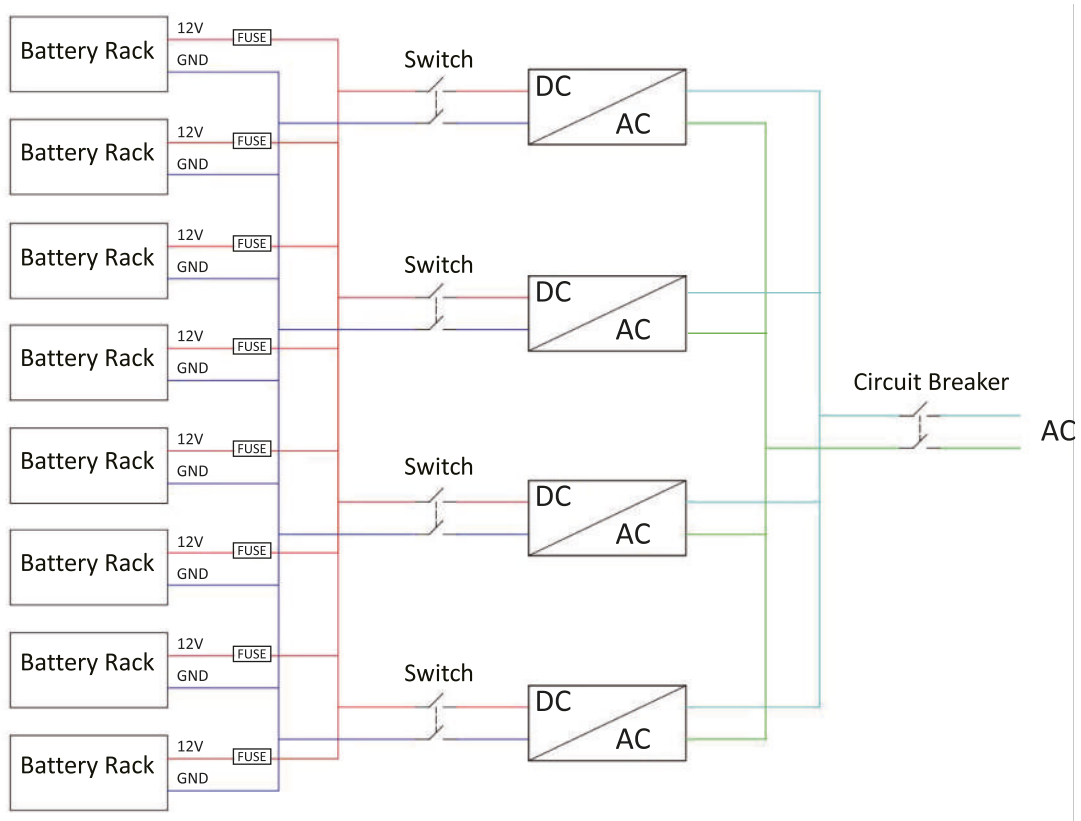



CONTACT US

Email us: sales@sunsynk.com **Call us UK:** +44 151 832 4300

VAT Number: 175669460

UK Address: Sunsynk, 17 Turnstone Business Park,
Mulberry Avenue, Widnes, Cheshire, WA8 0WN.

GlobalTech Ltd

ena
energy networks
association

Approved

SGS

UK CA CE

Powered by
SUN SYNK