

Operating Manual
SUNNY TRIPOWER CORE1

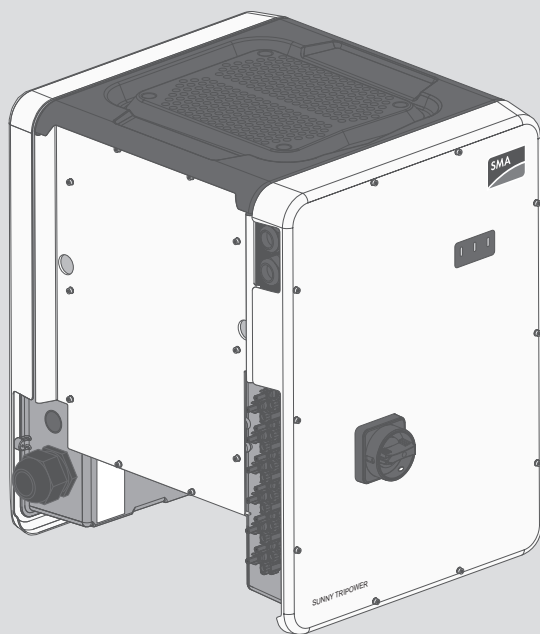

Table of Contents

1	Information on this Document	6
1.1	Validity	6
1.2	Structure	6
1.3	Target Group	6
1.4	Symbols	6
1.5	Additional Information.....	7
1.6	Nomenclature	7
1.7	Typographies	8
2	Safety	9
2.1	Intended Use.....	9
2.2	Safety Information	9
3	Scope of Delivery	12
4	Product Description	13
4.1	Sunny Tripower	13
4.2	Interfaces and Functions.....	15
5	Mounting.....	18
5.1	Requirements for Mounting.....	18
5.2	Mounting the Inverter	21
6	Electrical Connection	24
6.1	Safety during Electrical Connection	24
6.2	Overview of the Connection Area.....	25
6.3	AC Connection	25
6.3.1	Requirements for the AC Connection	25
6.3.2	Connecting the Inverter to the Utility Grid	27
6.4	DC Connection	28
6.4.1	Requirements for the DC Connection	28
6.4.2	Assembling the DC Connectors	29
6.4.3	Connecting the PV Array.....	31
6.4.4	Disassembling the DC Connectors	33
6.5	Connecting the Multifunction Relay.....	35

6.5.1	Procedure for connecting the multifunction relay	35
6.5.2	Operating Modes of the Multifunction Relay	35
6.5.3	Connection Options	35
6.5.4	Connection to the Multifunction Relay	39
6.6	Connecting the Network Cables	41
7	Commissioning	43
7.1	Commissioning Procedure.....	43
7.2	Commissioning the Inverter	43
7.3	Starting the Self-Test (For Italy Only).....	44
7.4	Selecting a configuration option.....	45
8	Using the Inverter User Interface.....	49
8.1	Establishing a connection to the user interface.....	49
8.1.1	Establishing a direct connection via WLAN.....	49
8.1.2	Establishing a Connection via Ethernet in the local network	51
8.2	Logging In and Out of the User Interface	52
8.3	Start Page Design of the User Interface	53
8.4	Changing the Password	57
9	Configuration of the Inverter.....	58
9.1	Changing Operating Parameters	58
9.2	Starting the Installation Assistant	59
9.3	Configuring the Country Data Set.....	60
9.4	Changing the Operating Mode of the Multifunction Relay.....	60
9.5	Configuring the Modbus Function	61
9.6	Setting the Tripping Threshold of the Residual-Current Device	62
9.7	Configuring Feed-In Management	62
9.8	Setting SMA OptiTrac Global Peak.....	62
9.9	Activating the Receipt of Control Signals (Only for Italy)	63
9.10	Activating String-Failure Detection.....	63
9.11	Saving the Configuration in a File	64
9.12	Adopting a Configuration from a File	64
9.13	Switching the Dynamic Power Display Off	65
9.14	Switching WLAN On and Off	65

9.15	Activate WPS Function	66
10	Disconnecting the Inverter from Voltage Sources	67
11	Cleaning the Inverter	69
12	Troubleshooting.....	70
12.1	Event Messages	70
12.2	LED Signals	85
12.3	Forgotten Password.....	86
12.4	Checking the PV System for Ground Faults	87
12.5	Updating the Firmware	90
13	Decommissioning the Inverter.....	92
14	Technical Data	96
15	Accessories	100
16	Contact	101
17	EU Declaration of Conformity	104

Legal Provisions

The information contained in these documents is property of SMA Solar Technology AG. Any publication, whether in whole or in part, requires prior written approval by SMA Solar Technology AG. Internal reproduction used solely for the purpose of product evaluation or other proper use is allowed and does not require prior approval.

SMA Warranty

You can download the current warranty conditions from the Internet at www.SMA-Solar.com.

Software licenses

The licenses for the used software modules can be called up on the user interface of the product.

Trademarks

All trademarks are recognized, even if not explicitly identified as such. Missing designations do not mean that a product or brand is not a registered trademark.

Modbus[®] is a registered trademark of Schneider Electric and is licensed by the Modbus Organization, Inc.

QR Code is a registered trademark of DENSO WAVE INCORPORATED.

Phillips[®] and Pozidriv[®] are registered trademarks of Phillips Screw Company.

Torx[®] is a registered trademark of Acument Global Technologies, Inc.

SMA Solar Technology AG

Sonnenallee 1

34266 Niestetal

Germany

Tel. +49 561 9522-0

Fax +49 561 9522-100

www.SMA.de

Email: info@SMA.de

Status: 6/2/2017

Copyright © 2017 SMA Solar Technology AG. All rights reserved.

1 Information on this Document

1.1 Validity

This document is valid for device type "STP 50-40" (Sunny Tripower CORE1).

1.2 Structure

This document describes the mounting, installation, commissioning, configuration, operation, troubleshooting and decommissioning of the product as well as the operation of the product user interface.





You will find the latest version of this document and further information on the product in PDF format at www.SMA-Solar.com.

1.3 Target Group

This document is intended for qualified persons and end users. Only qualified persons are allowed to perform the activities marked in this document with a warning symbol and the caption "Qualified person". Tasks that do not require any particular qualification are not marked and can also be performed by end users. Qualified persons must have the following skills:

- Knowledge of how an inverter works and is operated
- Training in how to deal with the dangers and risks associated with installing and using electrical devices and installations
- Training in the installation and commissioning of electrical devices and installations
- Knowledge of the applicable standards and directives
- Knowledge of and compliance with this document and all safety information

1.4 Symbols

Symbol	Explanation
 DANGER	Indicates a hazardous situation which, if not avoided, will result in death or serious injury
 WARNING	Indicates a hazardous situation which, if not avoided, can result in death or serious injury
 CAUTION	Indicates a hazardous situation which, if not avoided, can result in minor or moderate injury
NOTICE	Indicates a situation which, if not avoided, can result in property damage
 QUALIFIED PERSON	Sections describing activities to be performed by qualified persons only
	Information that is important for a specific topic or goal, but is not safety-relevant

Symbol	Explanation
□	Indicates a requirement for meeting a specific goal
☑	Desired result
✘	A problem that might occur

1.5 Additional Information

Links to additional information can be found at www.SMA-Solar.com:

Document title	Document type
"Parameters and Measured Values" Overview of All Inverter Operating Parameters and Their Configuration Options	Technical Information
"Webconnect Systems in Sunny Portal" Registration in Sunny Portal and setting or changing operating parameters of the inverter	User Manual
"SMA Modbus® Interface" Information on the commissioning and configuration of the SMA Modbus interface	Technical Information
"SunSpec® Modbus® Interface" Information on the commissioning and configuration of the SunSpec Modbus interface	Technical Information
"Efficiency and Derating" Efficiency and Derating Behavior of the Sunny Boy, Sunny Tripower and Sunny Mini Central Inverters	Technical Information

1.6 Nomenclature

Complete designation	Designation in this document
Sunny Tripower CORE1	Inverter, product

1.7 Typographies

Typography	Use	Example
bold	<ul style="list-style-type: none"> • Terminals • Slots • Parameters • Elements on the user interface • Elements to be selected • Elements to be entered 	<ul style="list-style-type: none"> • The value can be found in the field Energy. • Select Settings. • Enter 10 in the field Minutes.
>	<ul style="list-style-type: none"> • Connects several elements to be selected 	<ul style="list-style-type: none"> • Select Settings > Date.
[Button]	<ul style="list-style-type: none"> • Button to be selected or pressed 	<ul style="list-style-type: none"> • Select [Next].

2 Safety

2.1 Intended Use

The Sunny Tripower is a transformerless PV inverter, with 6 MPP trackers, that converts the direct current of the PV array to grid-compliant, three-phase current and feeds it into the utility grid.

The product is suitable for indoor and outdoor use.

The product must only be operated with PV arrays of protection class II in accordance with IEC 61730, application class A. The PV modules must be compatible with this product.

The product must only be operated with PV modules and cables that have been recommended and sold by the distributor. Do not connect any energy sources other than PV modules to the product.

The product is not equipped with a transformer and therefore has no galvanic isolation. The product must not be operated with PV modules whose outputs are grounded. This can cause the product to be destroyed. The product may be operated with PV modules whose frame is grounded.

PV modules with a high capacity to ground must only be used if their coupling capacity does not exceed 12.6 μF (for information on how to calculate the coupling capacity, see the Technical Information "Leading Leakage Currents" at www.SMA-Solar.com).

All components must remain within their permitted operating ranges at all times.

The product must only be used in countries for which it is approved or released by SMA Solar Technology AG and the grid operator.

The product is also approved for the Australian market and may be used in Australia. If DRM support is specified, the inverter may only be used in conjunction with a Demand Response Enabling Device (DRED). This ensures that the inverter implements the commands from the grid operator for active power limitation at all times. The inverter and the Demand Response Enabling Device (DRED) must be connected in the same network and the inverter Modbus interface must be activated and the TCP server set.

Use this product only in accordance with the information provided in the enclosed documentation and with the locally applicable standards and directives. Any other application may cause personal injury or property damage.

Alterations to the product, e.g. changes or modifications, are only permitted with the express written permission of SMA Solar Technology AG. Unauthorized alterations will void guarantee and warranty claims and in most cases terminate the operating license. SMA Solar Technology AG shall not be held liable for any damage caused by such changes.

Any use of the product other than that described in the Intended Use section does not qualify as the intended use.

The enclosed documentation is an integral part of this product. Keep the documentation in a convenient place for future reference and observe all instructions contained therein.

The type label must remain permanently attached to the product.

2.2 Safety Information

This section contains safety information that must be observed at all times when working on or with the product.

To prevent personal injury and property damage and to ensure long-term operation of the product, read this section carefully and observe all safety information at all times.

DANGER

Danger to life due to high voltages of the PV array

When exposed to sunlight, the PV array generates dangerous DC voltage, which is present in the DC conductors and the live components of the inverter. Touching the DC conductors or the live components can lead to lethal electric shocks. If you disconnect the DC connectors from the inverter under load, an electric arc may occur leading to electric shock and burns.

- Do not touch non-insulated cable ends.
- Do not touch the DC conductors.
- Do not touch any live components of the inverter.
- Have the inverter mounted, installed and commissioned only by qualified persons with the appropriate skills.
- If an error occurs, have it rectified by qualified persons only.
- Prior to performing any work on the inverter, disconnect it from all voltage sources as described in this document.

DANGER

Danger to life due to electric shock

Touching an ungrounded PV module or array frame can cause a lethal electric shock.

- Connect and ground the frame of the PV modules, the array frame and the electrically conductive surfaces so that there is continuous conduction. Observe the applicable local regulations.

CAUTION

Risk of burns due to hot enclosure parts

The enclosure and the enclosure lid may get hot during operation. The DC load-break switch can not become hot.

- Do not touch hot surfaces.
- Wait until the inverter has cooled down before touching the enclosure or enclosure lid.

NOTICE**Damage to seals on the enclosure lids in subfreezing conditions**

If you open the enclosure lids when temperatures are below freezing, the enclosure seals can be damaged. This can lead to moisture entering the inverter.

- Only open the enclosure lids if the ambient temperature is not below -5°C
- If a layer of ice has formed on the seal of the lid when temperatures are below freezing, remove it prior to opening the enclosure lids (e.g. by melting the ice with warm air). Observe the applicable safety regulations.

NOTICE**Damage to the type label due to the use of cleaning agents**

- If the inverter is dirty, clean the enclosure, the enclosure lid, the type label and the LEDs with a damp cloth and clear water only.

3 Scope of Delivery

Check the scope of delivery for completeness and any externally visible damage. Contact your distributor if the scope of delivery is incomplete or damaged.

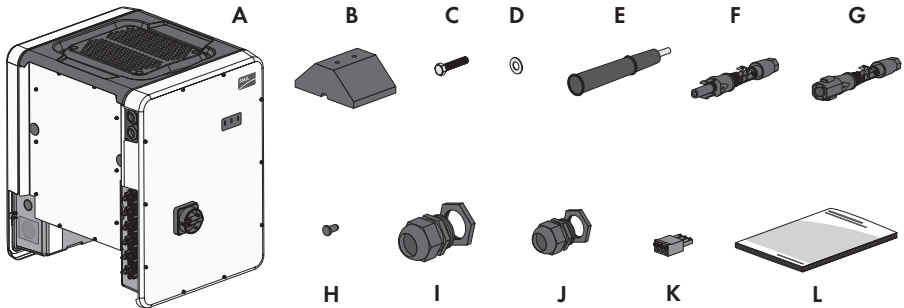

Figure 1: Components included in the scope of delivery

Position	Quantity	Designation
A	1	Inverter
B	4	Foot
C	8	Hexagon bolt M8x40
D	8	Washer
E	4	Carrying handle
F	12	Positive DC connector
G	12	Negative DC connector
H	24	Sealing plug for DC connectors
I	1	Cable gland M63 with counter nut
J	1	M32 cable gland with one-hole cable support sleeve and counter nut
K	1	3-pole connecting terminal plate
L	1	Quick Reference Guide

4 Product Description

4.1 Sunny Tripower

The Sunny Tripower is a transformerless PV inverter, with 6 MPP trackers, that converts the direct current of the PV array to grid-compliant, three-phase current and feeds it into the utility grid.

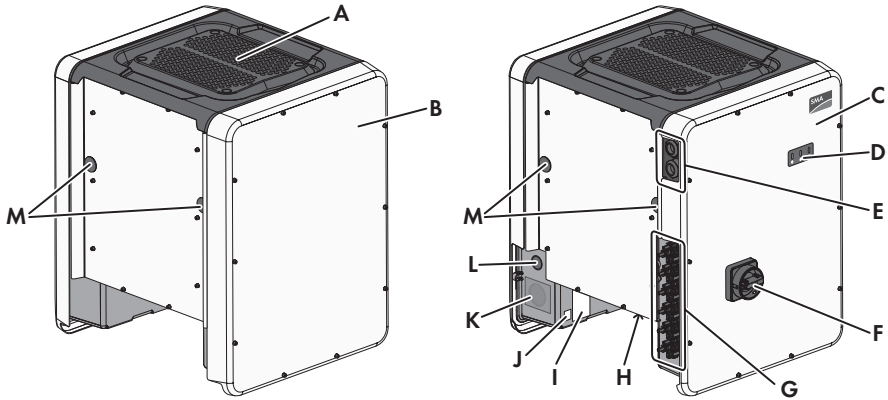

















Figure 2: Design of the Sunny Tripower

Position	Designation
A	Cover
B	AC Connection Unit
C	DC Connection Unit
D	LEDs The LEDs indicate the operating state of the inverter.
E	Cable glands for data cables
F	DC load-break switch
G	DC connector
H	Fan bracket with three fans
I	Type label The type label uniquely identifies the inverter. The type label must remain permanently attached to the product. You will find the following information on the type label: <ul style="list-style-type: none"> • Device type (Model) • Serial number (Serial No.) • Date of manufacture • Device-specific characteristics

Position	Designation
J	Additional label with details for registration in Sunny Portal and WLAN password: <ul style="list-style-type: none"> • Identification key (PIC) for registration in Sunny Portal • Registration ID (RID) for registration in Sunny Portal • WLAN password (WPA2-PSK) for the direct connection to the user interface of the inverter via WLAN
K	Enclosure opening for AC connection
L	Enclosure opening for additional cable
M	Enclosure opening for carrying handle

Symbols on the Inverter and on the Type Label

Symbol	Explanation
	Inverter Together with the green LED, this symbol indicates the operating state of the inverter.
	Observe the documentation Together with the red LED, this symbol indicates an error.
	Data transmission Together with the blue LED, this symbol indicates the status of the network connection.
	Grounding conductor This symbol indicates the position for connecting a grounding conductor.
	Grounding Dieses Symbol kennzeichnet den Ort für den Anschluss zusätzlicher Schutzleiter
	Risk of burns due to hot surfaces The product can get hot during operation. Avoid contact during operation. Prior to performing any work on the product, allow the product to cool down sufficiently.
	Danger to life due to electric shock The product operates at high voltages. Prior to performing any work on the product, disconnect the product from voltage sources. All work on the product must be carried out by qualified persons only.
	Observe the documentation Observe all documentation supplied with the product.

Symbol	Explanation
	Danger This symbol indicates that the inverter must be additionally grounded if additional grounding or equipotential bonding is required at the installation site.
	Direct current
	The product is has no galvanic isolation.
	Three-phase alternating current with neutral conductor
	WEEE designation Do not dispose of the product together with the household waste but in accordance with the disposal regulations for electronic waste applicable at the installation site.
	CE marking The product complies with the requirements of the applicable EU directives.
	Degree of protection IP65 The product is protected against dust intrusion and water jets from any angle.
	The product is suitable for outdoor installation.

4.2 Interfaces and Functions

The inverter can be equipped or retrofitted with the following interfaces and functions:

User interface for the monitoring and configuration of the inverter

The inverter is standard-equipped with an integrated web server, which provides a user interface for configuring and monitoring the inverter. The inverter user interface can be called up via the web browser if there is an existing WLAN or Ethernet connection to a computer, tablet PC or smartphone.

SMA Speedwire

The inverter is equipped with SMA Speedwire as standard. SMA Speedwire is a type of communication based on the Ethernet standard. This enables inverter-optimized 10 or 100 Mbit data transmission between Speedwire devices in PV systems and the user interface of the inverter.

SMA Webconnect

The inverter is equipped with a Webconnect function as standard. The Webconnect function enables direct data transmission between the inverters of a small-scale system and the Internet portal Sunny Portal without any additional communication device and for a maximum of 4 inverters per Sunny Portal system. In large-scale PV power plants with more than 4 inverters, there is the option of establishing data transmission between the inverters and the Sunny Portal web-based monitoring platform via the SMA Cluster Controller or to distribute the inverters over several plants in the Sunny Portal. If there is an existing WLAN or Ethernet connection, you can directly access your Sunny Portal system via the web browser on the computer, tablet PC or smartphone.

WLAN

The inverter is equipped with a WLAN interface as standard. The inverter is delivered with the WLAN interface activated as standard. If you do not want to use WLAN, you can deactivate the WLAN interface.

In addition, the inverter has a WPS (WiFi Protected Setup) function. The WPS function is for automatically connecting the inverter to a device in the same network as the inverter (e.g. router, computer, tablet PC or smartphone).

Expanding the radio range in the WLAN network

In order to expand the radio range of the inverter in the WLAN network, you can install the Antenna Extension Kit accessory set in the inverter.

Modbus

The inverter is equipped with a Modbus interface. The Modbus interface is deactivated by default and must be configured as needed.

The Modbus interface of the supported SMA devices is designed for industrial use and has the following tasks:

- Remote query of measured values
- Remote setting of operating parameters
- Setpoint specifications for system control

Module slots

The inverter is standard-equipped with two module slots. The module slots are located on the communication assembly and allow additional modules to be connected (e.g. SMA Sensor Module). The modules are available as accessories. The installation of two identical modules is not permissible.

Grid Management Services

The inverter is equipped with service functions for grid management.

Depending on the requirements of the grid operator, you can activate and configure the functions (e.g. active power limitation) via operating parameters.

Antenna Extension Kit

Within the WLAN network, the Antenna Extension Kit enables the radio range of the inverter to be upgraded (Information on assembly and connection see manual of the Antenna Extension Kit). The Antenna Extension Kit can be retrofitted.

SMA I/O modules

The SMA I/O Module enables the inverter to perform grid management services (for information on installation and connection, see the manual of the SMA I/O Module). The SMA I/O Module can be retrofitted.

SMA Sensor Module

The SMA Sensor Module has different interfaces for connecting various sensors (i.e. temperature sensor, irradiation sensor, anemometer or energy meter). The SMA Sensor Module converts the signals of the connected sensors and transmits them to the inverter. The SMA Sensor Module can be retrofitted.

Multifunction Relay

The inverter is equipped with a multifunction relay as standard. The multifunction relay is an interface that can be configured for the operating mode used by a particular system.

SMA OptiTrac Global Peak

SMA OptiTrac Global Peak is an advancement of SMA OptiTrac and allows the operating point of the inverter to follow the optimal operating point of the PV array (MPP) precisely at all times. In addition, with the aid of SMA OptiTrac Global Peak, the inverter detects several maximum power points in the available operating range, such as may occur particularly with partially shaded strings. SMA OptiTrac Global Peak is enabled by default.

String-Failure Detection

The string-failure detection measures the total current of every input and continuously calculates the mean values for the inputs in question. The total currents are compared with the mean values. If a total current exceeds or falls short of the mean value by the set tolerance value, event is reported. Marginally increased total currents are reliably detected over several query intervals and distinguished from typical current fluctuations of the PV array. String-failure detection is deactivated by default and must be activated. In addition, the tolerance value can be set via the user interface and the mean values read off.

Surge Arrester Type II

On the AC and DC side, the inverter is equipped with slots for type II surge protection devices. The surge protection devices limit dangerous overvoltages. The surge protection devices can be retrofitted.

5 Mounting

5.1 Requirements for Mounting

Requirements for the Mounting Location:

⚠ WARNING

Danger to life due to fire or explosion

Despite careful construction, electrical devices can cause fires.

- Do not mount the product in areas containing highly flammable materials or gases.
- Do not mount the product in potentially explosive atmospheres.

- The mounting location must be inaccessible to children.
- A solid, flat support surface must be available for mounting.
- The mounting location must be suitable for the weight and dimensions of the inverter (see Section 14 "Technical Data", page 96).
- The mounting location should be freely and safely accessible at all times without the need for any auxiliary equipment (such as scaffolding or lifting platforms). Non-fulfillment of these criteria may restrict servicing.
- The inverter can be mounted in a position that is directly exposed to solar irradiation. There is, however, the possibility that the inverter reduces its power output to avoid overheating due to high temperatures.
- The DC load-break switch of the inverter must always be freely accessible.
- Climatic conditions must be met (see Section 14 "Technical Data", page 96).

Dimensions for mounting:

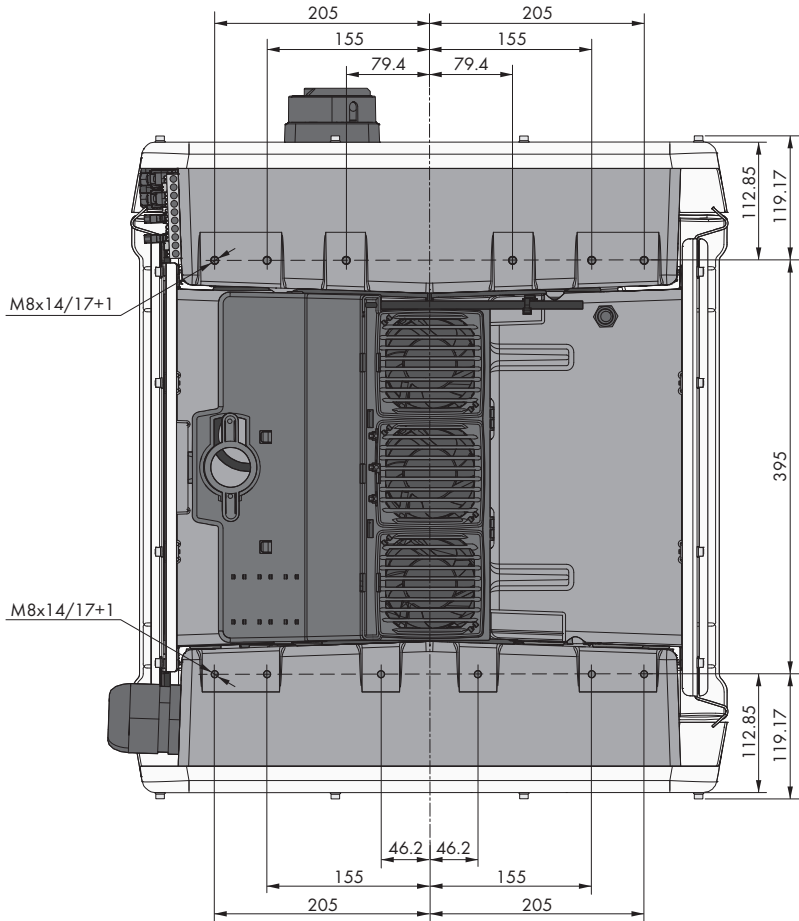
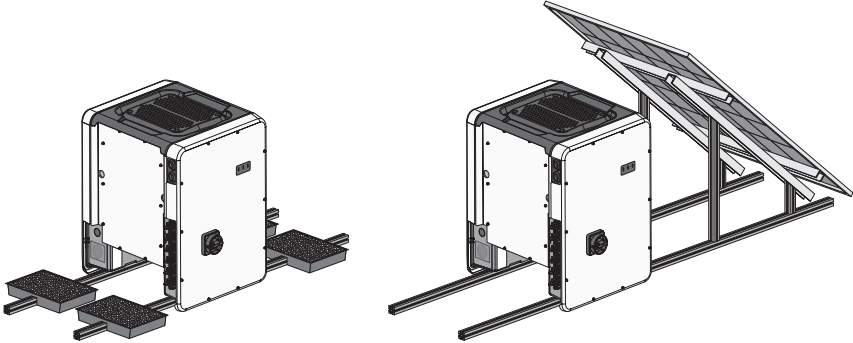

Figure 3: Position of the anchoring points (dimensions in mm (in))

Structural stability:

- When mounting with feet or profile rails, the width of one foot or the profile rail must be at least 175 mm to ensure structural stability.
- The inverter must be attached under the following conditions:
 - Inclination of the support surface: > 3°
 - Wind speed (without wind gusts): > 25 m/s
 - Height of the feet or the profile rail: > 100 mm

- When mounting with profile rails, an attachment or fixation by loading is required. When mounting with profile rail, SMA Solar Technology AG recommends to bolt the profile rail e.g. to the profile of the module frame or to attach a sheet metal (which can be weighted with stones or with sandbags) at the profile rails. This will ensure that the inverter is fixed.



Recommended clearances:

If you maintain the recommended clearances, adequate heat dissipation will be ensured. Thus, you will prevent power reduction due to excessive temperature.

- Maintain the recommended clearances to roof edges, skylights, walls as well as to other inverters or objects. This ensures that the DC load-break switch on the inverter can be operated easily and the LED signals can be read without difficulty.
- For possible service deployments, SMA Solar Technology AG recommends ensuring sufficient clearance from walls, other inverters or objects on all four sides of the inverter enclosure. Non-fulfillment of these criteria may restrict servicing.
- If multiple inverters are mounted in areas with high ambient temperatures, increase the clearances between the inverters and ensure sufficient fresh-air supply.

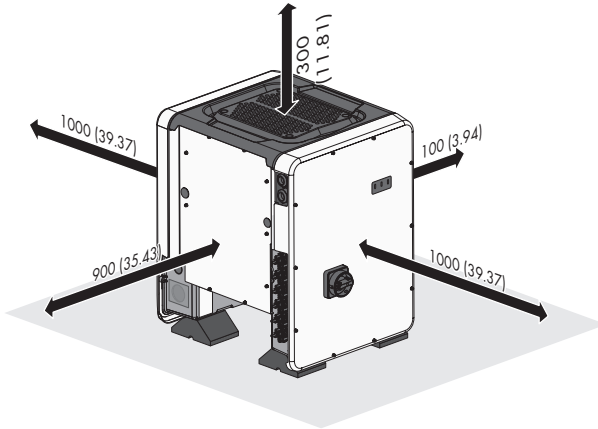

Figure 4: Recommended clearances (dimensions in mm (in))

Permitted and prohibited mounting positions:

- The inverter must only be mounted in one of the permitted positions. This will ensure that no moisture can penetrate the inverter.
- The inverter should be mounted in such a way that the LED signals can be read without difficulty.

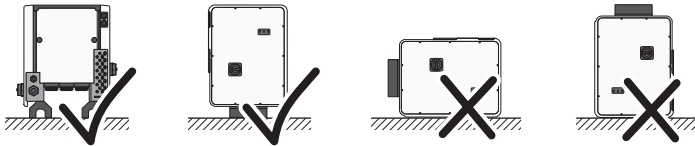

Figure 5: Permitted and prohibited mounting positions

5.2 Mounting the Inverter

⚠ QUALIFIED PERSON

⚠ CAUTION

Risk of injury when lifting the inverter, or if it is dropped

The inverter weighs 84 kg. You risk injury if you lift the inverter incorrectly or if it is dropped while being transported or mounted.

- Carry and lift the inverter upright with the help of several people. For this purpose, take hold of the carrying handles on the inverter. Always take hold of the two carrying handles mounted both on each side.
- Take into account the center of gravity of the inverter. The center of gravity is on the side of the AC connection unit.

Procedure:

1. Tighten every foot with two M8x40 hexagon screws and two washers on the two external taps (M8x14) on the underside of the inverter (torque: 16 Nm).

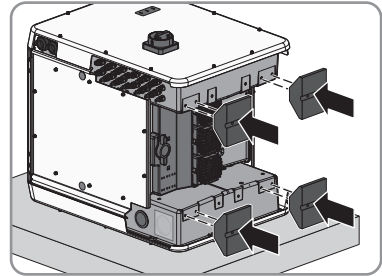

2. Screw all four transport handles as far as they will go into the taps on the right- and left-hand side until they lie flush with the enclosure. When doing so, ensure that the transport handles are screwed into the taps so that they are perfectly straight. If the transport handles are not screwed in straight, this can make it more difficult or even impossible to unscrew them later on and can damage the taps to the extent that transport handles can no longer be screwed into them.

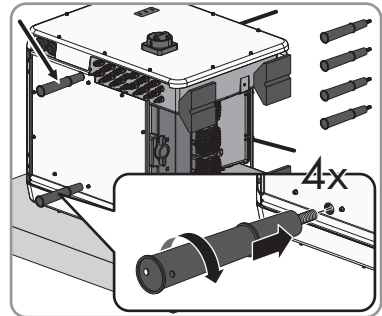

3. Insert a screwdriver into the holes in the transport handle and turn the screwdriver through 90°. This ensures that the transport handles are securely tightened.

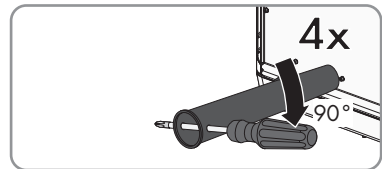

4. Remove the inverter from the Euro pallet and position the inverter at the installation location.

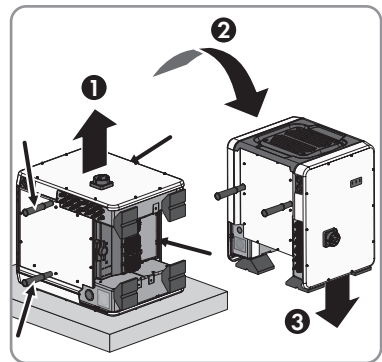

5. Make sure that the inverter is stable.

6. Remove all four transport handles from the taps. If necessary, insert a screwdriver into the holes on the transport handle and use the screwdriver to remove the transport handle.

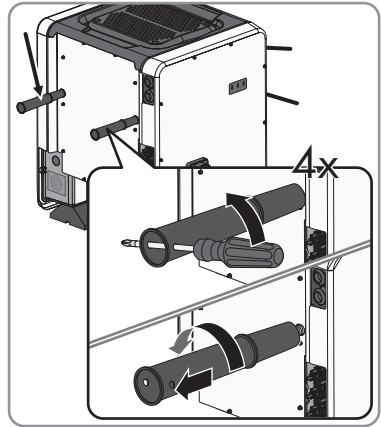

6 Electrical Connection

6.1 Safety during Electrical Connection

⚠ DANGER

Danger to life due to high voltages of the PV array

When exposed to sunlight, the PV array generates dangerous DC voltage, which is present in the DC conductors and the live components of the inverter. Touching the DC conductors or the live components can lead to lethal electric shocks. If you disconnect the DC connectors from the inverter under load, an electric arc may occur leading to electric shock and burns.

- Do not touch non-insulated cable ends.
- Do not touch the DC conductors.
- Do not touch any live components of the inverter.
- Have the inverter mounted, installed and commissioned only by qualified persons with the appropriate skills.
- If an error occurs, have it rectified by qualified persons only.
- Prior to performing any work on the inverter, disconnect it from all voltage sources as described in this document.

NOTICE

Damage to seals on the enclosure lids in subfreezing conditions

If you open the enclosure lids when temperatures are below freezing, the enclosure seals can be damaged. This can lead to moisture entering the inverter.

- Only open the enclosure lids if the ambient temperature is not below -5°C
- If a layer of ice has formed on the seal of the lid when temperatures are below freezing, remove it prior to opening the enclosure lids (e.g. by melting the ice with warm air). Observe the applicable safety regulations.

NOTICE

Damage to the inverter due to electrostatic discharge

Touching electronic components can cause damage to or destroy the inverter through electrostatic discharge.

- Ground yourself before touching any component.

6.2 Overview of the Connection Area

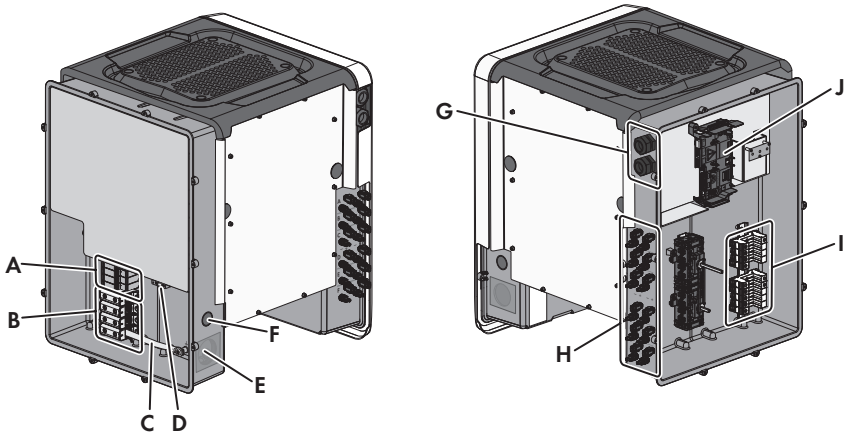

Figure 6: Connection areas of the inverters' AC Connection Unit and DC Connection Unit

Position	Designation
A	Slots for AC surge protection devices
B	Terminal blocks for AC connection
C	Bridge between N and enclosure
D	Grounding terminal for grounding conductor connection
E	Enclosure opening for cable gland M63
F	Enclosure opening for additional cable
G	Cable glands for network cables and, if needed, for the connection cables of the Antenna Extension Kit or other data cables
H	Positive and negative connectors for DC connection
I	Slots for DC surge protection devices
J	Communication assembly

6.3 AC Connection

6.3.1 Requirements for the AC Connection

Cable requirements:

- The conductors must be made of aluminum or copper.
- External diameter: 35 mm to 48 mm
- Conductor cross-section: 35 mm² to 120 mm²

- Insulation stripping length: 30 mm
- Sheath stripping length: 290 mm
- The cable must be dimensioned in accordance with the local and national directives for the dimensioning of cables. The requirements for the minimum wire size derive from these directives. Examples of factors influencing cable dimensioning are: nominal AC current, type of cable, routing method, cable bundling, ambient temperature and maximum desired line losses (for calculation of line losses, see the design software "Sunny Design" from software version 2.0 at www.SMA-Solar.com).

Overview of the required length of the conductor inside the AC connection unit

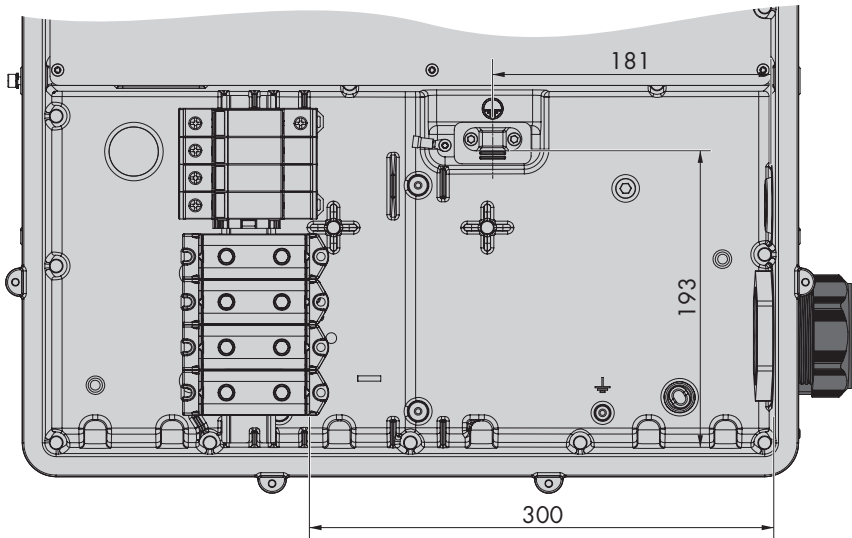

Figure 7: Inner view of the AC connection unit with dimensions for the conductor (measurements in mm (in))

Load-break switch and cable protection:

- In PV systems with multiple inverters, protect each inverter with a separate three-phase circuit breaker. Make sure to observe the maximum permissible fuse protection (see Section 14 "Technical Data", page 96). This will prevent residual voltage being present at the corresponding cable after disconnection.
- Loads installed between the inverter and the circuit breaker must be fused separately.

Residual-current monitoring unit:

- If an external residual-current device is required, install a type B residual-current device that trips at a residual current of 500 mA or higher (for details on selecting a residual-current device, see the Technical Information ""Criteria for Selecting a Residual-Current Device"" at www.SMA-Solar.com). Residual-current devices with a tripping threshold < 500 mA can be used. The tripping threshold of 300 mA must not be undershot.

- If a residual-current device with a tripping threshold < 500 mA is used, you must set the tripping threshold of the residual-current device in the inverter (see Section 9.6, page 62).

Overvoltage category:

The inverter can be used in grids of overvoltage category III or lower in accordance with IEC 60664-1. That means that the inverter can be permanently connected to the grid-connection point of a building. In case of installations with long outdoor cabling routes, additional measures to reduce overvoltage category IV to overvoltage category III are required (see the Technical Information "Overvoltage Protection" at www.SMA-Solar.com).

6.3.2 Connecting the Inverter to the Utility Grid

⚠ QUALIFIED PERSON

Requirements:

- The connection requirements of the grid operator must be met.
- The grid voltage must be in the permissible range. The exact operating range of the inverter is specified in the operating parameters.

Procedure:

1. Disconnect the circuit breaker from all three line conductors and secure against reconnection.
2. Ensure that the DC load-break switch is in the **O** position and is secured against reconnection.
3. If the enclosure lid of the AC Connection Unit is mounted, remove all ten screws of the enclosure lid using a Torx screwdriver (TX 25) and remove the enclosure lid towards the front.

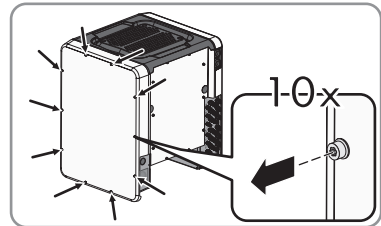

4. Remove the adhesive tape from the enclosure opening for the AC connection.
5. Insert the cable gland M63 into the opening and screw the counter nut on from the inside.

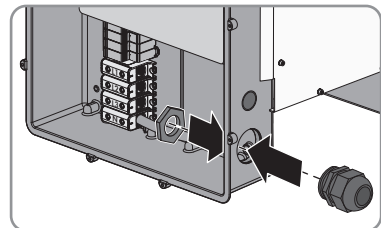

6. Thread the AC cable through the cable gland into the AC Connection Unit. If necessary, slightly loosen the swivel nut of the cable gland.
7. Dismantle the AC cable.
8. Strip off the insulation of L1, L2, L3, N and PE by 30 mm.

9. Connect the grounding conductor to the ground terminal. Use a Torx screwdriver (TX 25) to slightly loosen one of the screws with which the clip and connection plate are connected to the ground connection and to completely remove the other screw. Then place the grounding conductor onto the connection plate, route the clip via the grounding conductor and tighten both screws with a Torx screwdriver (TX 25) (torque: 6 Nm).

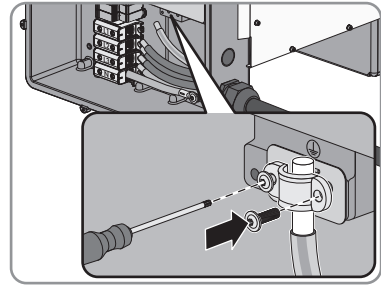

10. Ensure that the conductor is on the connection plate.
11. Connect L1, L2, L3 and, if necessary, N to the terminals according to the label. To do so, position each conductor as far as they will go into the corresponding terminal and tighten the screw of the terminal using an Allen key (AF 8) (20 Nm torque for a conductor cross-section of 35 mm² to 95 mm²; 30 Nm torque for a cable cross-section of 120 mm²).

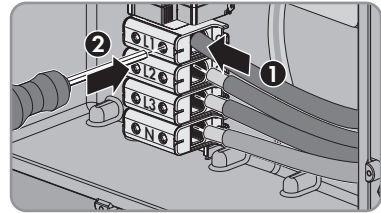

12. **⚠ WARNING**

Danger to life due to electric shock

The inverter is delivered with a bridge between N and the enclosure as standard. The bridge is absolutely essential if the connection to a utility grid is established without a neutral conductor. If the utility grid is connected with a neutral conductor, the bridge must always be removed.

- When N is present and connected to the corresponding terminal, remove the default bridge between N and the enclosure (\perp).

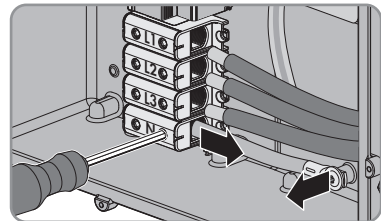

13. Ensure that the correct conductors are assigned to all the terminals.
14. Make sure that all conductors are securely in place.

6.4 DC Connection

6.4.1 Requirements for the DC Connection

Requirements for the PV modules per input:

- All PV modules must be of the same type.
- All PV modules must be aligned and tilted identically.

- On the coldest day based on statistical records, the open-circuit voltage of the PV array must never exceed the maximum input voltage of the inverter.
- The same number of series-connected PV modules must be connected to each string.
- The maximum input current per string must be maintained and must not exceed the through-fault current of the DC connectors (see Section 14 "Technical Data", page 96).
- The thresholds for the input voltage and the input current of the inverter must be adhered to (see Section 14 "Technical Data", page 96).
- The positive connection cables of the PV modules must be fitted with the positive DC connectors (for information on assembling DC connectors, see the DC connector installation manual).
- The negative connection cables of the PV modules must be fitted with the negative DC connectors (for information on assembling DC connectors, see the DC connector installation manual).

i Use of Y adapters for parallel connection of strings

The Y adapters must not be used to interrupt the DC circuit.

- Do not use the Y adapters in the immediate vicinity of the inverter. The adapters must not be visible or freely accessible.
- In order to interrupt the DC circuit, always disconnect the inverter as described in this document (see Section 10, page 67).

6.4.2 Assembling the DC Connectors

⚠ QUALIFIED PERSON

For connection to the inverter, all PV module connection cables must be fitted with the DC connectors provided. Assemble the DC connectors as described in the following. Be sure to observe the correct polarity. The DC connectors are marked with the symbols "+" and "-".

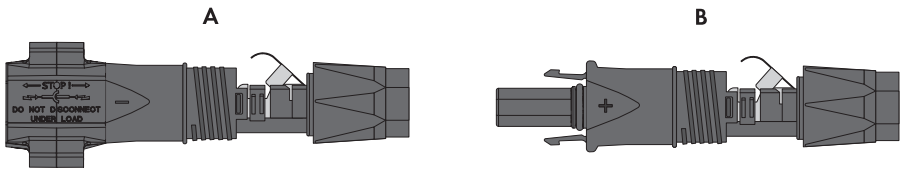

Figure 8: Negative (A) and positive (B) DC connectors

Cable requirements:

- Cable type: PV1-F, UL-ZKLA, USE2
- External diameter: 5 mm to 8 mm
- Conductor cross-section: 2.5 mm² to 6 mm²
- Qty single wires: minimum 7
- Nominal voltage: minimum 1000 V

- Using bootlace ferrules is not allowed.

⚠ DANGER

Danger to life due to high voltages on the DC conductors

When exposed to sunlight, the PV array generates dangerous DC voltage which is present in the DC conductors. Touching the DC conductors can lead to lethal electric shocks.

- Ensure that the inverter is disconnected from all voltage sources.
- Do not touch non-insulated cable ends.
- Do not touch the DC conductors.

NOTICE

Destruction of the inverter due to overvoltage

If the open-circuit voltage of the PV modules exceeds the maximum input voltage of the inverter, the inverter can be destroyed due to overvoltage.

- If the open-circuit voltage of the PV modules exceeds the maximum input voltage of the inverter, do not connect any strings to the inverter and check the design of the PV system.

Procedure:

1. Strip 12 mm of the cable insulation.
2. Insert the stripped cable into the DC connector up to the stop. When doing so, ensure that the stripped cable and the DC connector are of the same polarity.
3. Press the clamping bracket down until it audibly snaps into place.

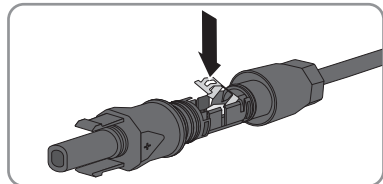
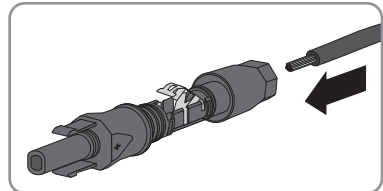

- ☑ The stranded wire can be seen inside the clamping bracket chamber.

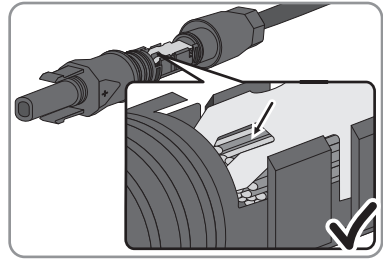

- ✘ The stranded wire cannot be seen in the chamber?

The cable is not correctly in place.

- Release the clamping bracket. To do so, insert a screwdriver (blade width: 3.5 mm) into the clamping bracket and pry the clamping bracket open.

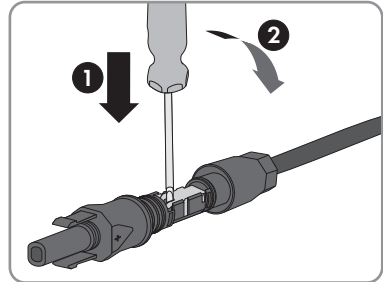

- Remove the cable and go back to step 2.

4. Push the swivel nut up to the thread and tighten (torque: 2 Nm).

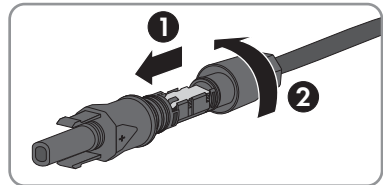

6.4.3 Connecting the PV Array

⚠ QUALIFIED PERSON

NOTICE

Damage to the DC connectors due the use of contact cleaner of other cleaning agents

Some contact cleaners or other cleaning agents may contain substances that decompose the plastic of the DC connectors.

- Do not use contact cleaners or other cleaning agents for cleaning the DC connectors.

NOTICE**Destruction of the inverter due to overvoltage**

If the open-circuit voltage of the PV modules exceeds the maximum input voltage of the inverter, the inverter can be destroyed due to overvoltage.

- If the open-circuit voltage of the PV modules exceeds the maximum input voltage of the inverter, do not connect any strings to the inverter and check the design of the PV system.

NOTICE**Destruction of the measuring device due to overvoltage**

- Only use measuring devices with a DC input voltage range of 1000 V or higher.

Procedure:

1. Ensure that the circuit breaker is switched off and that it cannot be reconnected.
2. Set the DC load-break switch of the inverter to position **O**.
3. Secure the DC load-break switch against reconnection using a padlock.
4. Measure the PV array voltage. Ensure that the maximum input voltage of the inverter is adhered to and that there is no ground fault in the PV array.
5. Check whether the DC connectors have the correct polarity.

If the DC connector is equipped with a DC cable of the wrong polarity, the DC connector must be reassembled. The DC cable must always have the same polarity as the DC connector.

6. Ensure that the open-circuit voltage of the PV array does not exceed the maximum input voltage.
7. Connect the assembled DC connectors to the inverter.

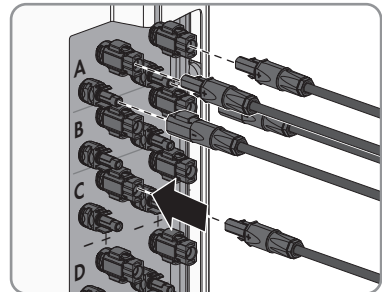

- The DC connectors snap into place.

8. Ensure that all DC connectors are securely in place.

9. **NOTICE****Damage to the inverter due to moisture ingress**

If the electrical connection is not made immediately after the installation, the inverter is not sealed and moisture can penetrate the inverter. The inverter is only sealed if the DC connectors are connected to the inverter with the DC conductors or with sealing plugs.

If the electrical connection is to be carried out at a later time, close the DC inputs on the inverter with DC connectors and sealing plugs as described below.

- Do not insert the sealing plugs directly into the DC inputs on the inverter.
 - For unused DC connectors, push down the clamping bracket and push the swivel nut up to the thread.
 - Insert the sealing plug into the DC connector.
-
- Insert the DC connectors with sealing plugs into the corresponding DC inputs on the inverter.

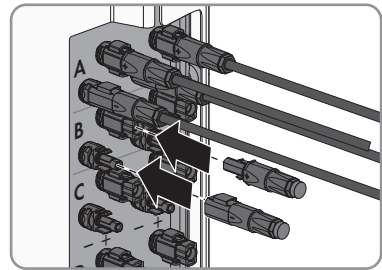
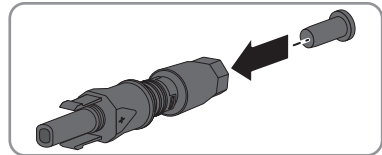

- The DC connectors snap into place.
- Ensure that the DC connectors with sealing plugs are securely in place.

6.4.4 Disassembling the DC Connectors**⚠ QUALIFIED PERSON**

To disassemble the DC connectors (e.g. due to faulty assembly), proceed as follows.

⚠ DANGER**Danger to life due to high voltages on the DC conductors**

When exposed to sunlight, the PV array generates dangerous DC voltage which is present in the DC conductors. Touching the DC conductors can lead to lethal electric shocks.

- Ensure that the inverter is disconnected from all voltage sources.
- Do not touch non-insulated cable ends.
- Do not touch the DC conductors.

Procedure:

1. Release and remove all DC connectors. To do this, insert a flat-blade screwdriver or an angled screwdriver (blade width 3.5 mm) into one of the slide slots and pull the DC connectors out in a downward direction. Do not pull on the cable.

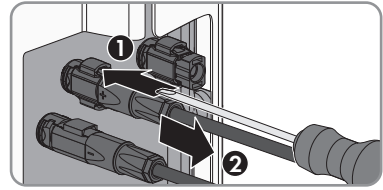

2. Remove the DC connector swivel nut.

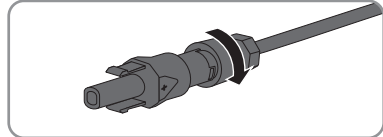

3. Unlock the DC connector. To do this, insert a flat-blade screwdriver (blade width: 3.5 mm) into the side catch mechanism and pry the catch mechanism open.

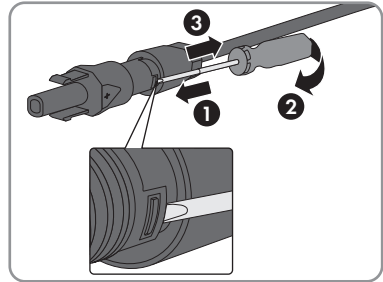

4. Carefully pull the DC connector apart.

5. Release the clamping bracket. To do so, insert a flat-blade screwdriver (blade width: 3.5 mm) into the clamping bracket and pry the clamping bracket open.

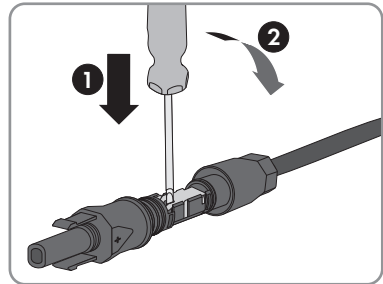

6. Remove the cable.

6.5 Connecting the Multifunction Relay

6.5.1 Procedure for connecting the multifunction relay

QUALIFIED PERSON

Procedure	See
1. Select for which operating mode you would like to use the multifunction relay.	Section 6.5.2, page 35
2. Connect to the multifunction relay according to the operating mode and the associated connection variant.	Section 6.5.3, page 35 and Section 6.5.4, page 39
3. After commissioning the inverter, change the operating mode of the multifunction relay, if necessary.	Section 9.4, page 60

6.5.2 Operating Modes of the Multifunction Relay

Operating mode of multifunction relay (Mlt.Op-Mode)	Description
Fault indication (FltInd)	The multifunction relay controls a display device (e.g. a warning light) which, depending on the type of connection, signals either an error or the undisturbed operation of the inverter.
Self-consumption (SelfC-mp)	The multifunction relay switches loads on or off, depending on the power production of the PV system.
Control via communication (ComCtl)	The multifunction relay switches loads on or off according to commands transmitted by a communication product.
Battery bank (BatCha)	The multifunction relay controls the charging of the batteries depending on the power production of the PV system.
Fan control (FanCtl)	The multifunction relay controls an external fan, depending on the temperature of the inverter.
Switching status grid relay (GriSwCpy)	The local grid operator may require that a signal is transmitted as soon as the inverter connects to the utility grid. The multifunction relay can be used to trigger this signal.

6.5.3 Connection Options

The connection procedures vary, depending on the operating mode.

Operating mode	Connection option
Fault indication (FltInd)	Using the Multifunction Relay as a Fault Indicator Contact
Self-consumption (SelfC-mp)	Controlling loads via the multifunction relay or charging batteries depending on the power production of the PV system

Operating mode	Connection option
Control via communication (ComCtl)	Controlling loads via the multifunction relay or charging batteries depending on the power production of the PV system
Battery bank (BatCha)	Controlling loads via the multifunction relay or charging batteries depending on the power production of the PV system
Fan control (FanCtl)	Connecting the external fan (see fan documentation)
Switching status grid relay (GriSwCpy)	Reporting the switching status of the grid relay

Using the Multifunction Relay as a Fault Indicator Contact

You can use the multifunction relay as a fault indicator contact and have an error or smooth operation of the inverter displayed or signaled via a suitable display device. You can connect multiple inverters to one fault indicator or operation indicator, as needed.

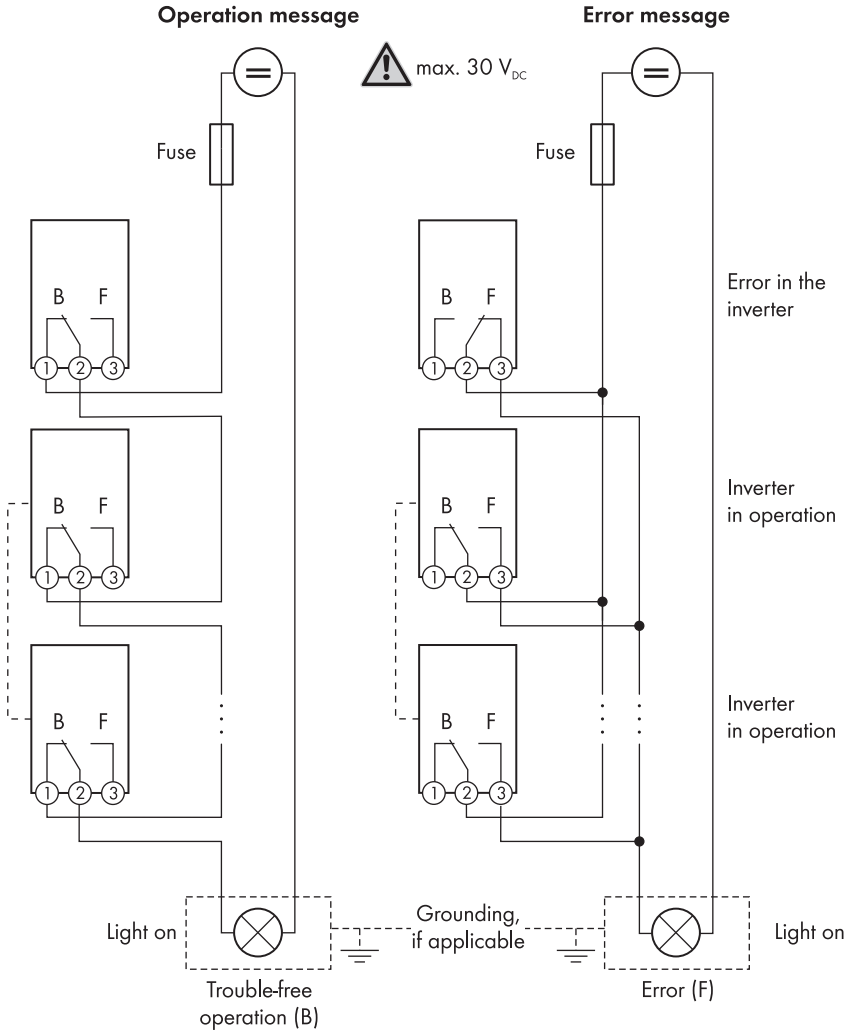

Figure 9: Circuit diagram with multiple inverters for connection to an operation indicator and circuit diagram for connection to a fault indicator (example)

Controlling loads via the multifunction relay or charging batteries depending on the power production of the PV system

The multifunction relay can control loads or charge batteries power-dependently. To enable this function, you must connect a contactor (K1) to the multifunction relay. The contactor (K1) switches the operating current for the load on or off. If you want batteries to be charged depending on the available power, the contactor activates or deactivates the charging of the batteries.

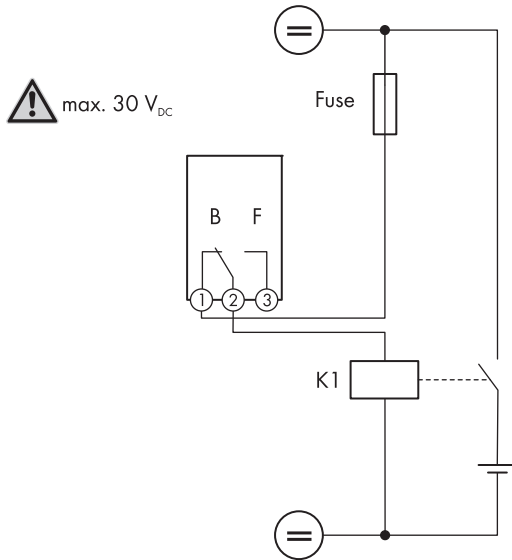

Figure 10: Wiring diagram for connection for controlling a load or for the power-dependent charging of the batteries

Reporting the switching status of the grid relay

The multifunction relay can trip a signal to the grid operator as soon as the inverter connects to the utility grid. To enable this function, the multifunction relays of all inverters must be connected in parallel.

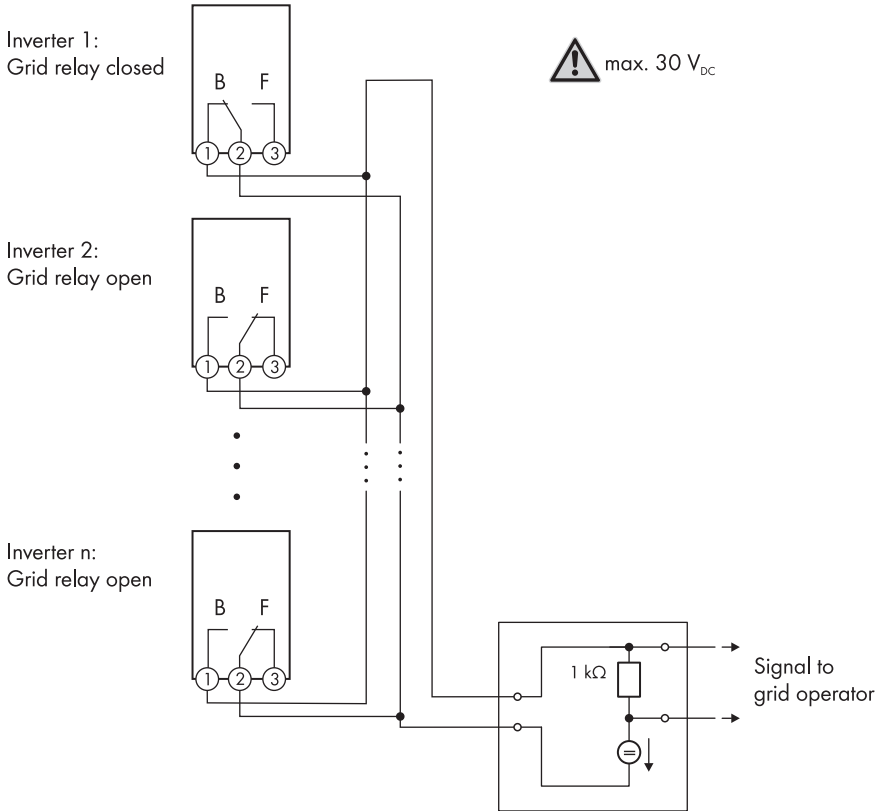

Figure 11: Wiring diagram for signaling the switching status of the grid relay (example)

6.5.4 Connection to the Multifunction Relay

⚠ QUALIFIED PERSON

Requirement:

- The technical requirements of the multifunction relay must be met (see Section 14 "Technical Data", page 96).

Cable requirements:

- Conductor cross-section: 0.2 to 1.5 mm²
- The cable type and cable-laying method must be appropriate for the application and location.

Procedure:1. **⚠ DANGER****Danger to life due to high voltages**

- Disconnect the inverter from all voltage sources (see Section 10, page 67).

2. If the enclosure lid of the DC Connection Unit is closed, remove it as follows: Unscrew all ten screws with a Torx screwdriver (TX 25) and remove the enclosure lid carefully forward.

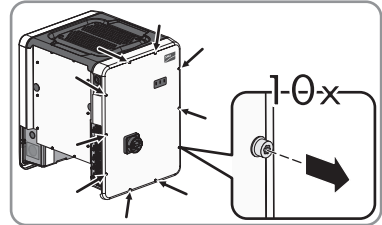

3. Set the screws and the enclosure lid aside and store safely.
4. Remove the swivel nut from the cable gland for the communication cable.
5. Remove the two-hole cable support sleeve from the cable gland and insert the cable into the enclosure opening of the two-hole cable support sleeve.
6. Press the two-hole cable support sleeve with the cable into the cable gland and guide the cable to the communication assembly in the DC Connection Unit. Ensure that any unused enclosure openings of the two-hole cable support sleeve are sealed with sealing plugs.
7. Strip 9 mm (0.35 in) of the cable insulation at maximum.

8. Connect the cable to the 3-pole terminal block according to the circuit diagram, depending on the operating mode (see Section 6.5.3, page 35). Ensure that the conductors are plugged completely into the terminal points up to their insulation.

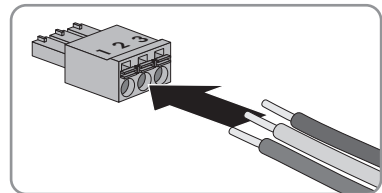

9. Stick the 3-pole terminal block with the connected conductors into the **MFR** slot on the communication assembly in the inverter.

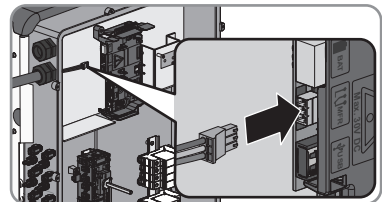

10. Ensure that the terminal block is securely in place.
11. Ensure that all conductors are correctly connected.
12. Ensure that the conductors sit securely in the terminal points.
Useful hint: To release the conductors, open the terminal points using a suitable tool.
13. Tighten the swivel nut on the cable gland hand-tight.

6.6 Connecting the Network Cables

QUALIFIED PERSON

DANGER

Danger to life due to electric shock

Overvoltages (e. g. in the case of a flash of lightning) can be further conducted into the building and to other connected devices in the same network via the network cable if there is no overvoltage protection.

- Ensure that all devices in the same network are integrated in the existing overvoltage protection.
- When laying the network cable outdoors, attention must be given to suitable overvoltage protection at the network cable transition from the inverter outdoors to the network inside the building.
- The Ethernet interface of the inverter is classified as "TNV-1" and offers protection against overvoltages up to 1.5 kV.

Additionally required material (not included in the scope of delivery):

- Network cables
- Where required: Field-assembly RJ45 connector.

Cable requirements:

The cable length and quality affect the quality of the signal. Observe the following cable requirements.

- Cable type: 100BaseTx
- Cable category: Cat5, Cat5e, Cat6, Cat6a or Cat7
- Plug type: RJ45 of Cat5, Cat5e, Cat6 or Cat6a
- Shielding: SF/UTP, S/UTP, SF/FTP or S/FTP
- Number of insulated conductor pairs and insulated conductor cross-section: at least 2 x 2 x 0.22 mm²
- Maximum cable length between two nodes when using patch cables: 50 m
- Maximum cable length between two nodes when using installation cables: 100 m
- UV-resistant for outdoor use

Procedure:

1. DANGER

Danger to life due to electric shock

- Disconnect the inverter from all voltage sources (see Section 10, page 67).

2. If the enclosure lid of the DC Connection Unit is closed, remove it as follows: Unscrew all ten screws with a Torx screwdriver (TX 25) and remove the enclosure lid carefully forward.

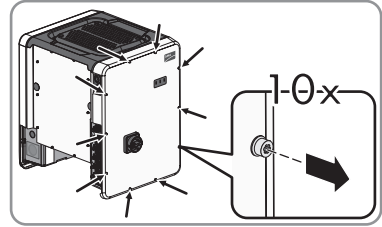

3. Set the screws and the enclosure lid aside and store safely.
4. Remove the swivel nut from the cable gland for the communication cable.
5. Thread the swivel nut over the network cable.
6. Remove the two-hole cable support sleeve from the cable gland.
7. Remove the sealing plug from one of the enclosure openings of the two-hole cable support sleeve and insert the network cable into the enclosure opening.
8. Press the two-hole cable support sleeve with the cable into the cable gland and guide the network cable to the communication assembly in the DC Connection Unit. Ensure that any unused enclosure openings of the two-hole cable support sleeve are sealed with sealing plugs.
9. When using a self-assembly network cable, assemble the RJ45 connector and connect to the network cable (see connector documentation).
10. Put the RJ45 plug of the cable into one of the network sockets of the communication assembly.

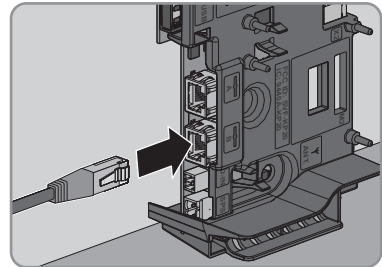

11. Ensure that the RJ45 plug is securely in place by pulling slightly on the cable.
12. Tighten the swivel nut on the cable gland hand-tight. This will secure the network cable in place.
13. If the inverter is installed outdoors, install overvoltage protection for all components in the network.
14. If you would like to connect the inverter in a local network, connect the other end of the network cable to the local network (e. g. via a router).

7 Commissioning

7.1 Commissioning Procedure

QUALIFIED PERSON

This section describes the commissioning procedure and gives an overview of the steps you must perform in the prescribed order.

Procedure	See
1. Commission the inverter.	Section 7.2, page 43
2. Establish a connection to the user interface of the inverter. There are two connection options available to choose from: <ul style="list-style-type: none"> • Direct connection via WLAN • Connection via Ethernet in the local network 	Section 8.1, page 49
3. Log into the user interface.	Section 8.2, page 52
4. Select the inverter configuration option. Please note that the personal SMA Grid Guard code for changing the grid-relevant parameters must be available after completion of the first ten feed-in hours or installation assistant (see "Application for the SMA Grid Guard code" available at www.SMA-Solar.com).	Section 7.4, page 45
5. Ensure that the country data set has been configured correctly.	Section 9.3, page 60
6. For PV systems in Italy: Start the self-test.	Section 7.3, page 44
7. Make further inverter settings as needed.	Section 9, page 58

7.2 Commissioning the Inverter

QUALIFIED PERSON

Requirements:

- The AC circuit breaker must be correctly rated and mounted.
- The inverter must be correctly mounted.
- All cables must be correctly connected.
- Unused enclosure openings must be sealed tightly with sealing plugs.

Procedure:

1. Position the enclosure lid of the AC connection unit on the AC connection unit and first tighten the upper-left and lower-right screws, and then the remaining screws crosswise using a Torx screwdriver (TX 25) (torque: 6 Nm).

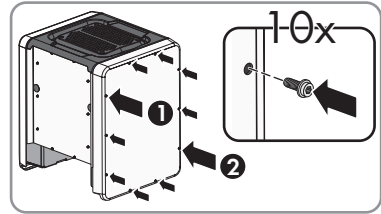

2. Position the enclosure lid of the DC connection unit on the DC connection unit and first tighten the upper-left and lower-right screws, and then the remaining screws crosswise using a Torx screwdriver (TX 25) (torque: 6 Nm).

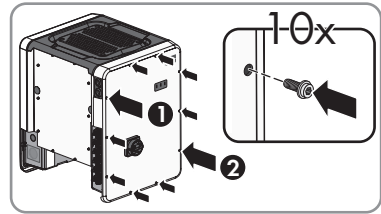

3. Turn the DC load-break switch of the inverter to position I. To do so, first remove the padlock.

4. Switch on the AC circuit breaker.

- ☑ All three LEDs light up. The start-up phase begins.
- ☑ All three LEDs go out again after approximately 90 seconds.
- ☑ Depending on the available power, the green LED pulses or is continuously illuminated. The inverter is feeding in.
- ✘ The green LED is still flashing?

The conditions for activating feed-in operation are not yet met.

- As soon as the conditions for feed-in operation are met, the inverter starts with feed-in operation and, depending on the available power, the green LED will light up continuously or it will pulse.

- ✘ The red LED is glowing?

An event has occurred.

- Find out which event has occurred and, if necessary, initiate countermeasures.

7.3 Starting the Self-Test (For Italy Only)

⚠ QUALIFIED PERSON

The self-test is only required for inverters to be commissioned in Italy. The Italian standard requires that all inverters feeding into the utility grid are equipped with a self-test function in accordance with CEI 0-21. During the self-test, the inverter will consecutively check the reaction times for overvoltage, undervoltage, maximum frequency and minimum frequency.

The self-test changes the upper and lower disconnection values for each protective function on a linear basis for frequency monitoring and voltage monitoring. As soon as the measured value exceeds the permitted disconnection threshold, the inverter disconnects from the utility grid. In this way, the inverter determines the reaction time and checks itself.

After the self-test has been completed, the inverter automatically switches back to feed-in operation, resets the original disconnection conditions and connects to the utility grid. The test takes approximately three minutes.

Requirements:

- The country data set of the inverter must be set to **CEI 0-21 internal**.

Procedure:

1. Select the menu **Device Configuration**.
2. Select **[Settings]**.
3. Select **[Starting the Self-Test]** in the subsequent context menu.
4. Observe the instructions shown in the dialog and save the report of the self-test, if necessary.

7.4 Selecting a configuration option

QUALIFIED PERSON

After you have logged onto the user interface as **Installer**, the **Configuring the Inverter** page opens.

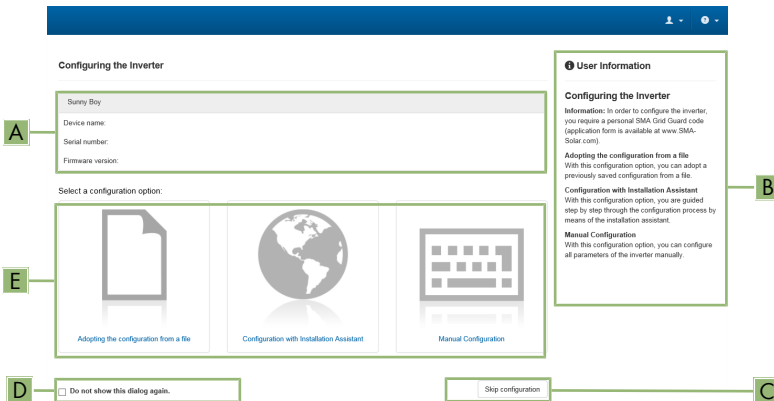

Figure 12: Layout of the **Configuring the Inverter** page

Position	Designation	Description
A	Device information	Provides the following information: <ul style="list-style-type: none"> • Device name • Inverter serial number • Inverter firmware version

Position	Designation	Description
B	User information	Provides brief information on the listed configuration options
C	Skip configuration	Offers the option of skipping the inverter configuration and go directly to the user interface (not recommended)
D	Checkbox	Allows you to choose not to have the displayed page displayed again when the user interface is called up again
E	Configuration options	Provides a selection of the various configuration options

Procedure:

On the **Configuring the Inverter** page, different configuration options are available to choose from. Select one of the options and proceed for the selected option as described below. SMA Solar Technology AG recommends carrying out the configuration with the installation assistant. This way, you ensure that all relevant parameters are set for optimal inverter operation.

- Adoption of configuration from a file
- Configuration with the installation assistant (recommended)
- Manual configuration

Accepting the settings

Saving the made settings is indicated by an hourglass symbol on the user interface. If the DC voltage is sufficient, the data is transferred directly to the inverter and accepted. If the DC voltage is too low (e. g. in the evening), the settings are saved, but they cannot be directly transferred to or accepted by the inverter. As long as the inverter has not yet received and accepted the settings, the hourglass symbol will continue to be displayed on the user interface. The settings will be accepted when there is sufficient DC voltage applied and the inverter restarts. As soon as the hourglass symbol appears on the user interface, the settings have been saved. The settings will not be lost. You can log off of the user interface and leave the system.

Adopting the Configuration from a File

You can adopt the inverter configuration from a file. To do this, there must be an inverter configuration saved to a file.

Procedure:

1. Select the configuration option **Adopting configuration from a file**.
2. Select [**Browse...**] and select the desired file.
3. Select [**Import file**].

Configuring the Installation Assistant (Recommended)

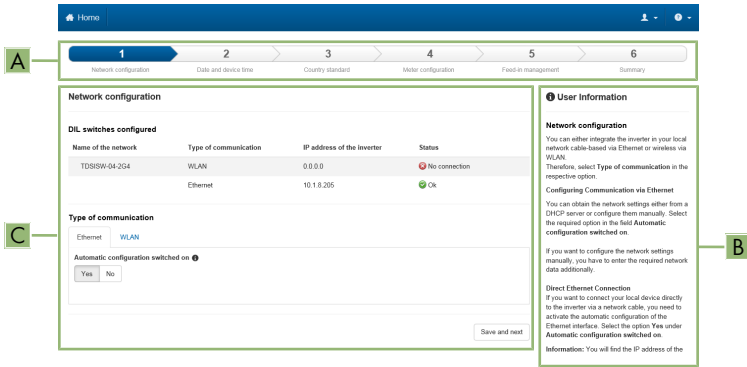

Figure 13: Layout of the installation assistant (example)

Position	Designation	Description
A	Configuration steps	Overview of the installation assistant steps. The number of steps depends on the type of device and the additionally installed modules. The current step is highlighted in blue.
B	User information	Information about the current configuration step and the setting options of the configuration step.
C	Configuration field	You can make settings in this field.

Procedure:

1. Select the configuration option **Configuration with Installation Assistant**.
 - The installation assistant will open.
2. Follow the installation assistant steps and make the settings appropriate for your system.
3. For every setting made in a step, select [**Save and next**].
 - In the last step, all made settings are listed in a summary.
4. To save the settings to a file, select [**Export a summary**] and save the file on your computer, tablet PC or smartphone.
5. To correct settings you made, select [**Back**], navigate to the desired step, correct settings and select [**Save and continue**].
6. Once all settings are correct, select [**Next**] in the summary.
 - The start page of the user interface opens.

Manual configuration

You can configure the inverter manually by setting the desired parameters.

Procedure:

1. Select the configuration option **Manual Configuration**.
 - The **Device Parameters** menu on the user interface will open and all available parameter groups of the inverter will be displayed.
 2. Select [**Edit parameters**].
 3. Select the desired parameter group.
 - All available parameters of the parameter group will be displayed.
 4. Set the desired parameters.
 5. Select [**Save all**].
- The inverter parameters are set.

8 Using the Inverter User Interface

8.1 Establishing a connection to the user interface

8.1.1 Establishing a direct connection via WLAN

Requirements:

- The inverter must be commissioned.
- A computer, tablet PC or smartphone with WLAN interface must be available.
- In the case of a computer connection, one of the following web browsers must be installed: Firefox (as of version 25), Internet Explorer (as of version 10), Safari (as of version 7), Opera (as of version 17) or Google Chrome (as of version 30).
- In the case of a tablet PC or smartphone connection, one of the following web browsers must be installed: Firefox (as of version 25), Safari (as of version iOS 7) or Google Chrome (as of version 29).
- The personal SMA Grid Guard code of the Installer must be available for the changing of grid-relevant settings after completion of the first ten operating hours (see "Application for SMA Grid Guard Code" at www.SMA-Solar.com).

Inverter SSID and IP address and necessary passwords

- Inverter SSID in WLAN: SMA[serial number] (e.g. SMA2130019815)
- Standard WLAN password (usable for initial configuration to completion of the first ten operating hours): SMA 12345
- Device-specific WLAN password (usable for initial configuration to completion of the first ten operating hours): see WPA2-PSK on the type label of the inverter or on the back of the manual included in the delivery
- Standard IP inverter address for a direct connection via WLAN outside of a local network: 192.168.12.3

Importing and exporting files with end devices having an iOS operating system is not possible.

For technical reasons, importing and exporting files (e.g. importing an inverter configuration, saving the current inverter configuration or exporting events) is not possible with mobile end devices having an iOS operating system.

- Use an end device that does not have an iOS operating system for importing and exporting files.

The procedure can be different depending on the terminal devices used (e.g. computer, tablet PC or smartphone). If the procedure described does not apply to your device, establish the direct connection via WLAN as described in the manual of your device.

Procedure:

1. If your computer, tablet PC or smartphone has a WPS function:
 - Activate the WPS function on the inverter. To do this, tap twice in succession on the enclosure lid of the DC connection unit next to the LEDs.
 - The blue LED flashes quickly for approx. two minutes. The WPS function is active.
 - Activate the WPS on your device.
 - The connection with your device will be established automatically. It can take up to 20 seconds for this connection to be established.
2. If your computer, tablet PC or smartphone does not have a WPS function:
 - Search for WLAN networks with your device.
 - Select the SSID of the inverter **SMA[serial number]** in the list with the found WLAN networks.
 - Enter the inverter WLAN password. Within the first 10 operating hours, you must use the standard WLAN password **SMA12345**. After the first 10 operating hours, you must use the device-specific WLAN password (WPA2-PSK) of the inverter. The WLAN password (WPA2-PSK) is printed on the type label.
3. Enter the IP address **192.168.12.3** or, if your device supports mDNS services, **SMA[serial number].local** in the address line of the web browser and press the enter key.
4.  **Web browser signals a security vulnerability**

After the IP address has been confirmed by pressing the enter key, a message might appear indicating that the connection to the user interface of the inverter is not secure. SMA Solar Technology AG guarantees that calling up the user interface is secure.

 - Continue loading the user interface.
 - The login page of the user interface opens.

8.1.2 Establishing a Connection via Ethernet in the local network

i New IP address for connecting with a local network

If the inverter is connected to a local network via a network cable (e.g. via a router), the inverter will receive a new IP address. Depending on the type of configuration, the new IP address will be assigned automatically by the DHCP server (router) or manually by you. Upon completion of the configuration, the inverter is only reachable via this new IP address or the alternative addresses.

Access addresses of the inverter:

- Generally applicable access address, e.g. for android products: IP address manually assigned or assigned by the DHCP server (router) (identification via SMA Connection Assist, network scanner software or router manual).
- Alternative access address for Apple products: SMA[serial number].local (e.g. SMA2130019815.local)
- Alternative access address for certain Windows products: SMA[serial number] (e.g. SMA2130019815)

Requirements:

- The inverter must be connected to the local network via a network cable (e.g. via a router).
- The inverter must be integrated in the local network.
- A computer, tablet PC or smartphone must be available and the computer, tablet PC or smartphone must be connected with the network to which the inverter is also connected.
- In the case of a computer connection, one of the following web browsers must be installed: Firefox (as of version 25), Internet Explorer (as of version 10), Safari (as of version 7), Opera (as of version 17) or Google Chrome (as of version 30).
- In the case of a tablet PC or smartphone connection, one of the following web browsers must be installed: Firefox (as of version 25), Safari (as of version iOS 7) or Google Chrome (as of version 29).
- The personal SMA Grid Guard code of the Installer must be available for the changing of grid-relevant settings after completion of the first ten feed-in hours (see certificate "Application for SMA Grid Guard Code" at www.SMA-Solar.com).

Procedure:

1. Open the web browser of your device, enter the IP address of the inverter in the address line of the web browser and press the enter key.
 2. **i** **Web browser signals a security vulnerability**

After the IP address has been confirmed by pressing the enter key, a message might appear indicating that the connection to the user interface of the inverter is not secure. SMA Solar Technology AG guarantees that calling up the user interface is secure.

 - Continue loading the user interface.
- The login page of the user interface opens.

8.2 Logging In and Out of the User Interface

After a connection to the user interface of the inverter has been established, the login page opens. Log onto the user interface as described below.

Usage of cookies

For the correct display of the user interface, cookies are required. The cookies are used for convenience only. By using this user interface you agree to the placement of cookies.

Log in as installer or user for the first time

Password for PV systems that are registered in a communication product

The password for the user group **Installer** is also the system password. If you assign a password for the user group **Installer** via the user interface of the inverter, the password must match the PV system password. If the new password for logging onto the user interface does not match the system password in the communication product, the inverter cannot be reached by the communication product.

- A uniform password is assigned for all Speedwire devices in the PV system.

Procedure:

1. In the drop-down list **Language**, select the desired language.
 2. In the **User group** drop-down list, select the entry **Installer** or **User**.
 3. In the **New password** field, enter a new password for the selected user group.
 4. In the **Repeat password** field, enter the new password again.
 5. Select **Login**.
- The **Configuring the Inverter** page or the user interface start page opens.

Log in as the User or Installer

1. In the drop-down list **Language**, select the desired language.
 2. In the **User group** drop-down list, select the entry **Installer** or **User**.
 3. Enter the password in the field **Password**.
 4. Select **Login**.
- The start page of the user interface opens.

Log Out as the User or Installer

1. On the right-hand side of the menu bar, select the menu **User Settings**.
 2. In the subsequent context menu, select [**Logout**].
- The login page of the user interface opens. The logout was successful.

8.3 Start Page Design of the User Interface

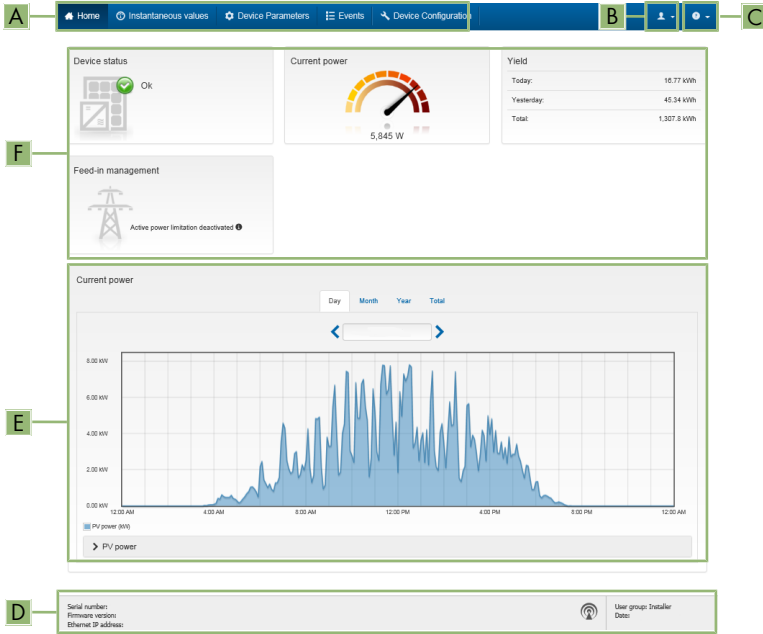

Figure 14: Start page design of the user interface (example)

Position	Designation	Description
A	Menu	<p>Provides the following functions:</p> <ul style="list-style-type: none"> • Home Opens the user interface homepage • Instantaneous values Current measured values of the inverter • Device Parameters The various operating parameters of the inverter can be viewed and configured here depending on the user group. • Events All events that have occurred in the selected time period are displayed here. The event types are Information, Warning and Error. Currently existing events of the types Error and Warning will be additionally displayed in the Device status viewlet. However, only the higher-priority event is displayed. If, for example, there is a Warning and an Error present at the same time, only the Error will be displayed. • System Configuration The following settings for the inverter can be performed here. The selection available is dependent on which user group you are logged in as and the operating system of the device with which the user interface has been called up. <ul style="list-style-type: none"> - Changing device names - Updating firmware (not available with devices having an iOS operating system) - Saving a configuration to file (not available with devices having an iOS operating system) - Loading a configuration from a file (not available with devices having an iOS operating system) - Importing a proxy certificate (not available with devices having an iOS operating system)

Position	Designation	Description
B	User settings	Provides the following functions, depending on the user group logged in: <ul style="list-style-type: none">• Starting the installation assistant• SMA Grid Guard login• Logout
C	Help	Provides the following functions: <ul style="list-style-type: none">• Displaying information on Open Source licenses used• Link to the website of SMA Solar Technology AG
D	Status bar	Displays the following information: <ul style="list-style-type: none">• Inverter serial number• Inverter firmware version• IP address of the inverter within the local network and/or IP address of the inverter during WLAN connection• User group logged in• Date and device time of the inverter

Position	Designation	Description
E	Current power and current consumption	Temporal progression of the PV power and the power consumption of the household over the selected time period. Please note, the power consumption will only be displayed if an energy meter is installed in the PV system.
F	Status display	<p>The various areas display information on the current status of the PV system.</p> <ul style="list-style-type: none"> • Device status Displays whether the inverter is currently in a fault-free operating state or whether there is an event type Error or Warning present. • Current power Displays the power currently being generated by the inverter. • Current consumption Displays the current consumption of the household if an energy meter is installed in the PV system. • Yield Displays the energy yield of the inverter. • Consumption Displays the energy consumption of the household if an energy meter is installed in the PV system. • Feed-in management Displays whether the inverter is currently limiting its active power. • Irradiation / wind speed Depending on the connected sensors, displays the current solar irradiation or wind speed. • Temperature measurement Depending on the connected sensors, displays the current temperature of the PV modules and/or the ambient temperature.

8.4 Changing the Password

The password for the inverter can be changed for both user groups. Furthermore, the user group **Installer** can change the password for the user group **User** as well as its own password.

PV systems registered in a communication product

With PV systems that are registered in a communication product (e.g. Sunny Portal, Cluster Controller), you can also assign a new password for the user group **Installer** via the communication product. The password for the user group **Installer** is also the system password. If you assign a password for the user group **Installer** via the user interface of the inverter that does not correspond to the system password in the communication product, the inverter can no longer be reached by the communication product.

- Ensure that the password for the user group **Installer** is the same as the system password in the communication product.

Procedure:

1. Activate the user interface (see Section 8.1, page 49).
2. Log into the user interface (see Section 8.2, page 52).
3. Call up the menu **Device Parameters**.
4. Select [**Edit parameters**].
5. In the parameter group **User Rights > Access Control** change the password of the desired user group.
6. Select [**Save all**] to save the changes.

9 Configuration of the Inverter

9.1 Changing Operating Parameters

The operating parameters of the inverter are set to certain values by default. You can change the operating parameters to optimize the performance of the inverter.

This section describes the basic procedure for changing operating parameters. Always change operating parameters as described in this section. Some function-sensitive parameters can only be viewed by qualified persons and can only be changed by qualified persons by entering the personal SMA Grid Guard code.

Requirements:

- The changes to the grid-relevant parameters must be approved by the grid operator.
- When changing grid-relevant parameters, the SMA Grid Guard code must be available (see "Application for SMA Grid Guard Code" at www.SMA-Solar.com).

Procedure:

1. Activate the user interface (see Section 8.1, page 49).
 2. Log into the user interface (see Section 8.2, page 52).
 3. Call up the menu **Device Parameters**.
 4. Select [**Edit parameters**].
 5. Log in using the SMA Grid Guard code to change those parameters designated by a lock (only for installers):
 - Select the menu **User Settings** (see Section 8.3, page 53).
 - In the subsequent context menu, select [**SMA Grid Guard login**].
 - Enter the SMA Grid Guard code and select [**Login**].
 6. Expand the parameter group that contains the parameter which is to be configured.
 7. Change the desired parameters.
 8. Select [**Save all**] to save the changes.
- The inverter parameters are set.

Accepting the settings

Saving the made settings is indicated by an hourglass symbol on the user interface. If the DC voltage is sufficient, the data is transferred directly to the inverter and accepted. If the DC voltage is too low (e. g. in the evening), the settings are saved, but they cannot be directly transferred to or accepted by the inverter. As long as the inverter has not yet received and accepted the settings, the hourglass symbol will continue to be displayed on the user interface. The settings will be accepted when there is sufficient DC voltage applied and the inverter restarts. As soon as the hourglass symbol appears on the user interface, the settings have been saved. The settings will not be lost. You can log off of the user interface and leave the system.

9.2 Starting the Installation Assistant

⚠ QUALIFIED PERSON

The installation assistant leads you step-by-step through the steps necessary for the initial configuration of the inverter.

Layout of the installation assistant

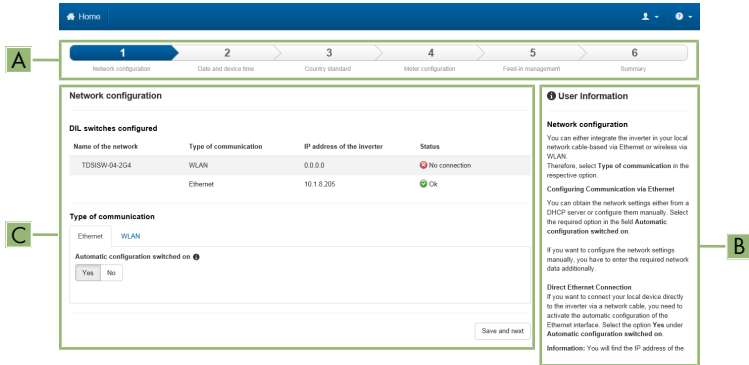

Figure 15: Layout of the installation assistant (example)

Position	Designation	Description
A	Configuration steps	Overview of the installation assistant steps. The number of steps depends on the type of device and the additionally installed modules. The current step is highlighted in blue.
B	User information	Information about the current configuration step and the setting options of the configuration step.
C	Configuration field	You can make settings in this field.

Requirement:

- When configuring after completion of the first ten operating hours, the SMA Grid Guard code must be available in order to change the grid-relevant parameters (see "Application for SMA Grid Guard Code" at www.SMA-Solar.com). A charge is levied for this code.

Procedure:

1. Activate the user interface (see Section 8.1, page 49).
 2. Log in as **Installer**.
 3. Select the menu **User Settings** (see Section 8.3, page 53) on the start page of the user interface.
 4. In the context menu, select [**Start the installation assistant**].
- The installation assistant will open.

9.3 Configuring the Country Data Set

⚠ QUALIFIED PERSON

By default, the inverter is set to a universally valid country data set. You can adjust the country data set for the installation site retroactively.

The basic procedure for changing operating parameters is explained in another section (see Section 9.1 "Changing Operating Parameters", page 58).

Procedure:

- In the parameter group **Grid monitoring > Grid monitoring** select the parameter **Set country standard** and set the required country data set.

9.4 Changing the Operating Mode of the Multifunction Relay

⚠ QUALIFIED PERSON

The default operating mode of the multifunction relay is **Fault indication (FltInd)**. If you decide to use another operating mode and have established the correct electrical connection for this operating mode and the associated connection variant, you will have to change the operating mode of the multifunction relay and make other settings, if necessary.

The basic procedure for changing operating parameters is explained in another section (see Section 9.1 "Changing Operating Parameters", page 58).

Procedure:

1. Select the parameter **Operating mode of multifunction relay** or **Mlt.OpMode** and set the desired operating mode.
2. Once you have set the operating mode **Self-consumption** or **SelfCsmP**, you can configure other settings:
 - Select the parameter **Minimum On power for MFR self-consumption** or **Mlt.MinOnPwr** and set the desired value. This will configure the power threshold from which a load is to be activated.
 - Select the parameter **Minimum power On time, MFR self-consumption** or **Mlt.MinOnPwrTmm** and set the desired value. This will configure the minimum time for which the power must have exceeded the minimum switch-on power threshold in order to trip activation of the load.
 - Select the parameter **Minimum On time for MFR self-consumption** or **Mlt.MinOnTmm** and set the desired value. This will configure the minimum time for which the load remains activated.
3. If you have set the operating mode **Control via communication** or **ComCtl**, select the parameter **Status of MFR with control via communication** or **Mlt.ComCtl.Sw** and set the desired value. This will configure the status at which the multifunction relay is controlled via a communication product.
4. If you have set the operating mode **Battery bank** or **BatCha**, make further settings:

- Select the parameter **Minimum On power for MFR battery bank** or **Mlt.BatCha.Pwr** and set the desired value. This will configure the power threshold from which the battery is to be charged.
- Select the parameter **Minimum time before reconnection of MFR battery bank** or **Mlt.BatCha.Tmm** and set the desired value. This will configure the minimum time which must elapse after charging the battery before the battery can be charged again.

9.5 Configuring the Modbus Function

QUALIFIED PERSON

The Modbus interface is deactivated by default and the communication ports 502 set. In order to access SMA inverters with SMA Modbus® or SunSpec® Modbus®, the Modbus interface must be activated. After activating the interface, the communication ports of both IP protocols can be changed.

For information on commissioning and configuration of the Modbus interface, see the Technical Information "SMA Modbus® Interface" or in the Technical Information "SunSpec® Modbus® Interface" at www.SMA-Solar.com.

Data security during activated Modbus interface

If you activate the Modbus interface, there is a risk that unauthorized users may access and manipulate the data or devices in your PV system.

- Take appropriate protective measures such as:
 - Set up a firewall.
 - Close unnecessary network ports.
 - Only enable remote access via VPN tunnel.
 - Do not set up port forwarding at the communication port in use.
 - In order to deactivate the Modbus interface, reset the inverter to default settings or deactivate the activated parameter again.

Procedure:

- Activate the Modbus interface and adjust the communication ports if necessary (see the Technical Information "SMA Modbus® Interface" or "SunSpec® Modbus® Interface" at www.SMA-Solar.com).

9.6 Setting the Tripping Threshold of the Residual-Current Device

QUALIFIED PERSON

If a residual-current device with a tripping threshold of < 500 mA is used, you must change the tripping threshold in the inverter accordingly. For further information, see the Technical Information "Leading Leakage Currents" at www.SMA-Solar.com.

The basic procedure for changing operating parameters is explained in another section (see Section 9.1 "Changing Operating Parameters", page 58).

- Select the **RCD adjustment** parameter and set it to the tripping threshold of the residual-current device that is used.

9.7 Configuring Feed-In Management

QUALIFIED PERSON

If required by the grid operator, the inverter can provide grid management services. You can configure these via the inverter feed-in management. Coordinate the configuration of the feed-in management with your grid operator beforehand.

The basic procedure for changing operating parameters is explained in another section (see Section 9.1 "Changing Operating Parameters", page 58).

Procedure:

1. Activate the user interface (see Section 8.1, page 49).
2. Log into the user interface as an **Installer**.
3. On the right-hand side of the menu bar, select the menu **User Settings** (see Section 8.3 "Start Page Design of the User Interface", page 53).
4. In the context menu, select [**Starting the installation assistant**].
5. Select [**Save and next**] until you reach the **Feed-in management** step.
6. Configure the feed-in management as desired.

9.8 Setting SMA OptiTrac Global Peak

QUALIFIED PERSON

For partially shaded PV modules, you should set the interval at which the inverter is to optimize the MPP of the PV system. If you do not want to use SMA OptiTrac Global Peak feature, you can deactivate the feature.

The basic procedure for changing operating parameters is explained in another section (see Section 9.1 "Changing Operating Parameters", page 58).

Procedure:

- In the parameter group **DC-side > DC settings > OptiTrac Global Peak**, set the parameter **Cycle time of the OptiTrac Global Peak algorithm** and set the required time interval. The ideal time interval is usually six minutes. This value should only be increased if the shading situation changes extremely slowly.
 - The inverter optimizes the MPP of the PV system at the predetermined time interval.
- In order to deactivate the SMA OptiTrac Global Peak feature, in the parameter group **DC-side > DC settings > OptiTrac Global Peak**, set the parameter **OptiTrac Global Peak switched on** to **Off**.

9.9 Activating the Receipt of Control Signals (Only for Italy)

QUALIFIED PERSON

In order for PV systems in Italy to receive control commands from the grid operator, set the following parameters.

The basic procedure for changing operating parameters is explained in another section (see Section 9.1 "Changing Operating Parameters", page 58).

Parameter	Value/range	Resolution	Default
Application ID	0 to 16384	1	16384
GOOSE-Mac address	01:0C:CD:01:00:00 to 01:0C:CD:01:02:00	1	01:0C:CD:01:00:00

Procedure:

1. Select the parameter group **External communication > IEC 61850 configuration**.
2. In the field **Application ID**, enter the application ID of the grid operator gateway. You will receive this value from your grid operator. You can enter a value between 0 and 16384. The value 16384 indicates "deactivated".
3. In the field **GOOSE-Mac address**, enter the MAC address of the grid operator gateway from which the inverter is to receive the control commands. You will receive this value from your grid operator.
 - The receipt of control signals from the grid operator is activated.

9.10 Activating String-Failure Detection

QUALIFIED PERSON

1. Activate the user interface (see Section 8.1, page 49).
2. Log into the user interface as an **Installer**.
3. On the right-hand side of the menu bar, select the menu **User Settings** (see Section 8.3 "Start Page Design of the User Interface", page 53).

4. In the context menu, select [**Starting the installation assistant**].
5. Select [**Save and next**] until you reach the **String configuration** step.
6. Activate string-failure detection and configure it as required.

9.11 Saving the Configuration in a File

You can save the current configuration of the inverter in a file. You can use this file as a data backup for this inverter and then import this file into this inverter again or another inverter to configure the inverter. When saving, only the device parameters will be saved, not any passwords.

Procedure:

1. Activate the user interface (see Section 8.1, page 49).
2. Log into the user interface (see Section 8.2, page 52).
3. Select the menu **Device Configuration**.
4. Select [**Settings**].
5. In the context menu, select [**Saving the configuration in a file**].
6. Follow the instructions in the dialog.

9.12 Adopting a Configuration from a File

QUALIFIED PERSON

To configure the inverter, you can adopt the configuration from a file. To be able to do this, you must first save the configuration of another inverter in a file (see Section 9.11 "Saving the Configuration in a File", page 64). When saving, only the device parameters will be adopted, not any passwords.

Requirements:

- The SMA Grid Guard code must be available (see "Application for SMA Grid Guard Code" at www.SMA-Solar.com). A charge is levied for this code.
- Changes to grid-relevant parameters must be approved by the responsible grid operator.

Procedure:

1. Activate the user interface (see Section 8.1, page 49).
2. Log into the user interface as an **Installer**.
3. Select the menu **Device Configuration**.
4. Select [**Settings**].
5. In the context menu, select [**Adopting the configuration from a file**].
6. Follow the instructions in the dialog.

9.13 Switching the Dynamic Power Display Off

As standard, the inverter signals its power dynamically via the pulsing of the green LED. When doing so, the LED flashes on and off uniformly or is permanently lit at full power. The various gradations are related here to the set active power limit of the inverter. If this display is not desired, switch this function off in accordance with the following procedure. Once this has been done, the green LED is lit permanently to signalize feed-in operation.

The basic procedure for changing operating parameters is explained in another section (see Section 9.1 "Changing Operating Parameters", page 58).

Procedure:

- In the parameter group **Device > Operation**, select the parameter **Dynamic power display via green LED** and set this to **Off**.

9.14 Switching WLAN On and Off

The inverter is equipped with an activated WLAN interface as standard. If you do not want to use WLAN, you can switch the WLAN function off and switch it on again whenever needed. In doing so, you can switch the WLAN direct connection and the WLAN connection in the local network on independently of each other.

Switching on the WLAN function only possible via Ethernet connection

If you switch off both the WLAN function for the direct connection and for the connection in the local network, access to the inverter user interface and therefore reactivation of the WLAN interface is only possible via an Ethernet connection.

The basic procedure for changing operating parameters is explained in another section (see Section 9.1 "Changing Operating Parameters", page 58).

Switching WLAN Off

If you would like to switch the WLAN function off completely, you must switch off both the direct connection and the connection in the local network.

Procedure:

- To switch off the direct connection in the parameter group **PV system communication > WLAN**, select the parameter **Soft-access-point is turned on** and set this to **No**.
- To switch off the connection in the local network in the parameter group **PV system communication > WLAN**, select the parameter **WLAN is turned on** and set this to **No**.

Switching WLAN On

If you have switched the WLAN function for direct connection or for connection in the local network off, you can switch the WLAN function back on in accordance with the following procedure.

Requirement:

- If the WLAN function was previously switched off completely, the inverter must be connected to a computer or router via Ethernet.

Procedure:

- To switch on the WLAN direct connection, in the parameter group **PV system communication > WLAN**, select the parameter **Soft-access-point is turned on** and set this to **Yes**.
- To switch on the WLAN connection in the local network, in the parameter group **System communication > WLAN**, select the parameter **WLAN is turned on** and set this to **Yes**.

9.15 Activate WPS Function

- Activate the WPS function on the inverter. To do this, tap twice in succession on the enclosure lid of the DC connection unit next to the LEDs.
 - The blue LED flashes quickly for approx. two minutes. The WPS function is active.

10 Disconnecting the Inverter from Voltage Sources

⚠ QUALIFIED PERSON

Prior to performing any work on the inverter, always disconnect it from all voltage sources as described in this section. Always adhere to the prescribed sequence.

NOTICE

Destruction of the measuring device due to overvoltage

- Only use measuring devices with a DC input voltage range of 1000 V or higher.

Procedure:

1. Disconnect the AC circuit breaker and secure it against reconnection.
2. Set the DC load-break switch of the inverter to position **O**.

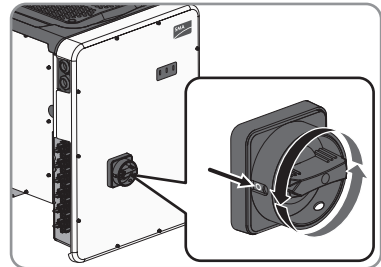

3. Secure the DC load-break switch against reconnection using a suitable padlock.

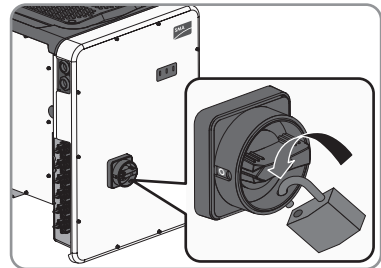

4. If the multifunction relay is used, switch off any supply voltage to the load.
5. Wait until the LEDs have gone out.
6. Use a current clamp to ensure that no current is present in the DC cables.

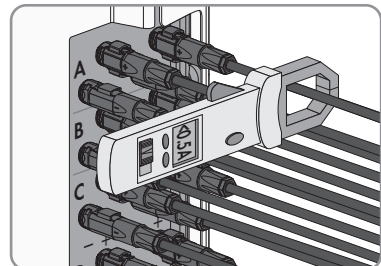

7. Release and remove the DC connectors. To do this, insert a flat-blade screwdriver or an angled screwdriver (blade width: 3.5 mm) into one of the slide slots and pull the DC connectors out in a downward direction. Do not pull on the cable.

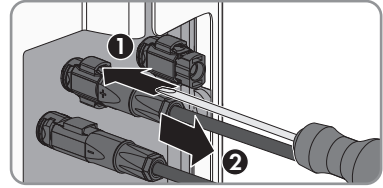

8. Ensure that no voltage is present at the DC inputs on the inverter using a suitable measuring device.

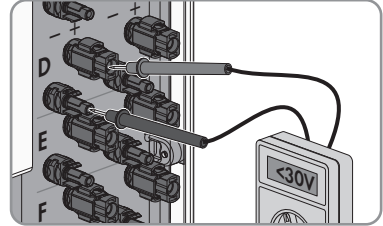

9. Unscrew all ten screws of the enclosure lid of the AC connection unit using a Torx screwdriver (TX 25) and remove the enclosure lid towards the front.

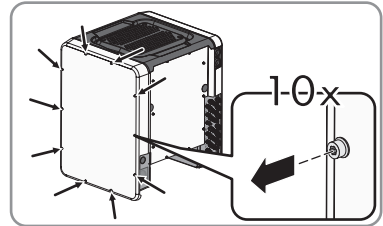

10. Set the screws and the enclosure lid aside and store safely.

11. Ensure there is no voltage on the AC terminal block between L1 and N, L2 and N, and L3 and N using a suitable measuring device. To do so, insert the test probe (maximum diameter: 2.5 mm) into the measuring points of the respective terminal blocks.

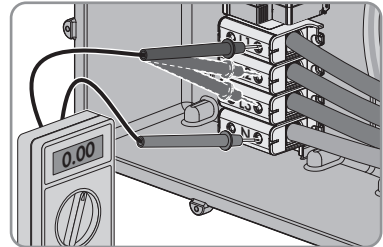

12. Ensure there is no voltage on the AC terminal block between L1 and PE, L2 and PE, and L3 and PE using a suitable measuring device. To do so, insert the test probe (maximum diameter: 2.5 mm) into the measuring blocks.

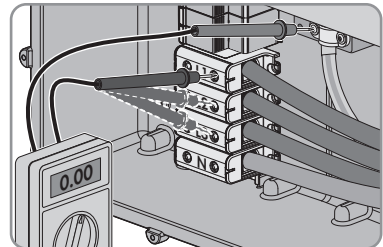

11 Cleaning the Inverter

NOTICE**Damage to the type label due to the use of cleaning agents**

- If the inverter is dirty, clean the enclosure, the enclosure lid, the type label and the LEDs with a damp cloth and clear water only.

12 Troubleshooting

12.1 Event Messages

Event number	Message, cause and corrective measures
101	<p data-bbox="311 304 583 336">⚠ QUALIFIED PERSON</p> <p data-bbox="292 352 389 381">Grid fault</p> <p data-bbox="292 389 981 445">The grid voltage or grid impedance at the connection point of the inverter is too high. The inverter has disconnected from the utility grid.</p> <p data-bbox="292 453 508 481">Corrective measures:</p> <ul data-bbox="311 489 986 545" style="list-style-type: none"> • Check whether the grid voltage at the connection point of the inverter is permanently in the permissible range. <p data-bbox="334 553 992 671">If the grid voltage is outside the permissible range due to local grid conditions, contact the grid operator. The grid operator must agree with an adjustment of the voltage at the feed-in point or with a change of the monitored operating limits.</p> <p data-bbox="334 679 997 762">If the grid voltage is permanently within the permissible range and this message is still displayed, contact the Service (see Section 16 "Contact", page 101).</p>
301	<p data-bbox="311 780 583 812">⚠ QUALIFIED PERSON</p> <p data-bbox="292 828 389 857">Grid fault</p> <p data-bbox="292 865 992 983">The ten-minute average value of the grid voltage is no longer within the permissible range. The grid voltage or grid impedance at the connection point is too high. The inverter disconnects from the utility grid to maintain power quality.</p> <p data-bbox="292 991 508 1019">Corrective measures:</p> <ul data-bbox="311 1027 986 1083" style="list-style-type: none"> • During the feed-in operation, check whether the grid voltage at the connection point of the inverter is permanently in the permissible range. <p data-bbox="334 1091 992 1209">If the grid voltage is outside the permissible range due to local grid conditions, contact the grid operator. The grid operator must agree with an adjustment of the voltage at the feed-in point or with a change of the monitored operating limits.</p> <p data-bbox="334 1217 997 1300">If the grid voltage is permanently within the permissible range and this message is still displayed, contact the Service (see Section 16 "Contact", page 101).</p>

Event number	Message, cause and corrective measures
401	<p data-bbox="311 185 596 220">⚠ QUALIFIED PERSON</p> <p data-bbox="288 236 393 260">Grid fault</p> <p data-bbox="288 272 1012 328">The inverter has disconnected from the utility grid. A stand-alone grid or a very large change in the power frequency was detected.</p> <p data-bbox="288 336 508 360">Corrective measures:</p> <ul data-bbox="311 368 1012 392" style="list-style-type: none"> • Check the grid connection for significant short-term frequency fluctuations.
501	<p data-bbox="311 408 596 443">⚠ QUALIFIED PERSON</p> <p data-bbox="288 459 393 483">Grid fault</p> <p data-bbox="288 496 992 552">The power frequency is not within the permissible range. The inverter has disconnected from the utility grid.</p> <p data-bbox="288 560 508 584">Corrective measures:</p> <ul data-bbox="311 592 908 647" style="list-style-type: none"> • If possible, check the power frequency and observe how often fluctuations occur. <p data-bbox="333 663 997 743">If fluctuations occur frequently and this message is displayed often, contact the grid operator and request approval to change the operating parameters of the inverter.</p> <p data-bbox="333 759 938 839">If the grid operator gives his approval, discuss any changes to the operating parameters with Service (see Section 16 "Contact", page 101).</p>
601	<p data-bbox="311 850 596 885">⚠ QUALIFIED PERSON</p> <p data-bbox="288 901 393 925">Grid fault</p> <p data-bbox="288 938 978 994">The inverter has detected an excessively high proportion of direct current in the grid current.</p> <p data-bbox="288 1002 508 1026">Corrective measures:</p> <ul data-bbox="311 1034 969 1129" style="list-style-type: none"> • Check the grid connection for direct current. • If this message is displayed frequently, contact the grid operator and check whether the monitoring threshold on the inverter can be raised.

Event number	Message, cause and corrective measures
801	<p data-bbox="311 183 593 215">⚠ QUALIFIED PERSON</p> <p data-bbox="288 231 957 263">Waiting for grid voltage > Grid failure > Check AC circuit breaker</p> <p data-bbox="288 271 1002 327">The AC cable is not correctly connected or the country data set is not correctly configured.</p> <p data-bbox="288 335 509 359">Corrective measures:</p> <ul data-bbox="311 367 991 574" style="list-style-type: none"> <li data-bbox="311 367 778 391">• Make sure that the circuit breaker is switched on. <li data-bbox="311 406 929 462">• Ensure that the AC cable is not damaged and that it is connected correctly. <li data-bbox="311 478 907 502">• Ensure that the country data set has been configured correctly. <li data-bbox="311 518 991 574">• Check whether the grid voltage at the connection point of the inverter is permanently in the permissible range. <p data-bbox="333 582 991 694">If the grid voltage is outside the permissible range due to local grid conditions, contact the grid operator. The grid operator must agree with an adjustment of the voltage at the feed-in point or with a change of the monitored operating limits.</p> <p data-bbox="333 702 996 790">If the grid voltage is permanently within the permissible range and this message is still displayed, contact the Service (see Section 16 "Contact", page 101).</p>
901	<p data-bbox="311 805 593 837">⚠ QUALIFIED PERSON</p> <p data-bbox="288 853 666 885">PE conn. missing > Check connection</p> <p data-bbox="288 893 767 917">The grounding conductor is not correctly connected.</p> <p data-bbox="288 925 509 949">Corrective measures:</p> <ul data-bbox="311 957 879 989" style="list-style-type: none"> <li data-bbox="311 957 879 989">• Ensure that the grounding conductor is correctly connected.

Event number	Message, cause and corrective measures
3401 to 3407	<p data-bbox="311 185 596 220">⚠ QUALIFIED PERSON</p> <p data-bbox="288 236 695 263">DC overvoltage > Disconnect generator</p> <p data-bbox="288 272 820 300">Overvoltage at the DC input. This can destroy the inverter.</p> <p data-bbox="288 308 917 335">This message is signaled additionally by rapid flashing of the LEDs.</p> <p data-bbox="288 343 508 370">Corrective measures:</p> <ul data-bbox="311 378 997 691" style="list-style-type: none"> <li data-bbox="311 378 941 432">• Immediately disconnect the inverter from all voltage sources (see Section 10, page 67). <li data-bbox="311 443 997 528">• Check whether the DC voltage is below the maximum input voltage of the inverter. If the DC voltage is below the maximum input voltage of the inverter, reconnect the DC connectors to the inverter. <li data-bbox="311 539 992 624">• If the DC voltage exceeds the maximum input voltage of the inverter, ensure that the PV array has been correctly rated or contact the installer of the PV array. <li data-bbox="311 635 902 691">• If this message is repeated frequently, contact the Service (see Section 16 "Contact", page 101).
3501	<p data-bbox="311 707 596 742">⚠ QUALIFIED PERSON</p> <p data-bbox="288 758 659 785">Insulation failure > Check generator</p> <p data-bbox="288 794 801 821">The inverter has detected a ground fault in the PV array.</p> <p data-bbox="288 829 508 857">Corrective measures:</p> <ul data-bbox="311 865 953 892" style="list-style-type: none"> <li data-bbox="311 865 953 892">• Check the PV system for ground faults (see Section 12.4, page 87).
3701	<p data-bbox="311 903 596 938">⚠ QUALIFIED PERSON</p> <p data-bbox="288 954 678 981">Resid.curr.too.high > Check generator</p> <p data-bbox="288 991 1009 1046">The inverter has detected a residual current due to temporary grounding of the PV array.</p> <p data-bbox="288 1054 508 1082">Corrective measures:</p> <ul data-bbox="311 1090 953 1117" style="list-style-type: none"> <li data-bbox="311 1090 953 1117">• Check the PV system for ground faults (see Section 12.4, page 87).
3801 to 3805	<p data-bbox="311 1131 596 1166">⚠ QUALIFIED PERSON</p> <p data-bbox="288 1182 642 1209">DC overcurrent > Check generator</p> <p data-bbox="288 1219 981 1246">Overcurrent at the DC input. The inverter briefly interrupts feed-in operation.</p> <p data-bbox="288 1254 508 1281">Corrective measures:</p> <ul data-bbox="311 1289 1003 1342" style="list-style-type: none"> <li data-bbox="311 1289 1003 1342">• If this message is displayed frequently, ensure that the PV array has been correctly rated and wired.

Event number	Message, cause and corrective measures
6002 to 6412	<p data-bbox="311 183 593 215">⚠ QUALIFIED PERSON</p> <p data-bbox="288 231 655 263">Self diagnosis > Interference device</p> <p data-bbox="288 268 711 300">The cause must be determined by the Service.</p> <p data-bbox="288 304 509 336">Corrective measures:</p> <ul data-bbox="311 341 879 373" style="list-style-type: none"> • Contact the Service (see Section 16 "Contact", page 101).
6502	<p data-bbox="311 383 593 414">⚠ QUALIFIED PERSON</p> <p data-bbox="288 430 638 462">Self-diagnosis > Overtemperature</p> <p data-bbox="288 467 828 499">The inverter has switched off due to excessive temperature.</p> <p data-bbox="288 504 509 536">Corrective measures:</p> <ul data-bbox="311 541 980 710" style="list-style-type: none"> • Clean the cooling fins on the rear of the enclosure and the air ducts on the top using a soft brush. • Ensure that the inverter has sufficient ventilation. • Ensure that the ambient temperature +35°C has not been exceeded. • Ensure that the inverter is not exposed to direct solar irradiation.
6512	<p data-bbox="288 726 756 758">Minimum operating temperature not reached</p> <p data-bbox="288 762 952 813">The inverter will only recommence grid feed-in once the temperature has reached at least -25°C.</p>
6603 to 6604	<p data-bbox="311 829 593 861">⚠ QUALIFIED PERSON</p> <p data-bbox="288 877 560 909">Self-diagnosis > Overload</p> <p data-bbox="288 914 711 946">The cause must be determined by the Service.</p> <p data-bbox="288 951 509 983">Corrective measures:</p> <ul data-bbox="311 987 879 1019" style="list-style-type: none"> • Contact the Service (see Section 16 "Contact", page 101).
6701 to 6702	<p data-bbox="311 1021 593 1053">⚠ QUALIFIED PERSON</p> <p data-bbox="288 1069 554 1101">Communication disturbed</p> <p data-bbox="288 1106 991 1173">Error in the communication processor, the inverter continues feeding in, however. The cause must be determined by the Service.</p> <p data-bbox="288 1177 509 1209">Corrective measures:</p> <ul data-bbox="311 1214 912 1265" style="list-style-type: none"> • If this message is displayed frequently, contact the Service (see Section 16 "Contact", page 101).

Event number	Message, cause and corrective measures
7101	<p>⚠ QUALIFIED PERSON</p> <p>SD card defective The SD memory card is not formatted.</p> <p>Corrective measures:</p> <ul style="list-style-type: none"> • Re-format the SD memory card. • Re-save the files to the SD memory card.
7102	<p>⚠ QUALIFIED PERSON</p> <p>Parameter file not found or defective The parameter file was not found or is defective. The update failed. The inverter continues feeding power into the grid.</p> <p>Corrective measures:</p> <ul style="list-style-type: none"> • Copy the parameter file to the correct folder again.
7105	<p>⚠ QUALIFIED PERSON</p> <p>Param. setting failed Parameters could not be set using the memory card. The inverter continues feeding power into the grid.</p> <p>Corrective measures:</p> <ul style="list-style-type: none"> • Ensure that the parameters are set correctly. • Ensure that the SMA Grid Guard code is available.
7106	<p>Update file defect. The update file is defective. The update failed. The inverter continues feeding power into the grid.</p>
7110	<p>No update file found No new update file was found on the SD memory card. The update failed. The inverter continues feeding power into the grid.</p>
7112	<p>Update file successfully copied</p>
7113	<p>The memory card is full or write-protected</p>
7201 to 7202	<p>Data storage not possible</p>
7303	<p>⚠ QUALIFIED PERSON</p> <p>Update main CPU failed The cause must be determined by the Service.</p> <p>Corrective measures:</p> <ul style="list-style-type: none"> • Contact the Service (see Section 16 "Contact", page 101).

Event number	Message, cause and corrective measures
7320	<p>The device with serial number [xx] was successfully updated to firmware version [xxx].</p> <p>The firmware update was completed successfully.</p>
7330	<p>Condition test failed</p> <p>The testing of the update conditions was successful. The firmware update package is suitable for this inverter.</p>
7331	<p>Update transport started</p> <p>Update file is being copied.</p>
7332	<p>Update transport successful</p> <p>Update file was copied successfully to the inverter's internal memory.</p>
7333	<p>⚠ QUALIFIED PERSON</p> <p>Update transport failed</p> <p>Update file could not be copied to the inverter's internal memory. In the event of connection with the inverter via WLAN, a poor connection quality can be the cause.</p> <p>Corrective measures:</p> <ul style="list-style-type: none"> • Retry update. • For WLAN connection: Improve the WLAN connection quality (e.g. via WLAN repeater) or establish connection with the inverter via Ethernet. • If this message is displayed again, contact the Service (see Section 16 "Contact", page 101).
7341	<p>Update Bootloader</p> <p>The inverter is performing a bootloader update.</p>
7342	<p>⚠ QUALIFIED PERSON</p> <p>Update Bootloader failed</p> <p>The bootloader update failed.</p> <p>Corrective measures:</p> <ul style="list-style-type: none"> • Retry update. • If this message is displayed again, contact the Service (see Section 16 "Contact", page 101).

Event number	Message, cause and corrective measures
7347	<p data-bbox="311 188 595 220">⚠ QUALIFIED PERSON</p> <p data-bbox="288 236 463 261">Incompatible file</p> <p data-bbox="288 271 759 296">The configuration file is not suitable for this inverter.</p> <p data-bbox="288 306 508 331">Corrective measures:</p> <ul data-bbox="311 341 952 405" style="list-style-type: none"> <li data-bbox="311 341 952 367">• Ensure that the selected configuration file is suitable for this inverter. <li data-bbox="311 376 452 405">• Retry import.
7348	<p data-bbox="311 424 595 456">⚠ QUALIFIED PERSON</p> <p data-bbox="288 472 495 497">Incorrect file format</p> <p data-bbox="288 507 887 533">The configuration file is not of the required format or is damaged.</p> <p data-bbox="288 542 508 568">Corrective measures:</p> <ul data-bbox="311 577 996 670" style="list-style-type: none"> <li data-bbox="311 577 996 632">• Ensure that the selected configuration file is of the required format and is not damaged. <li data-bbox="311 641 452 670">• Retry import.
7349	<p data-bbox="288 689 716 715">Incorrect login rights for configuration file</p> <p data-bbox="288 724 987 775">The user group logged in does not have the user rights necessary to be able to import a configuration.</p> <p data-bbox="288 785 508 810">Corrective measures:</p> <ul data-bbox="311 820 620 884" style="list-style-type: none"> <li data-bbox="311 820 508 845">• Log in as Installer. <li data-bbox="311 855 620 884">• Import configuration file again.
7350	<p data-bbox="288 903 721 928">Transfer of a configuration file has started</p> <p data-bbox="288 938 669 963">The configuration file is being transferred.</p>
7351	<p data-bbox="288 979 445 1005">Update WLAN</p> <p data-bbox="288 1015 687 1040">The inverter is updating the WLAN module.</p>
7352	<p data-bbox="288 1056 616 1082">Update of WLAN not successful</p> <p data-bbox="288 1091 658 1117">The update of the WLAN module failed.</p> <p data-bbox="288 1126 508 1152">Corrective measures:</p> <ul data-bbox="311 1161 978 1254" style="list-style-type: none"> <li data-bbox="311 1161 459 1187">• Retry update. <li data-bbox="311 1197 978 1254">• If this message is displayed again, contact the Service (see Section 16 "Contact", page 101).
7353	<p data-bbox="288 1270 580 1295">Update time zone database</p> <p data-bbox="288 1305 732 1331">The inverter is updating the time zone database.</p>

Event number	Message, cause and corrective measures
7354	<p>⚠ QUALIFIED PERSON</p> <p>Update of time zone database not successful The update of the time zone database failed.</p> <p>Corrective measures:</p> <ul style="list-style-type: none"> • Retry update. • If this message is displayed again, contact the Service (see Section 16 "Contact", page 101).
7355	<p>Update WebUI The inverter is updating the inverter user interface.</p>
7356	<p>⚠ QUALIFIED PERSON</p> <p>Update of the WebUI not successful The update of the inverter user interface failed.</p> <p>Corrective measures:</p> <ul style="list-style-type: none"> • Retry update. • If this message is displayed again, contact the Service (see Section 16 "Contact", page 101).
7500 to 7501	<p>⚠ QUALIFIED PERSON</p> <p>Fan fault > Check inverter electronic and fan</p>
7619	<p>⚠ QUALIFIED PERSON</p> <p>Communication fault with meter unit > Check communication to meter The inverter is not receiving any data from the energy meter.</p> <p>Corrective measures:</p> <ul style="list-style-type: none"> • Ensure that the energy meter is correctly integrated into the same network as the inverter (see energy meter manual). • For WLAN connection: Improve the WLAN connection quality (e.g. via WLAN repeater) or connect the inverter with the DHCP server (router) via Ethernet.
7702	<p>⚠ QUALIFIED PERSON</p> <p>Interference device The cause must be determined by the Service.</p> <p>Corrective measures:</p> <ul style="list-style-type: none"> • Contact the Service (see Section 16 "Contact", page 101).

Event number	Message, cause and corrective measures
8003	<p data-bbox="311 183 596 220">⚠ QUALIFIED PERSON</p> <p data-bbox="288 231 596 263">Active power limited derating</p> <p data-bbox="288 268 1005 327">The inverter has reduced its power output for more than ten minutes due to excessive temperature.</p> <p data-bbox="288 331 509 359">Corrective measures:</p> <ul data-bbox="311 363 983 542" style="list-style-type: none"> <li data-bbox="311 363 983 422">• Clean the cooling fins on the rear of the enclosure and the air ducts on the top using a soft brush. <li data-bbox="311 430 770 458">• Ensure that the inverter has sufficient ventilation. <li data-bbox="311 466 968 494">• Ensure that the ambient temperature +60°C has not been exceeded. <li data-bbox="311 502 918 542">• Ensure that the inverter is not exposed to direct solar irradiation.
8101 to 8104	<p data-bbox="311 558 596 595">⚠ QUALIFIED PERSON</p> <p data-bbox="288 606 554 633">Communication disturbed</p> <p data-bbox="288 638 711 665">The cause must be determined by the Service.</p> <p data-bbox="288 670 509 697">Corrective measures:</p> <ul data-bbox="311 702 873 742" style="list-style-type: none"> <li data-bbox="311 702 873 742">• Contact the Service (see Section 16 "Contact", page 101).
9002	<p data-bbox="311 750 596 786">⚠ QUALIFIED PERSON</p> <p data-bbox="288 798 599 825">SMA Grid Guard code invalid</p> <p data-bbox="288 829 1008 888">The SMA Grid Guard code entered is incorrect. The operating parameters are still protected and cannot be changed.</p> <p data-bbox="288 893 509 920">Corrective measures:</p> <ul data-bbox="311 925 711 965" style="list-style-type: none"> <li data-bbox="311 925 711 965">• Enter the correct SMA Grid Guard code.
9003	<p data-bbox="288 973 532 1000">Grid parameter locked</p> <p data-bbox="288 1005 1008 1093">Changes to the grid parameters are now blocked. In order to be able to make changes to the grid parameters, from now on you must log in using the SMA Grid Guard code.</p>
9005	<p data-bbox="311 1109 596 1145">⚠ QUALIFIED PERSON</p> <p data-bbox="288 1157 924 1184">Changing of grid parameters not possible > Ensure DC supply</p> <p data-bbox="288 1189 666 1216">This error can have the following causes:</p> <ul data-bbox="311 1220 957 1292" style="list-style-type: none"> <li data-bbox="311 1220 756 1248">• The parameters to be changed are protected. <li data-bbox="311 1252 957 1292">• The DC voltage at the DC input is not sufficient to run the main CPU. <p data-bbox="288 1300 509 1327">Corrective measures:</p> <ul data-bbox="311 1332 935 1436" style="list-style-type: none"> <li data-bbox="311 1332 644 1359">• Enter the SMA Grid Guard code. <li data-bbox="311 1364 935 1436">• Ensure that at least the DC start voltage is available (green LED is flashing, pulsing or glowing).

Event number	Message, cause and corrective measures
9007	<p>⚠ QUALIFIED PERSON</p> <p>Abort self-test The self-test (Italy only) was terminated.</p> <p>Corrective measures:</p> <ul style="list-style-type: none"> • Ensure that the AC connection is correct. • Restart the self-test.
10108	Time adjusted / old time
10109	Time adjusted / new time
10110	<p>⚠ QUALIFIED PERSON</p> <p>Time synchronization failed: [tn0] No time information could be called up from the set NTP server.</p> <p>Corrective measures:</p> <ul style="list-style-type: none"> • Ensure that the NTP server was configured correctly. • Ensure that the inverter is integrated into a local network with Internet connection.
10118	<p>Parameter upload complete The configuration file was loaded successfully.</p>
10248	<p>⚠ QUALIFIED PERSON</p> <p>[Interface]: network busy The network is busy. Data exchange between the devices is not at an optimum and is greatly delayed.</p> <p>Corrective measures:</p> <ul style="list-style-type: none"> • Increase the query intervals. • If necessary, reduce the number of devices in the network.
10249	<p>⚠ QUALIFIED PERSON</p> <p>[Interface]: network overloaded The network is overloaded. There is no data exchange between the devices.</p> <p>Corrective measures:</p> <ul style="list-style-type: none"> • Reduce the number of devices in the network. • If necessary, increase the data query intervals.

Event number	Message, cause and corrective measures
10250	<p data-bbox="311 188 595 220">⚠ QUALIFIED PERSON</p> <p data-bbox="288 236 722 263">[Interface]: package error rate [ok / high]</p> <p data-bbox="288 272 1005 355">The package error rate has changed. If the package error rate is high, the network is overloaded or the connection to the network switch or DHCP server (router) is disturbed.</p> <p data-bbox="288 365 837 392">Corrective measures if the package error rate is high:</p> <ul data-bbox="311 400 1009 560" style="list-style-type: none"> <li data-bbox="311 400 1009 483">• Ensure that with an Ethernet connection, the network cable and the network connector are not damaged and that the network connectors are correctly plugged. <li data-bbox="311 496 759 523">• If necessary, increase the data query intervals. <li data-bbox="311 536 865 563">• If necessary, reduce the number of devices in the network.
10251	<p data-bbox="288 576 968 632">[Interface]: communication status goes to [OK / Warning / Error / Not connected]</p> <p data-bbox="288 641 983 697">The communication status to the network switch or DHCP server (router) has changed. An additional error message may be displayed.</p>
10252	<p data-bbox="311 715 595 746">⚠ QUALIFIED PERSON</p> <p data-bbox="288 762 669 790">[Interface]: communication disrupted</p> <p data-bbox="288 799 685 826">There is no valid signal on the network line.</p> <p data-bbox="288 836 508 863">Corrective measures:</p> <ul data-bbox="311 871 1009 1021" style="list-style-type: none"> <li data-bbox="311 871 1009 954">• Ensure that with an Ethernet connection, the network cable and the network connector are not damaged and that the network connectors are correctly plugged. <li data-bbox="311 967 946 1021">• Ensure that the DHCP server (router) and any network switches are signaling correct operation.
10253	<p data-bbox="311 1034 595 1066">⚠ QUALIFIED PERSON</p> <p data-bbox="288 1082 890 1109">[Interface]: connection speed goes to [100 Mbit / 10 Mbit]</p> <p data-bbox="288 1118 1002 1201">The data transfer rate has changed. The cause for the status [10 Mbit] can be a defective plug, a defective cable or the pulling or plugging of the network connector.</p> <p data-bbox="288 1211 753 1238">Corrective measures if the status is [10 Mbit]:</p> <ul data-bbox="311 1246 1009 1399" style="list-style-type: none"> <li data-bbox="311 1246 1009 1329">• Ensure that with an Ethernet connection, the network cable and the network connector are not damaged and that the network connectors are correctly plugged. <li data-bbox="311 1342 946 1399">• Ensure that the DHCP server (router) and any network switches are signaling correct operation.

Event number	Message, cause and corrective measures
10254	<p data-bbox="311 183 599 215">⚠ QUALIFIED PERSON</p> <p data-bbox="288 231 756 263">[Interface]: duplex mode goes to [Full / Half]</p> <p data-bbox="288 271 1002 359">The duplex mode (data transfer mode) has changed. The cause for the status [Half] can be a defective plug, a defective cable or the pulling or plugging of the network connector.</p> <p data-bbox="288 363 716 391">Corrective measures if the status is [Half]:</p> <ul data-bbox="311 399 1008 550" style="list-style-type: none"> <li data-bbox="311 399 1008 486">• Ensure that with an Ethernet connection, the network cable and the network connector are not damaged and that the network connectors are correctly plugged. <li data-bbox="311 494 1008 550">• Ensure that the DHCP server (router) and any network switches are signaling correct operation.
10255	<p data-bbox="311 566 599 598">⚠ QUALIFIED PERSON</p> <p data-bbox="288 614 599 646">[Interface]: Network load OK</p> <p data-bbox="288 654 901 678">The network load has returned to a normal range after being busy.</p>
10282	<p data-bbox="288 694 711 726">[User group]-Login via [protocol] locked</p> <p data-bbox="288 726 968 813">After several incorrect login attempts, login has been blocked for a limited time. In this case, the User login will be blocked for 15 minutes, the Grid Guard login for 12 hours.</p> <p data-bbox="288 821 509 845">Corrective measures:</p> <ul data-bbox="311 853 862 885" style="list-style-type: none"> <li data-bbox="311 853 862 885">• Wait until the given time has expired and then retry login.
10283	<p data-bbox="311 901 599 933">⚠ QUALIFIED PERSON</p> <p data-bbox="288 949 509 981">WLAN module faulty</p> <p data-bbox="288 981 812 1013">The WLAN module integrated in the inverter is defective.</p> <p data-bbox="288 1021 509 1045">Corrective measures:</p> <ul data-bbox="311 1053 879 1080" style="list-style-type: none"> <li data-bbox="311 1053 879 1080">• Contact the Service (see Section 16 "Contact", page 101).

Event number	Message, cause and corrective measures
10284	<p>⚠ QUALIFIED PERSON</p> <p>No WLAN connection possible</p> <p>The inverter does not currently have a WLAN connection to the selected network.</p> <p>Corrective measures:</p> <ul style="list-style-type: none"> • Ensure that the SSID, the WLAN password and the encryption method have been entered correctly. The encryption method is specified by your WLAN router or WLAN Access Point and can be changed there. • Ensure that the WLAN router or WLAN Access Point is in range and is signaling correct operation. • If this message is displayed often, improve the WLAN connection by using a WLAN repeater.
10285	<p>WLAN connection established</p> <p>Connection to the selected WLAN network has been established.</p>
10286	<p>⚠ QUALIFIED PERSON</p> <p>WLAN connection lost</p> <p>The inverter has lost WLAN connection to the selected network.</p> <p>Corrective measures:</p> <ul style="list-style-type: none"> • Ensure that the WLAN router or WLAN Access Point is still active. • Ensure that the WLAN router or WLAN Access Point is in range and is signaling correct operation. • If this message is displayed often, improve the WLAN connection by using a WLAN repeater.
10339	Webconnect enabled
10340	Webconnect disabled
10341	Webconnect error: no connection
10343	Webconnect error: Default gateway not configured
10344	Webconnect error: DNS server not configured
10345	Webconnect error: No reply to DNS request [xx]
10346	Webconnect error: Unknown SIP proxy [xx]
10347	Webconnect error: Unknown STUN server [xx]
10348	Webconnect error: No reply to request to STUN server
10349	Webconnect error: No reply to SIP option packs
10350	Webconnect error: Registration rejected by SIP registrar

Event number	Message, cause and corrective measures
10351	Webconnect error: Unknown SIP registrar [xx]
10352	Webconnect error: Faulty communication
10353	Webconnect error: registration of the SIP registry has not responded
10502	Active power limited AC frequency
10901	Start self-test [xx]
10902	Uac RPro [xxx] V
10903	Uac Max [xxx] V
10904	Uac Min [xxx] V
10905	Uac Min Fast [xxx] V
10906	Fac SwMax [xxx] Hz
10907	Fac SwMin [xxx] Hz
10908	Fac Max [xxx] Hz
10909	Fac Min [xxx] Hz
10910	Disconn. threshold [xxx] [xx]
10911	Stand. Val. [xxx] [xx]
10912	Disconn. time [xx] s
27103	Set parameter The parameter changes are being adopted.
27104	Parameters set successfully The parameter changes were successfully adopted.
27107	Update file OK The update file found is valid.
27301	Update communication The inverter is updating the communication component.
27302	Update main CPU The inverter is updating the inverter component.
27312	Update completed The inverter has successfully completed the update.

Event number	Message, cause and corrective measures
29001	<p>Inst. code valid</p> <p>The entered Grid Guard code is valid. Protected parameters have now been unlocked and you can adjust the parameters. The parameters will be automatically locked again after ten feed-in hours.</p>
29004	<p>Grid parameters unchanged</p> <p>Changing the grid parameters is not possible.</p>

12.2 LED Signals

The LEDs indicate the operating state of the inverter.

LED	Status	Explanation
Green LED	flashing: 2 s on 2 s off	<p>Waiting for feed-in conditions</p> <p>The conditions for feed-in operation are not yet met. As soon as the conditions are met, the inverter will start feed-in operation.</p>
	flashing quickly	<p>Update of central processing unit</p> <p>The central processing unit of the inverter is being updated.</p>
	glowing	<p>Feed-in operation</p> <p>The inverter feeds in with a power of at least 90%.</p>
	pulsing	<p>Feed-in operation</p> <p>The inverter is equipped with a dynamic power display via the green LED. Depending on the power, the green LED pulses fast or slow. If necessary, you can switch off the dynamic power display via the green LED.</p>
	Off	The inverter is not feeding into the utility grid.
Red LED	glowing	<p>Event occurred</p> <p>If an event occurs, a distinct event message and the corresponding event number will be displayed in addition on the inverter user interface or in the communication product.</p>

LED	Status	Explanation
Blue LED	flashes slowly for approx. one minute	Communication connection is being established The inverter is establishing a connection to a local network or is establishing a direct connection to an end device via Ethernet (e.g. computer, tablet PC or smartphone).
	flashes quickly for approx. two minutes	WPS active The WPS function is active.
	glowing	Communication active There is an active connection with a local network or there is a direct connection with an end device via Ethernet (e.g. computer, tablet PC or smartphone).

12.3 Forgotten Password

If you have forgotten the password for the inverter, you can unlock the inverter with a Personal Unlocking Key (PUK). For each inverter, there is one PUK for each user group (**User** and **Installer**). Useful hint: With PV systems in Sunny Portal, you can also assign a new password via Sunny Portal for the user group **Installer**. The password for the user group **Installer** is the same as the system password in Sunny Portal.

Procedure:

1. Request PUK (application form available at www.SMA-Solar.com).
2. Activate the user interface (see Section 8.1, page 49).
3. Enter the PUK instead of the password into the field **Password**.
4. Select **Login**.
5. Call up the menu **Device Parameters**.
6. Select [**Edit parameters**].
7. In the parameter group **User Rights > Access Control** change the password of the desired user group.
8. Select [**Save all**] to save the changes.

PV Systems in Sunny Portal

The password for the user group **Installer** is also the system password for the PV system in Sunny Portal. Changing the password of the user group **Installer** can lead to the inverter no longer being able to be reached by Sunny Portal.

- Assign the changed password of the user group **Installer** as the new system password in Sunny Portal (see the Sunny Portal user manual at www.SMA-Solar.com).

12.4 Checking the PV System for Ground Faults

⚠ QUALIFIED PERSON

If the red LED is glowing and the event number 3501, 3601 or 3701 is being displayed in the **Results** menu on the inverter user interface, there may be a ground fault present. The electrical insulation from the PV system to ground is defective or insufficient.

⚠ WARNING

Danger to life due to electric shock

In the event of a ground fault, high voltages can be present.

- Touch the cables of the PV array on the insulation only.
- Do not touch any parts of the substructure or frame of the PV array.
- Do not connect PV strings with ground faults to the inverter.

NOTICE

Destruction of the measuring device due to overvoltage

- Only use measuring devices with a DC input voltage range of 1000 V or higher.

Procedure:

In order to check the PV system for ground faults, perform the following actions in the prescribed order. The exact procedure is described in the following sections.

- Check the PV system for ground faults by measuring the voltage.
- If the voltage measurement was not successful, check the PV system via insulation resistance measurement for ground faults.

Test by Measuring the Voltage

Proceed as follows to check each string in the PV system for ground faults.

Procedure:

1. **⚠ DANGER**

Danger to life due to high voltages

- Disconnect the inverter from all voltage sources (see Section 10, page 67).
2. Measure the voltages:
 - Measure the voltage between the positive terminal and the ground potential (PE).
 - Measure the voltage between the negative terminal and the ground potential (PE).

- Measure the voltage between the positive and negative terminals.
If the following results are present at the same time, there is a ground fault in the PV system:
 - ☑ All measured voltages are stable.
 - ☑ The sum of the two voltages to ground potential is approximately equal to the voltage between the positive and negative terminals.
- If a ground fault is present, determine the location of the ground fault via the ratio of the two measured voltages and eliminate the ground fault.

Example: Location of the ground fault

The example shows a ground fault between the second and third PV module.

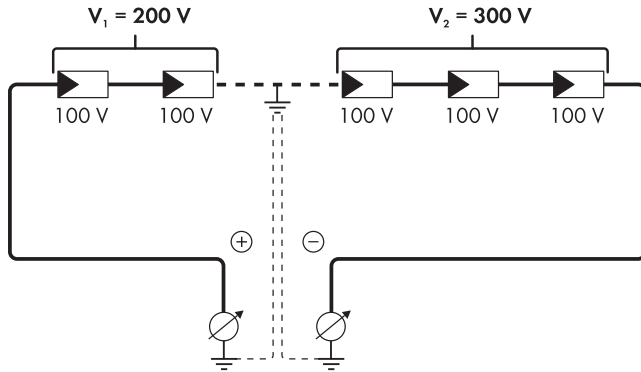

3. If a definite ground fault cannot be measured and the message is still displayed, measure the insulation resistance.
4. Reconnect the strings without ground faults to the inverter and recommission the inverter.

Test by Measuring the Insulation Resistance

If the voltage measurement does not provide sufficient evidence of a ground fault, the insulation resistance measurement can provide more exact results.

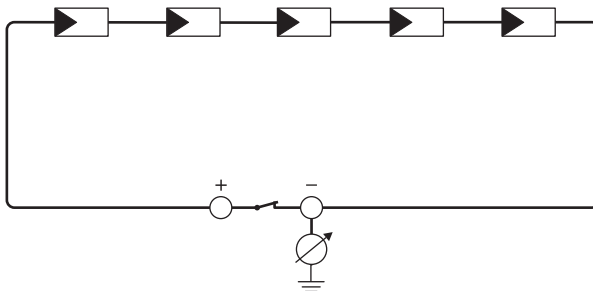

Figure 16: Schematic diagram of the measurement

Calculating the insulation resistance

The expected total resistance of the PV system or of an individual string can be calculated using the following formula:

$$\frac{1}{R_{\text{total}}} = \frac{1}{R_1} + \frac{1}{R_2} + \frac{1}{R_3} + \dots$$

The exact insulation resistance of a PV module can be obtained from the module manufacturer or the datasheet.

For the resistance of a PV module an average value can be assumed: for thin-film PV modules approximately 40 MOhm and for polycrystalline and monocrystalline PV modules approximately 50 MOhm per PV module (for further information on calculating the insulation resistance see the Technical Information "Insulation Resistance (Riso) of Non-Galvanically Isolated PV Systems" at www.SMA-Solar.com).

Required devices:

- Suitable device for safe disconnection and short-circuiting
- Measuring device for insulation resistance

Device required for safe disconnection and short-circuiting of the PV array

The insulation resistance can only be measured with a suitable device for safe disconnection and short-circuiting of the PV array. If no suitable device is available, the insulation measurement must not be carried out.

Procedure:

1. Calculate the expected insulation resistance per string.

2.  **DANGER**

Danger to life due to high voltages

- Disconnect the inverter from all voltage sources (see Section 10, page 67).

3. Install the short circuit device.

4. Connect the measuring device for insulation resistance.

5. Short-circuit the first string.

6. Set the test voltage. The test voltage should be as close as possible to the maximum system voltage of the PV modules but must not exceed it (see datasheet of the PV modules).

7. Measure the insulation resistance.

8. Eliminate the short circuit.

9. Measure the remaining strings in the same manner.

- If the insulation resistance of a string deviates considerably from the theoretically calculated value, there is a ground fault present in that string.

10. Reconnect to the inverter only those strings from which the ground fault has been eliminated.

11. Reconnect all other strings to the inverter.

12. Recommission the inverter.
13. If the inverter still displays an insulation error, contact the Service (see Section 16 "Contact", page 101). The PV modules might not be suitable for the inverter in the present quantity.

12.5 Updating the Firmware

QUALIFIED PERSON

If no automatic update is set in the communication product (e.g. Cluster Controller) or via the user interface of the inverter, you have two possibilities to update the inverter firmware:

- Update the firmware via the user interface of the inverter.
- Update the firmware via USB flash drive.

Updating Firmware via the User Interface

Requirement:

- An update file with the desired inverter firmware must be available. The update file is, for example, available for download on the product page of the inverter at www.SMA-Solar.com.

Procedure:

1. Activate the user interface (see Section 8.1, page 49).
2. Log into the user interface (see Section 8.2, page 52).
3. Select the menu **System Configuration**.
4. Select [**Settings**].
5. In the context menu, select [**Updating the firmware**].
6. Follow the instructions in the dialog.

Updating the Firmware via USB Flash Drive

Requirement:

- A USB flash drive with maximum 32 GB and file system FAT32 must be available.

Procedure:

1. Create an "UPDATE" folder on the USB stick.
2. Save the update file with the desired firmware in the "UPDATE" folder on the USB flash drive. The update file is, for example, available for download on the product page of the inverter at www.SMA-Solar.com.

3. DANGER

Danger to life due to high voltages

- Disconnect the inverter from all voltage sources and open the enclosure lid of the DC connection unit (see Section 10, page 67).
4. Insert the USB flash drive in the USB port on the communication assembly.

5. Commission the inverter (see Section 7.2, page 43).

- During start-up phase of the inverter, the desired firmware is being installed.

6. ** DANGER**

Danger to life due to high voltages

- Disconnect the inverter from all voltage sources and open the enclosure lid of the DC connection unit (see Section 10, page 67).

7. Pull the USB flash drive out of the USB port.

8. Commission the inverter (see Section 7.2, page 43).

9. Call up the user interface of the inverter and check the events to see whether a firmware update has been successfully completed.

10. If the firmware update has not been successfully completed, perform the firmware update again.

13 Decommissioning the Inverter

⚠ QUALIFIED PERSON

To decommission the inverter completely upon completion of its service life, proceed as described in this Section.

⚠ CAUTION

Risk of injury when lifting the inverter, or if it is dropped

The inverter weighs 84 kg. You risk injury if you lift the inverter incorrectly or if it is dropped while being transported or mounted.

- Carry and lift the inverter in an upright position with several people without tilting it.

Requirements:

- A pallet must be available.
- Original packaging with paddings must be available.
- All transport handles must be in place.

Procedure:

1. ⚠ DANGER

Danger to life due to high voltages

- Disconnect the inverter from all voltage sources (see Section 10, page 67).

2. ⚠ CAUTION

Risk of burns due to hot enclosure parts

- Wait 30 minutes for the enclosure to cool down.

3. Remove the AC cable from the inverter. Loosen the screws with an Allen key (AF 8) and pull the cables out of the terminal.

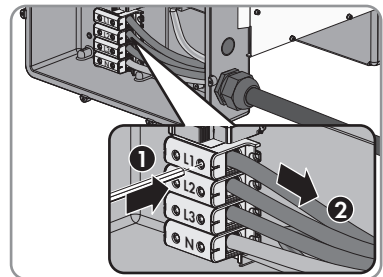

4. Disconnect the grounding conductor from the grounding terminal. To do so, loosen the screws with a Torx screwdriver (TX 25) and pull the grounding conductor out under the clip.

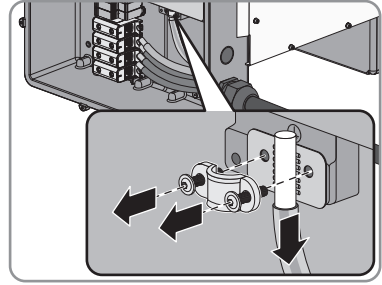

5. Remove the AC cable from the inverter.
6. Remove the M63 cable gland from the enclosure opening in the AC connection unit. To do so, remove the inside counter nut and remove the cable gland from the enclosure opening.
7. When the AC surge arresters are inserted, pull the surge arresters out of the slots. To do so, squeeze the grooved areas on the left and right sides of the surge arrester.

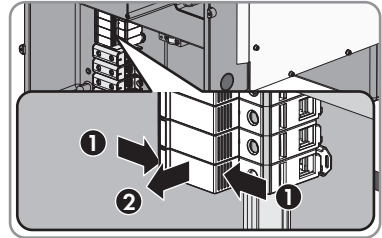

8. Position the enclosure lid of the AC connection unit on the AC connection unit and first tighten the upper-left and lower-right screws, and then the remaining screws crosswise using a Torx screwdriver (TX 25) (torque: 6 Nm).

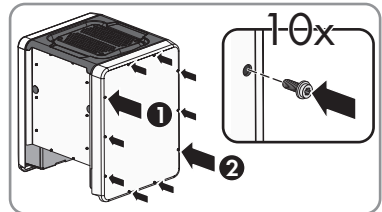

9. Unscrew all ten screws of the enclosure lid of the DC connection unit with a Torx screwdriver (TX 25) and remove the enclosure lid towards the front.

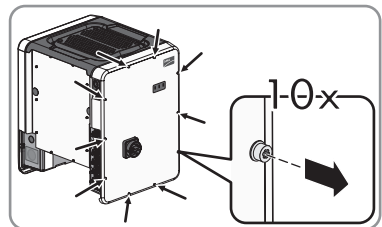

10. Set the screws and the enclosure lid aside and store safely.

11. Remove all connection cables from the communication assembly and pull out the connection cables out of the DC connection unit.

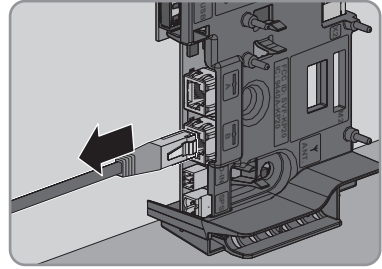

12. Remove all cable glands from the inverter. To do so, unscrew the counter nut from inside and remove the cable gland from the enclosure opening.
13. When the DC arresters are inserted, pull the surge arresters out of the slots. To do so, squeeze the grooved areas on the left and right sides of the surge arrester.

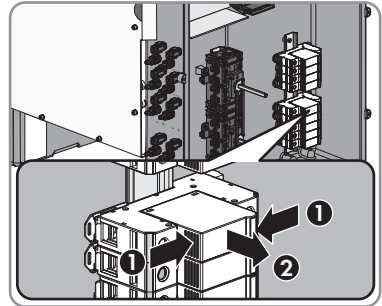

14. Position the enclosure lid of the DC connection unit on the DC connection unit and first tighten the upper-left and lower-right screws, and then the remaining screws crosswise using a Torx screwdriver (TX 25) (torque: 6 Nm).

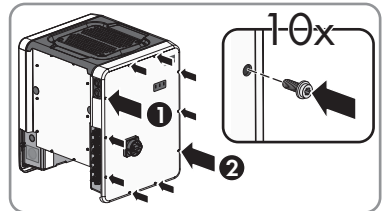

15. Screw all four transport handles as far as they will go into the taps on the right- and left-hand side until they lie flush with the enclosure. When doing so, ensure that the transport handles are screwed into the taps so that they are perfectly straight. If the transport handles are not screwed in straight, this can make it more difficult or even impossible to unscrew them later on and can damage the taps to the extent that transport handles can no longer be screwed into them.

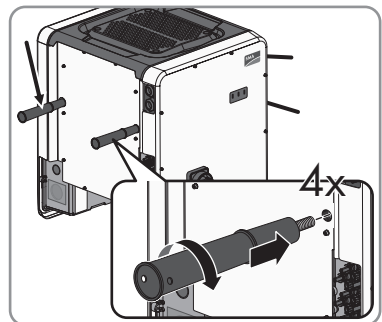

16. Insert a screwdriver into the holes in the transport handle and turn the screwdriver through 90° . This ensures that the transport handles are securely tightened.

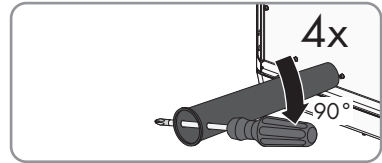

17. To remove the feet or profile rails, lay the inverter carefully on the AC connection unit side.
18. If the inverter is to be stored or shipped, pack the inverter in its original packaging.
- Place the lower part of the original packaging with padding on the pallet
 - Place the inverter with padding on the pallet. For this purpose, put the AC connection unit side of the inverter on top of the padding.
 - Remove all four transport handles from the taps. If necessary, insert a screwdriver into the holes on the transport handle and use the screwdriver to remove the transport handle.
 - Pull the upper part of the original packaging over the inverter.
 - Insert the upper padding.
 - Close the packaging.
 - Secure the packaging and pallet with strapping or with fastening belts.
19. Dispose of the inverter in accordance with the locally applicable disposal regulations for electronic waste.

14 Technical Data

DC Input

Maximum DC power at $\cos \varphi = 1$	51000 W
Maximum input voltage	1000 V
MPP voltage range	150 V to 1000 V
Rated input voltage	500 V to 800 V
Minimum usable input voltage	150 V
Initial input voltage	188 V
Maximum input current per DC connector	20 A
Maximum input current per input	20 A
Maximum short-circuit current per input*	30 A
Number of independent MPP inputs	6
Strings per MPP input	2
Overvoltage category in accordance with IEC 62109-1	II

* In accordance with IEC 62109-2: $I_{SC PV}$

AC Output

Rated power at 230 V, 50 Hz	50000 W
Maximum apparent AC power	50000 VA
Rated grid voltage	230 V
Nominal AC voltage	400 V / 230 V
AC voltage range*	202 V to 264 V
Nominal AC current at 230 V	72.5 A
Maximum output current	72.5 A
Maximum output current under fault conditions	440 A _{peak}
Duration of the maximum output current in the event of a fault	26 ms
Total harmonic distortion of the output current with total harmonic distortion of the AC voltage < 2%, and AC power > 50% of the rated power	< 2 %
Rated power frequency	50 Hz
AC power frequency*	50 Hz / 60 Hz
Operating range at AC power frequency 50 Hz	44 Hz to 55 Hz

Operating range at AC power frequency 60 Hz	54 Hz to 65 Hz
Power factor at rated power	1
Displacement power factor, adjustable	0.0 overexcited to 0.0 underexcited
Feed-in phases	3
Phase connection	3 (+1)
Overvoltage category in accordance with IEC 62109-1	III
* Depending on the configured country data set	

Multifunction Relay

Maximum DC switching voltage	30 V
Maximum AC switching current	1.0 A
Maximum DC switching current	1.0 A
Minimum load	0.1 W
Minimum electrical endurance when the maximum switching voltage and maximum switching current are complied with*	100000 switching cycles
* Corresponds to 20 years at 12 switching operations per day	

Efficiency

Maximum efficiency, η_{\max}	> 98.1 %
European weighted efficiency, η_{EU}	> 97.8 %

Protective Devices

DC reverse polarity protection	Short-circuit diode
Input-side disconnection point	DC load-break switch
DC overvoltage protection	Surge arrester type II (optional)
AC short-circuit current capability	Current control
Grid monitoring	SMA Grid Guard 3
Maximum permissible fuse protection	100 A
Ground fault monitoring	Insulation monitoring: $R_{\text{iso}} > 34 \text{ k}\Omega$
All-pole sensitive residual-current monitoring unit	Available

General Data

Width x height x depth, without feet or DC load-break switch	592 mm x 733 mm x 679 mm
--	--------------------------

Weight	84 kg
Length x width x height of the packaging	800 mm x 600 mm x 886 mm
Transport weight	100 kg
Climatic category in accordance with IEC 60721-3-4	4K4H
Environmental category	Outdoors
Pollution degree of all enclosure parts	2
Operating temperature range	-25 °C to +60 °C
Maximum permissible value for relative humidity, non-condensing	100 %
Maximum operating altitude above mean sea level (MSL)	3000 m
Typical noise emission	< 60 dB(A)
Power loss in night mode	5 W
Topology	Transformerless
Cooling method	SMA OptiCool
Number of fans	3
Degree of protection for electronics in accordance with IEC 60529	IP65
Protection class in accordance with IEC 62109-1	I
Grid configurations	TN-C, TN-S, TN-C-S, TT (when $V_{N,PE} < 20$ V)
National standards and approvals, as per 05/2017*	ANRE 30, AS 4777, BDEW 2008, C10/11:2012, CE, CEI 0-16, CEI 0-21, EN 50438:2013, G59/3, IEC 60068-2-x, IEC 61727, IEC 62109-1/2, IEC 62116, MEA 2013, NBR 16149, NEN EN 50438, NRS 091-2-1, PEA 2013, PPC, RD 1699/413, RD 661/2007, Res. n°7:2013, SI4777, TOR D4, TR 3.2.2, UTE C15-712-1, VDE 0126-1-1, VDE-ARN 4105, VFR 2014, P.O.12.3, NTCO-NTCyS, GC 8.9H, PR20, DEWA

* **EN 50438:2013** Does not apply to all country standard deviations of EN 50438

IEC 62109-2: In order to meet the requirements of this standard, the inverter must either be equipped with a multifunction relay used as a fault indicator contact or there must be a connection to Sunny Portal with the fault alarm in Sunny Portal activated.

Climatic Conditions

Installation in accordance with IEC 60721-3-4, Class 4K4H

Extended temperature range	-25 °C to +60 °C
Extended humidity range	0% to 100%
Threshold for relative humidity, non-condensing	100 %
Extended air pressure range	79.5 kPa to 106 kPa

Transport in accordance with IEC 60721-3-4, Class 2K3

Temperature range	-40 °C to +70 °C
-------------------	------------------

Equipment

DC connection	SUNCLIX DC connector
AC connection	Screw terminals
Multifunction relay	As standard
Surge protection devices Type II for AC and/or DC	Optional

Torques

Screws for the DC Connection Unit and AC Connection Unit enclosure lids.	6 Nm
Screws for AC terminals with conductor cross-section of 35 mm ² to 95 mm ²	20 Nm
Screws for AC terminals with conductor cross-section of 120 mm ²	30 Nm
Screws for attaching the feet or profile rails	16 Nm
Screws of the cover on the top of the inverter.	10 Nm
Counter nut of M63 cable gland	14 Nm
Swivel nut for M63 cable gland	33 Nm
Swivel nut for M32 cable gland	5 Nm
SUNCLIX swivel nut	2 Nm

Data Storage Capacity

Daily energy yields	63 days
Daily yields	30 years
Event messages for users	1024 events
Event messages for installers	1024 events

15 Accessories

You will find the accessories for your product in the following overview. If required, these can be ordered from SMA Solar Technology AG or your distributor.

Designation	Short designation	SMA order number
SMA Sensor Module	Interface for one SMA inverter as retrofit kit for capturing environmental data (e.g. solar irradiation, ambient temperature, cell temperature, wind speed or SO meters).	MD.SEN-40
SMA Antenna Extension Kit	Accessory set for one SMA inverter for the optimization of the SMA inverter's WLAN radio range.	EXTANT-40
SMA 485 Module	Interface for establishing cable-bound communication via RS485	MD.485-40
SMA I/O modules	Interface to implement of grid management services	MD.IO-40

16 Contact

If you have technical problems with our products, please contact the SMA Service Line. We require the following information in order to provide you with the necessary assistance:

- Inverter device type
- Inverter serial number
- Inverter firmware version
- Special country-specific settings of the inverter (if applicable)
- Type and number of PV modules connected
- Mounting location and altitude of the inverter
- Inverter message
- Optional equipment, e.g. communication products
- If necessary, system name in the Sunny Portal
- If necessary, access data in the Sunny Portal
- Operating mode of the multifunction relay

Danmark	SMA Solar Technology AG	Belgien	SMA Benelux BVBA/SPRL
Deutschland	Niestetal	Belgique	Mechelen
Österreich	Sunny Boy, Sunny Mini Central,	België	+32 15 286 730
Schweiz	Sunny Tripower: +49 561 9522-1499	Luxemburg	SMA Online Service Center: www.SMA-Service.com
	Monitoring Systems (Kommunikationsprodukte): +49 561 9522-2499	Luxembourg	
	Fuel Save Controller (PV-Diesel-Hybridsysteme): +49 561 9522-3199	Nederland	
	Sunny Island, Sunny Boy Storage, Sunny Backup, Hydro Boy: +49 561 9522-399	Česko	SMA Service Partner
	Sunny Central, Sunny Central Storage: +49 561 9522-299	Magyarország	TERMS a.s. +420 387 6 85 111
	SMA Online Service Center: www.SMA-Service.com	Slovensko	SMA Online Service Center: www.SMA-Service.com
		Türkiye	SMA Service Partner DEKOM Ltd. Şti. +90 24 22430605 SMA Online Service Center: www.SMA-Service.com

France	SMA France S.A.S. Lyon +33 472 22 97 00 SMA Online Service Center : www.SMA-Service.com	Ελλάδα Κύπρος	SMA Service Partner AKTOR FM. Αθήνα +30 210 8184550 SMA Online Service Center: www.SMA-Service.com
España Portugal	SMA Ibérica Tecnología Solar, S.L.U. Barcelona +34 935 63 50 99 SMA Online Service Center: www.SMA-Service.com	United Kingdom	SMA Solar UK Ltd. Milton Keynes +44 1908 304899 SMA Online Service Center: www.SMA-Service.com
Italia	SMA Italia S.r.l. Milano +39 02 8934-7299 SMA Online Service Center: www.SMA-Service.com	Bulgaria România Slovenija Hrvatska	SMA Service Partner Renovatio Solar +40 372 756 599 SMA Online Service Center: www.SMA-Service.com
United Arab Emirates	SMA Middle East LLC Abu Dhabi +971 2234 6177 SMA Online Service Center: www.SMA-Service.com	India	SMA Solar India Pvt. Ltd. Mumbai +91 22 61713888
ไทย	SMA Solar (Thailand) Co., Ltd. ประเทศไทย +66 2 670 6999	대한민국	SMA Technology Korea Co., Ltd. 서울 +82-2-520-2666

South Africa	SMA Solar Technology South Africa Pty Ltd. Cape Town 08600SUNNY (08600 78669) International: +27 (0)21 826 0600 SMA Online Service Center: www.SMA-Service.com	Argentina Brasil Chile Perú	SMA South America SPA Santiago de Chile +562 2820 2101
--------------	--	--------------------------------------	--

Australia	SMA Australia Pty Ltd. Sydney Toll free for Australia: 1800 SMA AUS (1800 762 287) International: +61 2 9491 4200	Other countries	International SMA Service Line Niestetal 00800 SMA SERVICE (+800 762 7378423)
-----------	--	-----------------	--

17 EU Declaration of Conformity

within the meaning of the EU directives

- Electromagnetic compatibility 2014/30/EU (29.3.2014 L 96/79-106) (EMC)
- Low Voltage Directive 2014/35/EU (29.3.2014 L 96/357-374) (LVD)
- Radio Equipment Directive 2014/53/EU (22.5.2014 L 153/62) (RED)



SMA Solar Technology AG confirms herewith that the inverters described in this document are in compliance with the fundamental requirements and other relevant provisions of the above-mentioned directives. The entire EU Declaration of Conformity can be found at www.SMA-Solar.com.

