

Service Manual for Installers

**SUNNY TRIPOWER 15000TL / 17000TL /
20000TL / 25000TL**

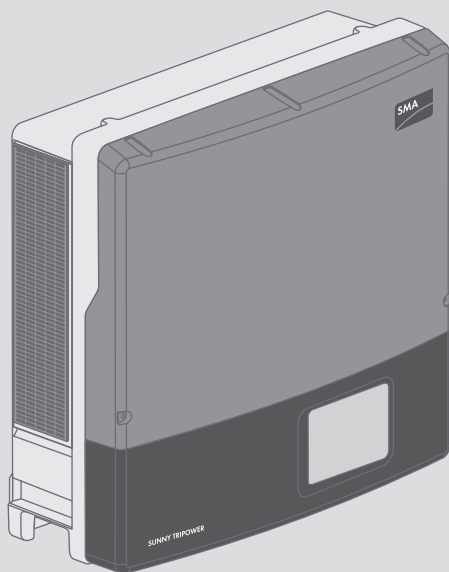

Legal Provisions

The information contained in these documents is property of SMA Solar Technology AG. Any publication, whether in whole or in part, requires prior written approval by SMA Solar Technology AG. Internal reproduction used solely for the purpose of product evaluation or other proper use is allowed and does not require prior approval.

SMA Warranty

You can download the current warranty conditions from the Internet at www.SMA-Solar.com.

Trademarks

All trademarks are recognized, even if not explicitly identified as such. Missing designations do not mean that a product or brand is not a registered trademark.

Modbus[®] is a registered trademark of Schneider Electric and is licensed by the Modbus Organization, Inc.

QR Code is a registered trademark of DENSO WAVE INCORPORATED.

Phillips[®] and Pozidriv[®] are registered trademarks of Phillips Screw Company.

Torx[®] is a registered trademark of Acument Global Technologies, Inc.

SMA Solar Technology AG

Sonnenallee 1

34266 Niestetal

Germany

Tel. +49 561 9522-0

Fax +49 561 9522-100

www.SMA.de

Email: info@SMA.de

Copyright © 2016 SMA Solar Technology AG. All rights reserved.

Table of Contents

1	Information on this Document	4
1.1	Validity	4
1.2	Target group	4
1.3	Symbols.....	4
1.4	Nomenclature	5
2	Safety	6
2.1	Safety Information	6
2.2	Disconnecting the Inverter from Voltage Sources.....	7
3	Cleaning the Inverter	11
4	Retrofitting the Surge Arrester Type II.....	12
5	Troubleshooting.....	13
5.1	Event Messages.....	13
5.2	Error Messages.....	14
6	Cleaning the Fans.....	23
6.1	Cleaning the Fan at the Bottom	23
6.2	Cleaning the Fan on the Left-Hand Side of the Enclosure.....	24
7	Checking the Function of the Fans	27
8	Checking the PV System for Ground Faults	28
9	Checking the Function of the Surge Arresters.....	32
10	Replacing the Surge Arrester	34
11	Recommissioning the Inverter	36
12	Procedure for Receiving a Replacement Device.....	39
13	Decommissioning the Inverter.....	43
14	Spare Parts	45
15	Contact	46

1 Information on this Document

1.1 Validity

This document describes how to rectify certain errors and how to replace defective components. This document supplements the documents that are enclosed with each product and does not replace any locally applicable standards or directives. Read and observe all documents supplied with the product.

This document is valid for the following device types:





- STP 15000TL-30 (Sunny Tripower 15000TL)
- STP 17000TL-30 (Sunny Tripower 17000TL) (This device is only available as a service product)
- STP 20000TL-30 (Sunny Tripower 20000TL)
- STP 25000TL-30 (Sunny Tripower 25000TL)

1.2 Target group

The tasks described in this document must only be performed by qualified persons. Qualified persons must have the following skills:

- Knowledge of how an inverter works and is operated
- Training in how to deal with the dangers and risks associated with installing and using electrical devices and installations
- Training in the installation and commissioning of electrical devices and installations
- Knowledge of the applicable standards and directives
- Knowledge of and compliance with this document and all safety information

1.3 Symbols

Symbol	Explanation
 DANGER	Indicates a hazardous situation which, if not avoided, will result in death or serious injury
 WARNING	Indicates a hazardous situation which, if not avoided, can result in death or serious injury
 CAUTION	Indicates a hazardous situation which, if not avoided, can result in minor or moderate injury
NOTICE	Indicates a situation which, if not avoided, can result in property damage
	Information that is important for a specific topic or goal, but is not safety-relevant
<input type="checkbox"/>	Indicates a requirement for meeting a specific goal

Symbol	Explanation
☑	Desired result
✘	A problem that might occur

1.4 Nomenclature

Complete designation	Designation in this document
Sunny Tripower	Inverter, product

2 Safety

2.1 Safety Information

This section contains safety information that must be observed at all times when working on or with the product.

To prevent personal injury and property damage and to ensure long-term operation of the product, read this section carefully and observe all safety information at all times.

DANGER

Danger to life due to high voltages of the PV array

When exposed to sunlight, the PV array generates dangerous DC voltage, which is present in the DC conductors and the live components of the inverter. Touching the DC conductors or the live components can lead to lethal electric shocks. If you disconnect the DC connectors from the inverter under load, an electric arc may occur leading to electric shock and burns.

- Do not touch non-insulated cable ends.
- Do not touch the DC conductors.
- Do not touch any live components of the inverter.
- Have the inverter mounted, installed and commissioned only by qualified persons with the appropriate skills.
- If an error occurs, have it rectified by qualified persons only.
- Prior to performing any work on the inverter, disconnect it from all voltage sources as described in this document.

DANGER

Danger to life due to electric shock

Touching an ungrounded PV module or array frame can cause a lethal electric shock.

- Connect and ground the PV modules, array frame and electrically conductive surfaces so that there is continuous conduction. Observe the applicable local regulations.

CAUTION

Risk of burns due to hot enclosure parts

Some parts of the enclosure can get hot during operation.

- Do not touch any parts other than the lower enclosure lid of the inverter during operation.

NOTICE**Damage to seals on the enclosure lids in subfreezing conditions**

If you open the upper and lower enclosure lids when temperatures are below freezing, the enclosure seals can be damaged. This can lead to moisture entering the inverter.

- Do not open the inverter at ambient temperatures lower than -5°C .
- If a layer of ice has formed on the seal of the lid when temperatures are below freezing, remove it prior to opening the enclosure lids of the inverter (e.g. by melting the ice with warm air). Observe the applicable safety regulations.

2.2 Disconnecting the Inverter from Voltage Sources

Prior to performing any work on the inverter, always disconnect it from all voltage sources as described in this section. Always adhere to the prescribed sequence.

NOTICE**Damage to seals on the enclosure lids in subfreezing conditions**

If you open the upper and lower enclosure lids when temperatures are below freezing, the enclosure seals can be damaged. This can lead to moisture entering the inverter.

- Do not open the inverter at ambient temperatures lower than -5°C .
- If a layer of ice has formed on the seal of the lid when temperatures are below freezing, remove it prior to opening the enclosure lids of the inverter (e.g. by melting the ice with warm air). Observe the applicable safety regulations.

NOTICE**Destruction of the measuring device due to overvoltage**

- Only use measuring devices with a DC input voltage range of 1000 V or higher.

Procedure:

1. Disconnect the circuit breaker from all three line conductors and secure it against reconnection.
2. Turn the DC load-break switch to the position **O**.

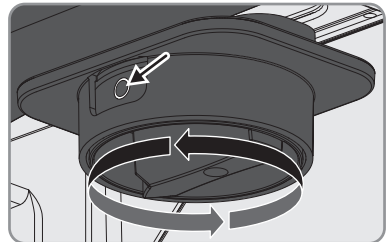

3. If the multifunction relay is used, switch off any supply voltage to the load.

- 4. Wait until the LEDs have gone out and, if necessary, the load connected to the multifunction relay has been switched off.
- 5. Use a current clamp to ensure that no current is present in the DC cables.
- 6. Unscrew the two screws on the DC load-break switch using an Allen key (AF 3).

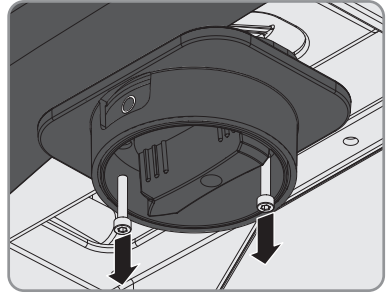

- 7. Pull the DC load-break switch down and out of the recess.

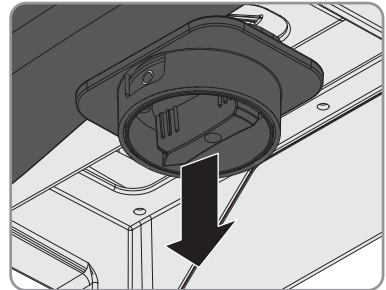

- 8. Remove all six screws from the lower enclosure lid using an Allen key (AF 3).

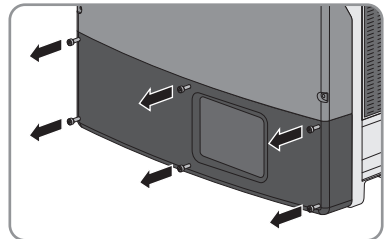

- 9. Lift and remove the lower enclosure lid from below.

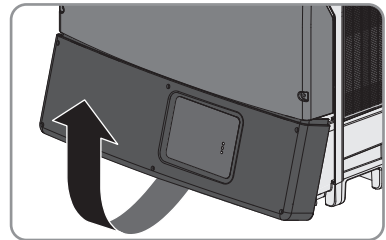

10. **CAUTION**

Risk of burns when touching the DC protective cover

The DC protective cover can get hot during operation.

- Do not touch the DC protective cover.

11. Release and remove all DC connectors. Insert a slotted screwdriver or an angled screwdriver (blade width 3.5 mm) into one of the slide slots and pull the DC connectors out downwards. Do not pull on the cable.

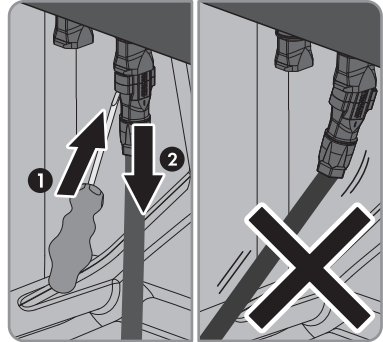

12. Ensure that no voltage is present at the DC inputs of the inverter.

13. Use an appropriate measuring device to ensure that no voltage is present at the AC connecting terminal plate between **L1** and **N**, **L2** and **N**, and **L3** and **N**. Insert the test probe of the multimeter into the round opening of the terminal.

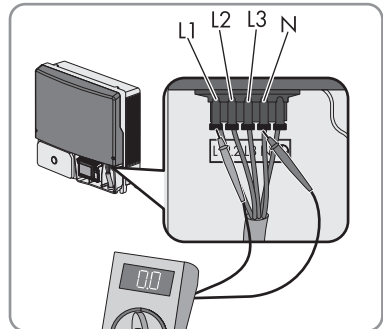

14. Use an appropriate measuring device to ensure that no voltage is present at the AC connecting terminal plate between **L1** and **PE**, **L2** and **PE**, and **L3** and **PE**. Insert the test probe into the round opening of each terminal.

15. Ensure that no voltage is present between any terminal of the multifunction relay and **PE** of the AC connecting terminal plate.

16. **DANGER**

Danger to life due to high voltages in the inverter

The capacitors in the inverter take 20 minutes to discharge.

- Wait 20 minutes before opening the upper enclosure lid.
- Do not open the DC protective cover.

17.

NOTICE**Damage to the inverter due to electrostatic discharge**

Touching electronic components can cause damage to or destroy the inverter through electrostatic discharge.

- Ground yourself before touching any component.

3 Cleaning the Inverter

NOTICE**Damage to the inverter due to the use of cleaning agents**

- If the inverter is dirty, clean the enclosure, the enclosure lid, the type label and the LEDs using only clean water and a cloth.
- Ensure that the inverter is free of dust, foliage and other dirt.

4 Retrofitting the Surge Arrester Type II

The inverter is equipped ex works with surge arresters or it can be retrofitted (see Section 14 "Spare Parts", page 45).

1. **⚠ DANGER**

Danger to life due to high voltages

- Disconnect the inverter from all voltage sources (see Section 2.2, page 7).
 - Wait 20 minutes before you remove the DC protective cover to allow residual voltages to discharge.
2. Release the screws on the DC protective cover using an Allen key (AF 3), lift the DC protective cover upwards from below and remove it.

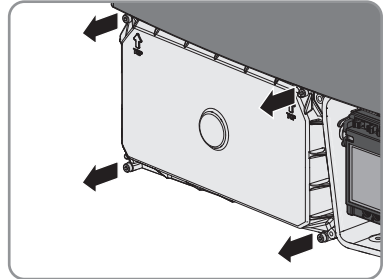

3. Plug the new surge arresters into the designated slots until they lock into place with the locking tabs. The inspection window must be located on the right-hand side.

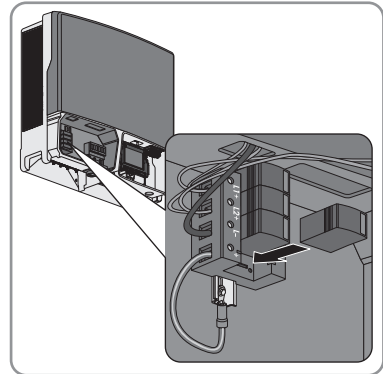

4. Position the DC protective cover at the upper edge, flip down and tighten it (torque: 3.5 Nm).

5 Troubleshooting

5.1 Event Messages

Message	Cause
Inst. code valid	The entered Grid Guard code is valid. Protected parameters have now been unlocked and you can adjust the parameters. The parameters will be automatically locked again after ten feed-in hours.
Self-test	The self-test is in progress.
Set parameter	The parameter change has been adopted.
Parameters set successfully	The parameter changes were successfully adopted.
Update file OK	The update file found is valid.
SD card is read	Memory card is being searched for update file and the update file is being checked.
No new update SDcard	An update file that has already been used is on the memory card.
Update communication	The inverter is updating the communication component.
Update main CPU	The inverter is updating the inverter component.
Update RS485i module	The inverter is updating the corresponding component.
Update Speedwire	The inverter is updating the corresponding component.
Webconnect update	The inverter is updating the corresponding component.
Upd. language table	The inverter is updating the corresponding component.
Update completed	The inverter has successfully completed the update.
Grid param. unchanged	The selected rotary switch position is not assigned or the grid parameters cannot be changed.
Grid param. locked	The parameters are locked and you cannot change them.

5.2 Error Messages

The communication product (e.g. Sunny Explorer) displays the warnings and errors that apply to the inverter, the utility grid or the PV array. The warning or error is identified by an event number and the corresponding message.

Event number	Message, cause and corrective measures
101 ... 103	<p>Grid fault</p> <p>The grid voltage or grid impedance at the connection point of the inverter is too high. The inverter has disconnected from the utility grid.</p> <p>Corrective measures:</p> <ul style="list-style-type: none"> • Check whether the grid voltage at the connection point of the inverter is permanently in the permissible range. <p>If the grid voltage is outside the permissible range due to local grid conditions, contact the grid operator. The grid operator must agree with an adjustment of the voltage at the feed-in point or with a change of the monitored operating limits.</p> <p>If the grid voltage is permanently within the permissible range and this message is still displayed, contact the SMA Service Line.</p>
202 ... 203	<p>Grid fault</p> <p>The utility grid has been disconnected, the AC cable is damaged or the grid voltage at the connection point of the inverter is too low. The inverter has disconnected from the utility grid.</p> <p>Corrective measures:</p> <ol style="list-style-type: none"> 1. Make sure that the circuit breaker is switched on. 2. Make sure that the AC cable is not damaged. 3. Make sure that the AC cable is correctly connected. 4. Check whether the grid voltage at the connection point of the inverter is permanently in the permissible range. <p>If the grid voltage is outside the permissible range due to local grid conditions, contact the grid operator. The grid operator must agree with an adjustment of the voltage at the feed-in point or with a change of the monitored operating limits.</p> <p>If the grid voltage is permanently within the permissible range and this message is still displayed, contact the SMA Service Line.</p>

Event number	Message, cause and corrective measures
301	<p>Grid fault</p> <p>The ten-minute average value of the grid voltage is no longer within the permissible range. The grid voltage or grid impedance at the connection point is too high. The inverter disconnects from the utility grid to maintain power quality.</p> <p>Corrective measures:</p> <ul style="list-style-type: none"> • Check whether the grid voltage at the connection point of the inverter is permanently in the permissible range. <p>If the grid voltage is outside the permissible range due to local grid conditions, contact the grid operator. The grid operator must agree with an adjustment of the voltage at the feed-in point or with a change of the monitored operating limits.</p> <p>If the grid voltage is permanently within the permissible range and this message is still displayed, contact the SMA Service Line.</p>
401 ... 404	<p>Grid fault</p> <p>The inverter is no longer in grid-parallel operation and has stopped feeding into the utility grid.</p> <p>Corrective measures:</p> <ul style="list-style-type: none"> • Check the grid connection for significant short-term frequency fluctuations.
501	<p>Grid fault</p> <p>The power frequency is not within the permissible range. The inverter has disconnected from the utility grid.</p> <p>Corrective measures:</p> <ul style="list-style-type: none"> • If possible, check the power frequency and observe how often fluctuations occur. <p>If fluctuations occur frequently and this message is displayed often, contact the grid operator. The grid operator must approve changes to the operating parameters of the inverter.</p> <p>If the grid operator gives its approval, discuss any changes to the operating parameters with the SMA Service Line.</p>
601	<p>Grid fault</p> <p>The inverter has detected an excessively high proportion of direct current in the grid current.</p> <p>Corrective measures:</p> <ol style="list-style-type: none"> 1. Check the grid connection for direct current. 2. If this message is displayed frequently, contact the grid operator and check whether the monitoring threshold on the inverter can be raised.

Event number	Message, cause and corrective measures
701	<p>Frq. not permitted > Check parameter</p> <p>The power frequency is not within the permissible range. The inverter has disconnected from the utility grid.</p> <p>Corrective measures:</p> <ul style="list-style-type: none"> • If possible, check the power frequency and observe how often fluctuations occur. <p>If fluctuations occur frequently and this message is displayed often, contact the grid operator. The grid operator must approve changes to the operating parameters of the inverter.</p> <p>If the grid operator gives its approval, discuss any changes to the operating parameters with the SMA Service Line.</p>
1302	<p>Waiting for grid voltage > Installation failure grid connection > Check grid and fuses</p> <p>The inverter has detected an error in the AC cabling. The inverter cannot connect to the utility grid.</p> <p>Corrective measures:</p> <ol style="list-style-type: none"> 1. Ensure that the AC connection is correct (see the operating manual for inverter at www.SMA-Solar.com). 2. Ensure that the country data set has been configured correctly. Select the parameter Set country standard or CntrySet and check its value.
1501	<p>Reconnection fault grid</p> <p>The changed country data set or the value of a parameter you have set does not correspond to the local requirements. The inverter cannot connect to the utility grid.</p> <p>Corrective measures:</p> <ul style="list-style-type: none"> • Ensure that the country data set has been configured correctly. Select the parameter Set country standard or CntrySet and check its value.
3301	<p>Unstable operation > Generator output too low</p> <p>There is not enough power at the DC input of the inverter for stable operation. This may be caused by snow on the PV modules or insufficient irradiation. The inverter interrupts feed-in operation and can no longer connect to the utility grid.</p> <p>Corrective measures:</p> <ol style="list-style-type: none"> 1. If irradiation is too low, wait for it to increase. 2. If this message is displayed frequently, ensure that the PV array has been correctly rated and wired.

Event number	Message, cause and corrective measures
3302	<p>Unstable operation > Abort self-test</p> <p>There is not enough power at the DC input of the inverter for stable operation. This may be caused by snow on the PV modules or insufficient irradiation. The inverter interrupts feed-in operation and can no longer connect to the utility grid.</p> <p>Corrective measures:</p> <ol style="list-style-type: none"> 1. If irradiation is too low, wait for it to increase. 2. If this message is displayed frequently, ensure that the PV array has been correctly rated and wired.
3303	<p>Unstable operation > Data storage blocked</p> <p>There is not enough power at the DC input of the inverter for stable operation. This may be caused by snow on the PV modules or insufficient irradiation. The inverter interrupts feed-in operation and can no longer connect to the utility grid.</p> <p>Corrective measures:</p> <ol style="list-style-type: none"> 1. If irradiation is too low, wait for it to increase. 2. If this message is displayed frequently, ensure that the PV array has been correctly rated and wired.
3401 ... 3402	<p>DC overvoltage > Disconnect generator</p> <p>Overvoltage at the DC input. This can destroy the inverter.</p> <p>Corrective measures:</p> <ol style="list-style-type: none"> 1. Immediately disconnect the inverter from all voltage sources (see Section 2.2, page 7). 2. Check whether the DC voltage is below the maximum input voltage of the inverter. <p>If the DC voltage is below the maximum input voltage of the inverter, reconnect the DC connectors to the inverter.</p> <p>If the DC voltage is above the maximum input voltage of the inverter, ensure that the PV array has been correctly rated or contact the installer of the PV array.</p> <ol style="list-style-type: none"> 3. If this message is repeated frequently, contact the SMA Service Line.
3501	<p>Insulation resistance > Check generator</p> <p>The inverter has detected a ground fault in the PV array.</p> <p>Corrective measures:</p> <ul style="list-style-type: none"> • Check the PV system for ground faults (see Section 8, page 28).

Event number	Message, cause and corrective measures
3601	<p>High discharge curr. > Check generator</p> <p>The leakage currents of the inverter and the PV array are too high. There is a ground fault, a residual current or a malfunction.</p> <p>The inverter interrupts feed-in operation immediately after exceeding a threshold and then automatically reconnects to the utility grid. If this process happens five times a day, the inverter disconnects from the utility grid and terminates feed-in.</p> <p>Corrective measures:</p> <ul style="list-style-type: none"> • Check the PV system for ground faults (see Section 8, page 28).
3701	<p>Resid.curr.too.high > Check generator</p> <p>The inverter has detected a residual current due to temporary grounding of the PV array.</p> <p>Corrective measures:</p> <ul style="list-style-type: none"> • Check the PV system for ground faults (see Section 8, page 28).
3801 ... 3802	<p>DC overcurrent > Check generator</p> <p>Overcurrent at the DC input. The inverter briefly interrupts feed-in operation.</p> <p>Corrective measures:</p> <ul style="list-style-type: none"> • If this message is displayed frequently, ensure that the PV array has been correctly rated and wired.
3901 ... 3902	<p>Waiting for DC start conditions > Start cond. not met</p> <p>The feed-in conditions for the utility grid are not yet fulfilled.</p> <p>Corrective measures:</p> <ol style="list-style-type: none"> 1. If irradiation is too low, wait for it to increase. 2. If this message is displayed frequently in the morning, increase the voltage limit for starting grid feed-in. Change the parameter Minimum voltage input or A.VStr, B.VStr. 3. If this message is displayed frequently with medium irradiation, ensure that the PV array is correctly rated.
6001 ... 6438	<p>Self diagnosis > Interference device</p> <p>The cause must be determined by the SMA Service Line.</p> <p>Corrective measures:</p> <ul style="list-style-type: none"> • Contact the SMA Service Line.
6501 ... 6511	<p>Self diagnosis > Interference device</p> <p>The inverter has switched off due to excessive temperature.</p> <p>Corrective measures:</p> <ol style="list-style-type: none"> 1. Clean the fans (see Section 6, page 23). 2. Ensure that the inverter has sufficient ventilation.

Event number	Message, cause and corrective measures
6512	<p>Minimum operating temperature not reached</p> <p>The inverter will only recommence grid feed-in once the temperature has reached at least -25°C.</p>
6603 ... 6604	<p>Self-diagnosis > Overload</p> <p>The cause must be determined by the SMA Service Line.</p> <p>Corrective measures:</p> <ul style="list-style-type: none"> • Contact the SMA Service Line.
6606	<p>Interference device</p> <p>The cause must be determined by the SMA Service Line.</p> <p>Corrective measures:</p> <ul style="list-style-type: none"> • Contact the SMA Service Line.
6701 ... 6702	<p>Communication disturbed</p> <p>The cause must be determined by the SMA Service Line.</p> <p>Corrective measures:</p> <ul style="list-style-type: none"> • Contact the SMA Service Line.
6801 ... 6802	<p>Self-diagnosis > Input A defective</p> <p>The cause must be determined by the SMA Service Line.</p> <p>Corrective measures:</p> <ul style="list-style-type: none"> • Contact the SMA Service Line.
6901 ... 6902	<p>Self-diagnosis > Input B defective</p> <p>The cause must be determined by the SMA Service Line.</p> <p>Corrective measures:</p> <ul style="list-style-type: none"> • Contact the SMA Service Line.
7001 ... 7002	<p>Sensor fault fan permanently on</p> <p>The cause must be determined by the SMA Service Line.</p> <p>Corrective measures:</p> <ul style="list-style-type: none"> • Contact the SMA Service Line.
7101	<p>SD card defective</p> <p>The SD memory card is not formatted.</p> <p>Corrective measures:</p> <ul style="list-style-type: none"> • Re-format the SD memory card. • Re-save the files to the SD memory card.

Event number	Message, cause and corrective measures
7102	<p>Parameter file not found or defective</p> <p>The parameter file was not found or is defective. The update failed. The inverter continues feeding power into the grid.</p> <p>Corrective measures:</p> <ul style="list-style-type: none"> • Copy the parameter file to the correct folder again.
7105	<p>Param. setting failed</p> <p>Parameters could not be set using the memory card. The inverter continues feeding power into the grid.</p> <p>Corrective measures:</p> <ul style="list-style-type: none"> • Ensure that the parameters are set correctly. • Ensure that the SMA Grid Guard code is available.
7106	<p>Update file defect.</p> <p>Update file on the memory card is defective.</p> <p>Corrective measures:</p> <ul style="list-style-type: none"> • Reformat the memory card. • Re-save the files to the memory card.
7110	<p>No update file found</p> <p>No update file has been found.</p> <p>Corrective measures:</p> <ul style="list-style-type: none"> • Copy the update file to the memory card folder. Select the folder \UPDATE.
7201 ... 7202	<p>Data stor. not poss.</p> <p>Internal error. The inverter continues to feed into the utility grid.</p> <p>Corrective measures:</p> <ul style="list-style-type: none"> • Contact the SMA Service Line.
7303	<p>Update main CPU failed</p> <p>The cause must be determined by the SMA Service Line.</p> <p>Corrective measures:</p> <ul style="list-style-type: none"> • Contact the SMA Service Line.
7305	<p>Update RS485I module failed</p> <p>Update of RS485i module failed.</p> <p>Corrective measures:</p> <ul style="list-style-type: none"> • Retry update. • If the error recurs, contact the SMA Service Line.

Event number	Message, cause and corrective measures
7311	<p>Update language table failed Updating the language table failed.</p> <p>Corrective measures:</p> <ul style="list-style-type: none"> • Retry update. • If the error recurs, contact the SMA Service Line.
7316	<p>Update Speedwire module failed Updating the Speedwire module failed.</p> <p>Corrective measures:</p> <ul style="list-style-type: none"> • Retry update. • If the error recurs, contact the SMA Service Line.
7326	<p>Webconnect update failed Update of Webconnect module failed.</p> <p>Corrective measures:</p> <ul style="list-style-type: none"> • Retry update. • If the error recurs, contact the SMA Service Line.
7701 ... 7703	<p>Self diagnosis > Interference device The cause must be determined by the SMA Service Line.</p> <p>Corrective measures:</p> <ul style="list-style-type: none"> • Contact the SMA Service Line.
8001	<p>Derating occurred The inverter has reduced its power output for more than ten minutes due to excessive temperature.</p> <p>Corrective measures:</p> <ul style="list-style-type: none"> • Clean the cooling fins on the rear of the enclosure and the air ducts on the top using a soft brush. • Ensure that the inverter has sufficient ventilation.
8101 ... 8104	<p>Communication disturbed The cause must be determined by the SMA Service Line.</p> <p>Corrective measures:</p> <ul style="list-style-type: none"> • Contact the SMA Service Line.
9002	<p>Installer code invalid The SMA Grid Guard code entered is incorrect. The operating parameters are still protected and cannot be changed.</p> <p>Corrective measures:</p> <ul style="list-style-type: none"> • Enter the correct SMA Grid Guard code.

Event number	Message, cause and corrective measures
9003	<p data-bbox="288 177 527 209">Grid parameter locked</p> <p data-bbox="288 209 919 240">The parameters are now locked. You cannot change the parameters.</p> <p data-bbox="288 240 508 272">Corrective measures:</p> <ul data-bbox="311 272 852 304" style="list-style-type: none"><li data-bbox="311 272 852 304">• Unlock the parameters with the SMA Grid Guard code.
9005	<p data-bbox="288 320 930 352">Changing of grid parameters not possible > Ensure DC supply.</p> <p data-bbox="288 352 994 424">PV power is too low for setting the country data set. As soon as sufficient irradiation is available, the inverter assumes the setting automatically.</p>

6 Cleaning the Fans

6.1 Cleaning the Fan at the Bottom

First clean the fan at the bottom of the inverter and then clean the fan on the left-hand side of the enclosure.

Procedure:

1. **⚠ DANGER**

Danger to life due to electric shock

- Disconnect the inverter from all voltage sources (see Section 2.2 "Disconnecting the Inverter from Voltage Sources", page 7).

2. Wait for the fan to stop rotating.

3. Remove the fan guard and clean it:

- Use a screwdriver to push the two locking tabs at the right-hand edge of the fan guard to the right-hand side and remove them from the retainer.

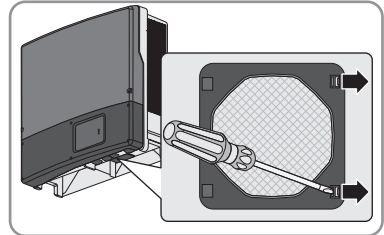

- Carefully remove the fan guard.
- Clean the fan guard with a soft brush, a paint brush, a cloth or compressed air.

4. Press the locking tabs on the fan toward the center of the fan.

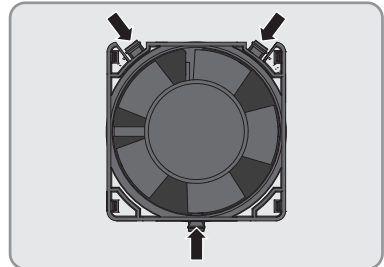

5. Carefully remove the fan from the inverter.

6. Release and remove the fan plug.

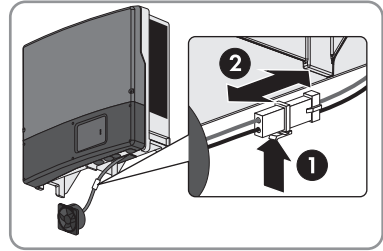

7. **NOTICE**

Damage to the fan due to compressed air

- Clean the fan only with a soft brush, a paint brush, or a damp cloth.

8. After cleaning, insert the fan plug back into the pin connector until it snaps into place.

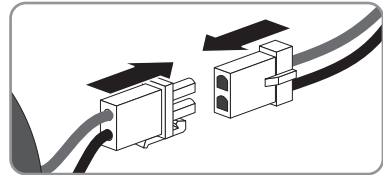

9. Insert the fan into the inverter until it snaps into place.

10. Push the fan guard into the retainer until it snaps into place.

11. Clean the fan on the left-hand side of the enclosure (see Section 6.2 "Cleaning the Fan on the Left-Hand Side of the Enclosure", page 24).

6.2 Cleaning the Fan on the Left-Hand Side of the Enclosure

1. **DANGER**

Danger to life due to electric shock

- Ensure that the inverter is disconnected from all voltage sources (see Section 2.2 "Disconnecting the Inverter from Voltage Sources", page 7).
2. Remove the ventilation grids on the left-hand and right-hand sides and clean them:
- Turn the rotary fastener of the ventilation grid with a flat-blade screwdriver until the notch is in a vertical position.

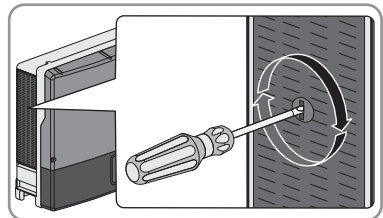

- Remove the ventilation grid. Use a screwdriver to gently lever open the ventilation grid.

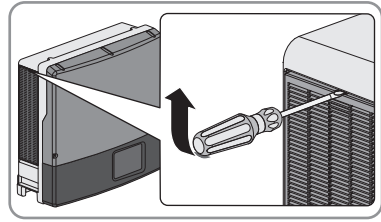

- Clean the ventilation grid with a soft brush, a paint brush, or compressed air.

3. **NOTICE**

Damage to the inverter due to foreign bodies

- Do not remove the ventilation grids permanently, otherwise foreign bodies could penetrate the enclosure.

4. Wait for the fan to stop rotating.
5. Press the locking tabs on the fan toward the center of the fan.

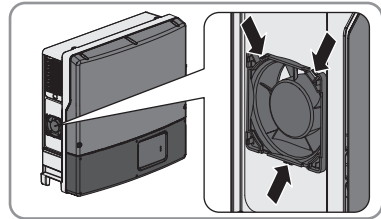

6. Carefully remove the fan from the inverter.
7. Release and remove the fan plug.

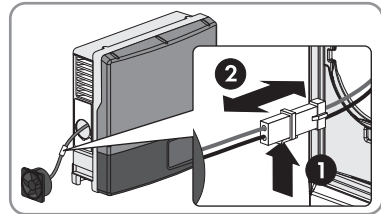

8. **NOTICE**

Damage to the fan due to compressed air

- Clean the fan only with a soft brush, a paint brush, or a damp cloth.

9. After cleaning, insert the fan plug into the pin connector until it snaps into place.

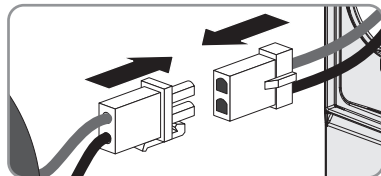

10. Insert the fan into the inverter until it snaps into place.

11. Attach the ventilation grids on the right-hand and left-hand side of the inverter:

- Reinsert the ventilation grid until it snaps into place.

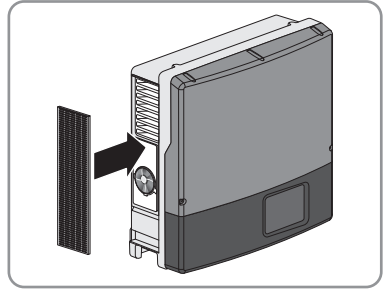

- Turn the rotary lock of the ventilation grid with a flat-blade screwdriver until the slot is in a horizontal position and the arrows point to the right.

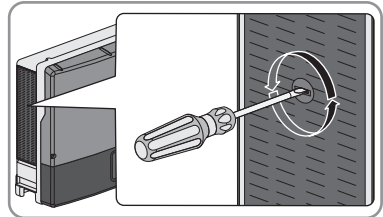

- Ensure that the ventilation grid is securely in place.

12. Recommission the inverter (see Section 11, page 36).

13. Check the fans to ensure that they are working properly (see Section 7, page 27).

7 Checking the Function of the Fans

You can check the function of the fans by setting a parameter.

The basic procedure for changing operating parameters is described in the manual of the inverter or the communication product (see the operating manual of the inverter or communication product).

Procedure:

1. Select the parameter **Fan test** or **FanTst** and set to **On**.
2. Save settings.
3. Check whether air is being drawn in through the bottom and is coming out of the upper ventilation grids and whether the fans are making any unusual noises.

If no air is being drawn in through the bottom, no air is coming out of the ventilation grids, or the fans are making unusual noises, then the fans were presumably installed improperly.

Check whether the fans have been installed correctly.

If the fans were installed correctly, contact Service (see Section 15, page 46).

4. Select the parameter **Fan test** or **FanTst** and set to **Off**.
5. Save settings.

8 Checking the PV System for Ground Faults

If the inverter displays the event numbers **3501**, **3601** or **3701**, there could be a ground fault. The electrical insulation from the PV system to ground is defective or insufficient.

WARNING

Danger to life due to electric shock

In the event of a ground fault, high voltages can be present.

- Touch the cables of the PV array on the insulation only.
- Do not touch any parts of the substructure or frame of the PV array.
- Do not connect PV strings with ground faults to the inverter.

NOTICE

Destruction of the measuring device due to overvoltage

- Only use measuring devices with a DC input voltage range of 1000 V or higher.

Procedure:

In order to check the PV system for ground faults, perform the following actions in the prescribed order. The exact procedure is described in the following sections.

- Check the PV system for ground faults by measuring the voltage.
- If the voltage measurement was not successful, check the PV system via insulation resistance measurement for ground faults.

Test by Measuring the Voltage

Proceed as follows to check each string in the PV system for ground faults.

Procedure:

1. **DANGER**

Danger to life due to high voltages

- Disconnect the inverter from all voltage sources (see Section 2.2, page 7).

2. Measure the voltages:

- Measure the voltage between the positive terminal and the ground potential (PE).
- Measure the voltage between the negative terminal and the ground potential (PE).
- Measure the voltage between the positive and negative terminals.

If the following results are present at the same time, there is a ground fault in the PV system:

- All measured voltages are stable.
- The sum of the two voltages to ground potential is approximately equal to the voltage between the positive and negative terminals.

- If a ground fault is present, determine the location of the ground fault via the ratio of the two measured voltages and eliminate the ground fault.

Example: Location of the ground fault

The example shows a ground fault between the second and third PV module.

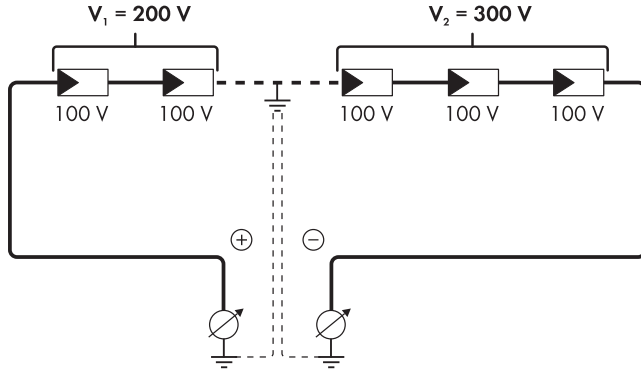

3. If a definite ground fault cannot be measured and the message is still displayed, measure the insulation resistance.
4. Reconnect the strings without ground faults to the inverter and recommission the inverter.

Test by Measuring the Insulation Resistance

If the voltage measurement does not provide sufficient evidence of a ground fault, the insulation resistance measurement can provide more exact results.

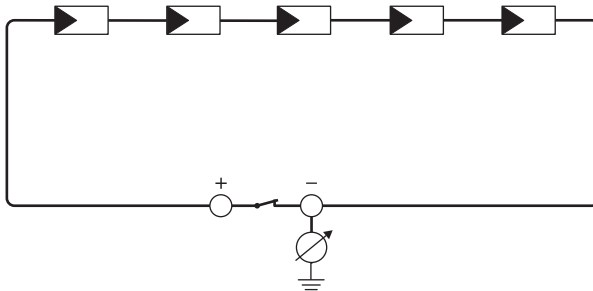

Figure 1: Schematic diagram of the measurement

Calculating the insulation resistance

The expected total resistance of the PV system or of an individual string can be calculated using the following formula:

$$\frac{1}{R_{\text{total}}} = \frac{1}{R_1} + \frac{1}{R_2} + \frac{1}{R_3} + \dots$$

The exact insulation resistance of a PV module can be obtained from the module manufacturer or the datasheet.

For the resistance of a PV module an average value can be assumed: for thin-film PV modules approximately 40 MOhm and for polycrystalline and monocrystalline PV modules approximately 50 MOhm per PV module (for further information on calculating the insulation resistance see the Technical Information "Insulation Resistance (Riso) of Non-Galvanically Isolated PV Systems" at www.SMA-Solar.com).

Required devices:

- Suitable device for safe disconnection and short-circuiting
- Measuring device for insulation resistance

Device required for safe disconnection and short-circuiting of the PV array

The insulation resistance can only be measured with a suitable device for safe disconnection and short-circuiting of the PV array. If no suitable device is available, the insulation measurement must not be carried out.

Procedure:

1. Calculate the expected insulation resistance per string.

2.  **DANGER**

Danger to life due to high voltages

- Disconnect the inverter from all voltage sources (see Section 2.2, page 7).

3. Install the short circuit device.

4. Connect the measuring device for insulation resistance.

5. Short-circuit the first string.

6. Set the test voltage. The test voltage should be as close as possible to the maximum system voltage of the PV modules but must not exceed it (see datasheet of the PV modules).

7. Measure the insulation resistance.

8. Eliminate the short circuit.

9. Measure the remaining strings in the same manner.

- If the insulation resistance of a string deviates considerably from the theoretically calculated value, there is a ground fault present in that string.

10. Reconnect to the inverter only those strings from which the ground fault has been eliminated.

11. Reconnect all other strings to the inverter.

12. Recommission the inverter.
13. If the inverter still displays an insulation error, contact the Service (see Section 15 "Contact", page 46). The PV modules might not be suitable for the inverter in the present quantity.

9 Checking the Function of the Surge Arresters

Surge arresters are wearing parts. Their functionality diminishes with age or following repeated exposure to overvoltage. It is therefore possible for the surge arresters to lose their protective function over time.

Check the function of the surge arresters as described in the following.

Procedure:

1. **⚠ DANGER**

Danger to life due to electric shock

- Disconnect the inverter from all voltage sources (see Section 2.2, page 7).
- Wait 20 minutes before removing the DC protective cover.

2. Release the screws on the DC protective cover using an Allen key (AF 3), lift the DC protective cover upwards from below and remove it.

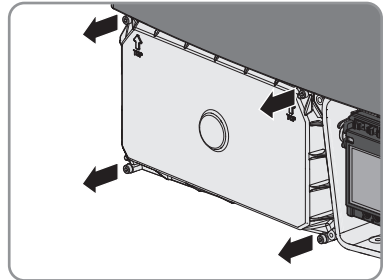

3. Check whether one of the surge arresters is defective.

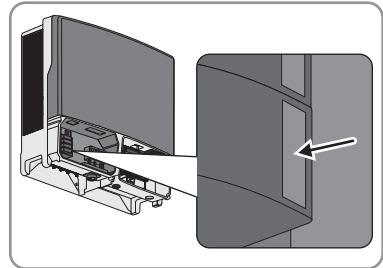

If no stripe is visible next to the type designation in the inspection window of the surge arrester, the surge arrester is in good condition.

If a red stripe is visible next to the type designation in the inspection window of the surge arrester, the surge arrester is defective.

- Order new surge arresters.
- If new surge arresters are available, replace all surge arresters (see Section 10, page 34).

4. Tighten all four screws on the DC protective cover with an Allen key (AF 3) in the sequence 1 to 4 (torque: $3 \text{ Nm} \pm 0.3 \text{ Nm}$).

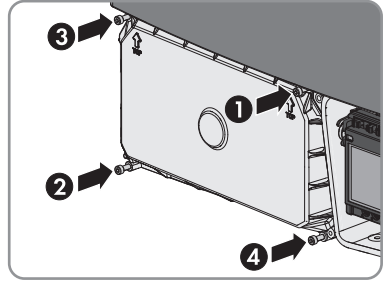

5. Recommission the inverter (see Section 1.1 "Recommissioning the Inverter", page 36).

10 Replacing the Surge Arrester

If at least one surge arrester is defective, SMA Solar Technology AG recommends replacing all surge arresters.

Procedure:

1. **⚠ DANGER**

Danger to life due to electric shock

- Disconnect the inverter from all voltage sources and open the lower enclosure lid (see Section 2.2, page 7).
- Wait 20 minutes before removing the DC protective cover.

2. Release the screws on the DC protective cover using an Allen key (AF 3), lift the DC protective cover upwards from below and remove it.

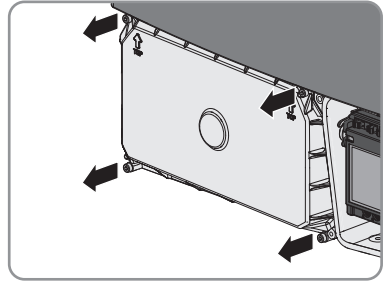

3. Pull all surge arresters out of the slots. To do so, squeeze the grooved areas on the left and right sides of the surge arrester.

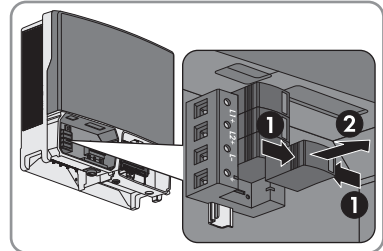

4. Remove the red protective ring from the middle contact on the bottom of each surge arrester.

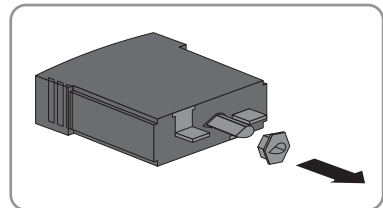

5. Plug the new surge arresters into the designated slots until they lock into place with the locking tabs. The inspection window on each surge arrester must face to the right.

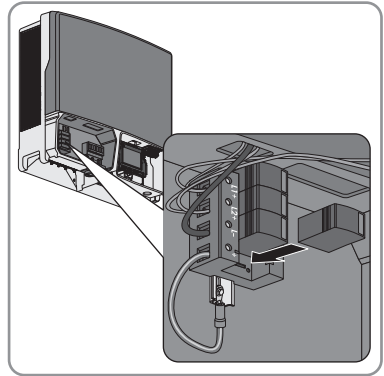

6. Ensure that each surge arrester is securely inserted into its slot.
7. Tighten all four screws on the DC protective cover with an Allen key (AF 3) in the sequence 1 to 4 (torque: $3 \text{ Nm} \pm 0.3 \text{ Nm}$).

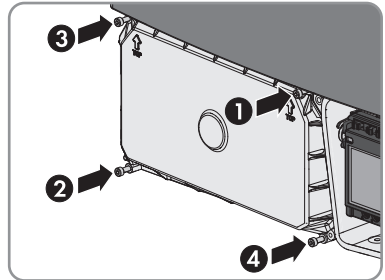

11 Recommissioning the Inverter

If you have disconnected the inverter from all voltage sources (e.g. for configuration purposes) and want to recommission it, proceed as follows.

Requirements:

- The inverter must be correctly mounted.
- The DC connectors must be correctly assembled.
- The AC cable must be connected correctly.

Procedure:

1. Make sure that the AC cable is routed so that it cannot be damaged by the partition in the lower enclosure lid.
2. Connect the assembled DC connectors to the inverter.
 - The DC connectors snap into place.
3. Seal all unused DC inputs using the DC connectors with sealing plugs.
4. Insert the lower enclosure lid from above and fold it down. The screws must protrude from the lower enclosure lid.

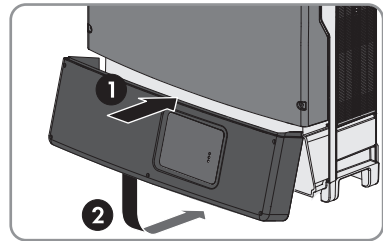

5. Tighten all six screws with an Allen key (AF 3) in the order 1 to 6 (torque: $2.0 \text{ Nm} \pm 0.3 \text{ Nm}$). By tightening the screws in the prescribed order, you avoid warping the enclosure lid, which would keep it from sealing correctly. Useful hint: If the screws fall out of the lower enclosure lid, insert the long screw into the lower middle hole and the five short screws into the other holes.

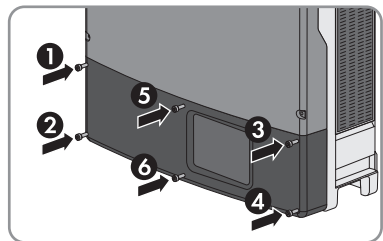

6. Set the DC load-break switch to position **O** so that both mounting screws are visible.

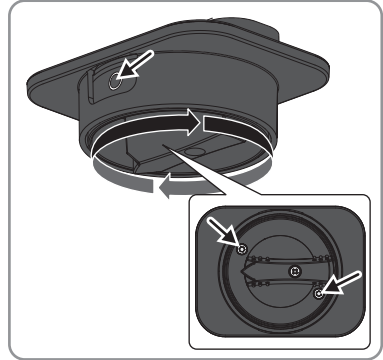

7. Insert the DC load-break switch firmly into the recess on the inverter. During this process, the DC load-break switch must still be in position **O** and aligned so that the screws are positioned over the threads.
8. Fasten the two screws using an Allen key (AF 3) (torque: $2 \text{ Nm} \pm 0.2 \text{ Nm}$).

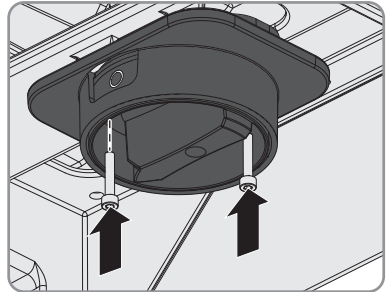

9. Turn the DC load-break switch of the inverter to position I.

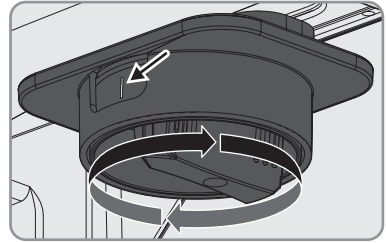

10. Switch on the circuit breaker of all three line conductors.

- All three LEDs start to glow and the start-up phase begins. The start-up phase may take several minutes.
- The green LED is glowing. Feed-in operation begins.
- The green LED is flashing?

Possible cause of error: the DC input voltage is still too low or the inverter is monitoring the utility grid.

- Once the DC input voltage is sufficiently high and the grid connection conditions are met, the inverter will start operation.
- The red LED is glowing and an error message and event number appear in the display?
 - Eliminate the error (see Section 5 "Troubleshooting", page 13).

1.2 Procedure for Receiving a Replacement Device

Under fault conditions, the inverter may need to be replaced. If this is the case, you will receive a replacement device from SMA Solar Technology AG. If you received a replacement device, replace the defective inverter with the replacement device as described in this section.

Procedure:

- Decommission the defective inverter.
- Commission the replacement device.
- Ship the defective inverter.

Decommissioning the Defective Inverter

⚠ CAUTION

Risk of injury when lifting the inverter, or if it is dropped

The inverter weighs 61 kg. There is risk of injury if the inverter is lifted incorrectly or dropped while being transported or when attaching it to or removing it from the wall mounting bracket.

- Carry and lift the inverter in an upright position with several people without tilting it. With one hand grasp the recessed grip, and with the other hand support the top part of the enclosure. This will prevent the inverter tipping forward.
- If the inverter is to be transported and lifted with a crane, remove the filler plugs on the top of the inverter and screw the eye bolts into the threads.

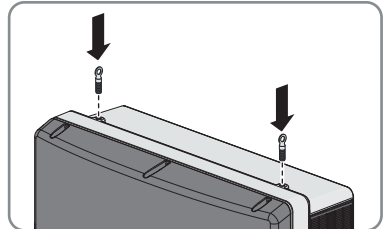
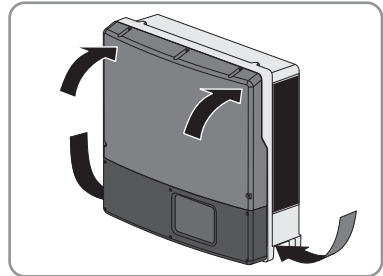

1. **⚠ DANGER**

Danger to life due to electric shock

- Disconnect the inverter from all voltage sources (see Section 2.2, page 7).
2. Remove the AC cable from the inverter. Press the locking levers all the way upward and pull the conductors out of the connecting terminal plate for the AC cable.
3. Press down the locking levers of the connecting terminal plate for the AC cable.
4. Remove the cable for the additional grounding from the grounding terminal, if necessary.

5. If the multi-function relay or the SMA Power Control Module are used, remove the connection cable from the inverter.
6. If other cables (e.g. data cables or network cables) are connected, remove them from the inverter.
7. Remove any installed interfaces from the inverter (see the manual for the communication interface).
8. If surge arresters are present, remove the surge arresters from the defective inverter (see Section 10, page 34).
9. Close all enclosure openings.
10. Keep the DC load-break switch in a safe place as the replacement device will be delivered without the DC load-break switch.
11. **⚠ CAUTION**
Risk of burns due to hot enclosure parts
 - Wait 30 minutes before disassembling the inverter. This will allow the enclosure to cool down and thus prevent burn injuries.
12. Remove the inverter by lifting it vertically up and off the wall mounting bracket.

Commissioning the Replacement Device

NOTICE

Damage to seals on the enclosure lids in subfreezing conditions

If you open the upper and lower enclosure lids when temperatures are below freezing, the enclosure seals can be damaged. This can lead to moisture entering the inverter.

- Do not open the inverter at ambient temperatures lower than -5°C .
- If a layer of ice has formed on the seal of the lid when temperatures are below freezing, remove it prior to opening the enclosure lids of the inverter (e.g. by melting the ice with warm air). Observe the applicable safety regulations.

NOTICE

Damage to the inverter due to moisture and dust intrusion

Dust or moisture intrusion can damage the inverter and impair its functionality.

- Close all enclosure openings of the inverter tightly.
- Never open the inverter when it is raining or snowing, or the humidity is over 95%.

NOTICE**Damage to the inverter due to electrostatic discharge**

Touching electronic components can cause damage to or destroy the inverter through electrostatic discharge.

- Ground yourself before touching any component.

1. Mount the replacement device and make the electrical connections (see the operating manual of the inverter).
2. If needed, install interfaces in the replacement device and connect the interfaces (see the interface manual).
3. If needed, install a surge arrester in the replacement device (see Section 4 "Retrofitting the Surge Arrester Type II", page 12).
4. If there is a label with "transport lid" affixed to the upper lid of the replacement device, replace the upper enclosure lid of the replacement device with the upper enclosure lid of the defective inverter.

⚠ DANGER**Danger to life due to high voltages**

Wait 20 minutes before removing the upper enclosure lid to allow residual voltages to discharge.

- Loosen the screws of the upper enclosure lid using an Allen key (AF 4) and remove the enclosure lid.
- Position the upper enclosure lid with the six screws and conical spring washers on the enclosure and tighten it using an Allen key (AF 4) in the order 1 to 6 (torque: $6 \text{ Nm} \pm 0.3 \text{ Nm}$).

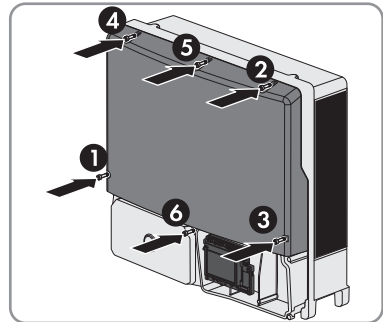

5. Insert the lower enclosure lid from above and flip it down. Use the enclosure lid of the defective inverter for this if there is a label with "transport lid" affixed to the enclosure lid of the replacement device. The screws must protrude from the lower enclosure lid.

6. Tighten all six screws in the lower enclosure lid with an Allen key (AF 3) in the order 1 to 6 (torque: $2 \text{ Nm} \pm 0.3 \text{ Nm}$). By tightening the screws in the prescribed order, you avoid warping the lid, which would keep it from sealing correctly.

Useful hint: If the screws fall out of the lower enclosure lid, insert the long screw into the lower middle hole and the five short screws into the other holes.

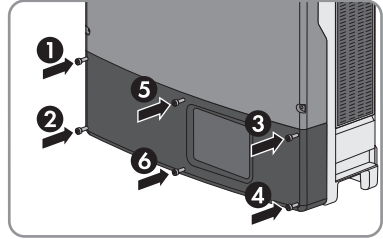

7. Recommission the replacement device (see Section 11, page 36). Remount the DC load-break switch of the defective inverter to the replacement device.
8. Configure the replacement device (see the operating manual of the inverter).
9. Replace the replacement device in the communication product.

Shipping the Defective Inverter

1. If necessary, position the upper enclosure lid with the six screws and conical spring washers on the enclosure and tighten it using an Allen key (AF 4) in the order 1 to 6 (torque: $6 \text{ Nm} \pm 0.3 \text{ Nm}$).

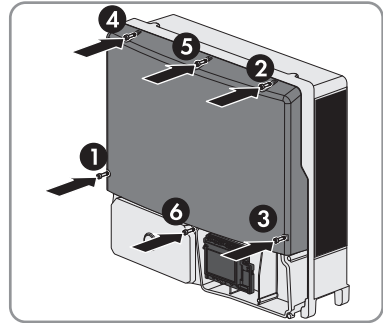

2. Insert the lower enclosure lid from above and flip it down. The screws must protrude from the lower enclosure lid.

3. Tighten all six screws in the lower enclosure lid with an Allen key (AF 3) in the order 1 to 6 (torque: $2 \text{ Nm} \pm 0.3 \text{ Nm}$). By tightening the screws in the prescribed order, you avoid warping the lid, which would keep it from sealing correctly.

Useful hint: If the screws fall out of the lower enclosure lid, insert the long screw into the lower middle hole and the five short screws into the other holes.

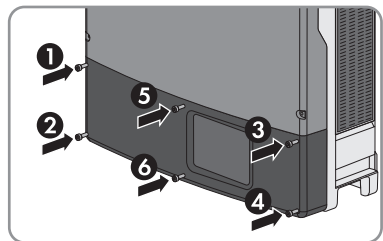

4. Pack the defective inverter in the packaging of the replacement device and arrange with SMA Solar Technology AG for it to be picked up.

13 Decommissioning the Inverter

To decommission the inverter completely upon completion of its service life, proceed as described in this Section. If the inverter is defective and you have received a replacement device, observe the information on how to proceed when receiving a replacement device (see Section 12 "Procedure for Receiving a Replacement Device", page 39).

⚠ CAUTION

Risk of injury when lifting the inverter, or if it is dropped

The inverter weighs 61 kg. There is risk of injury if the inverter is lifted incorrectly or dropped while being transported or when attaching it to or removing it from the wall mounting bracket.

- Carry and lift the inverter in an upright position with several people without tilting it. With one hand grasp the recessed grip, and with the other hand support the top part of the enclosure. This will prevent the inverter tipping forward.
- If the inverter is to be transported and lifted with a crane, remove the filler plugs on the top of the inverter and screw the eye bolts into the threads.

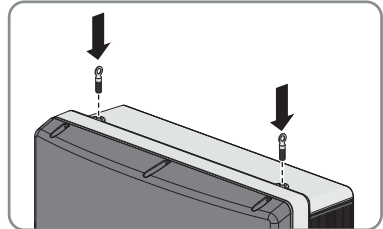
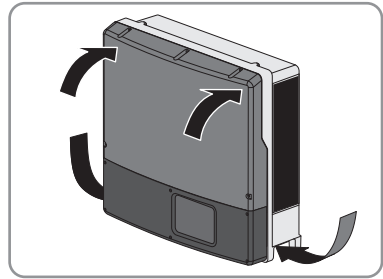

Procedure:

1. ⚠ DANGER

Danger to life due to high voltages

- Disconnect the inverter from all voltage sources (see Section 2.2, page 7).
2. Remove the AC cable from the inverter. Press the locking levers all the way upward and pull the conductors out of the connecting terminal plate for the AC cable.
 3. Press down the locking levers of the connecting terminal plate for the AC cable.
 4. If the multi-function relay or the SMA Power Control Module are used, remove the connection cable from the inverter.
 5. If other cables (e.g. data cables or network cables) are connected, remove them from the inverter.

6. Insert the lower enclosure lid from above and flip it down. The screws must protrude from the lower enclosure lid.

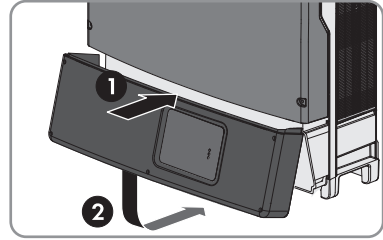

7. Tighten all six screws with an Allen key (AF 3) in the order 1 to 6 (torque: $2.0 \text{ Nm} \pm 0.3 \text{ Nm}$). By tightening the screws in the prescribed order, you avoid warping the lid, which would keep it from sealing correctly.

Useful hint: If the screws fall out of the lower enclosure lid, insert the long screw into the lower middle hole and the five short screws into the other holes.

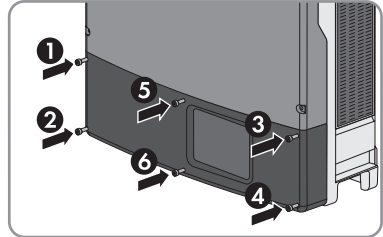

8. **⚠ CAUTION**

Risk of burns due to hot enclosure parts

- Wait 30 minutes for the enclosure to cool down.

9. If the inverter is protected from being lifted off, unscrew the screws out of the lower drill holes in the rear panel of the inverter.
10. Remove the inverter by lifting it up and off the wall mounting bracket.
11. If the inverter is to be stored or shipped in packaging, pack the inverter, the wall mounting bracket and, if applicable, the DC load-break switch. Use the original packaging or packaging that is suitable for the weight and dimensions of the inverter.
12. Dispose of the inverter in accordance with the locally applicable disposal regulations for electronic waste.

14 Spare Parts

You will find the spare parts for your product in the following overview. If required, these can be ordered from SMA Solar Technology AG or your distributor.

Designation	Brief description	SMA order number
Surge arrester type II	Type II surge arrester for input A and input B	DC_SPD_KIT3-10
SUNCLIX DC connector	Field plug for conductor cross-sections of 2.5 mm ² to 6 mm ²	SUNCLIX-FC6-SET
Ventilation grid	Ventilation grid set (right and left) as spare part	45-10899080

15 Contact

If you have technical problems with our products, please contact the SMA Service Line. We require the following information in order to provide you with the necessary assistance:

- Inverter device type
- Inverter serial number
- Inverter firmware version
- Special country-specific settings of the inverter (if applicable)
- Type and number of PV modules connected
- Mounting location and altitude of the inverter
- Inverter message
- Optional equipment, e.g. communication products
- If necessary, system name in the Sunny Portal
- If necessary, access data in the Sunny Portal
- Operating mode of the multifunction relay (if present)

Danmark	SMA Solar Technology AG	Belgien	SMA Benelux BVBA/SPRL
Deutschland	Niestetal	Belgique	Mechelen
Österreich	SMA Online Service Center:	België	+32 15 286 730
Schweiz	www.SMA-Service.com	Luxemburg	
	Sunny Boy, Sunny Mini Central, Sunny Tripower: +49 561 9522-1499	Luxembourg	
	Monitoring Systems (Kommunikationsprodukte): +49 561 9522-2499	Nederland	
	Fuel Save Controller (PV-Diesel-Hybridsysteme): +49 561 9522-3199	Česko	SMA Service Partner TERMS a.s.
	Sunny Island, Sunny Boy Storage, Sunny Backup, Hydro Boy: +49 561 9522-399	Magyarország	+420 387 6 85 111
	Sunny Central: +49 561 9522-299	Slovensko	
France	SMA France S.A.S. Lyon +33 472 22 97 00	Polska	SMA Polska +48 12 283 06 66
		Ελλάδα	SMA Hellas AE
		Κύπρος	Αθήνα +30 210 9856666

España Portugal	SMA Ibérica Tecnología Solar, S.L.U. Barcelona +34 935 63 50 99	United King- dom	SMA Solar UK Ltd. Milton Keynes +44 1908 304899
Bulgaria Italia România	SMA Italia S.r.l. Milano +39 02 8934-7299		
United Arab Emirates	SMA Middle East LLC Abu Dhabi +971 2234 6177	India	SMA Solar India Pvt. Ltd. Mumbai +91 22 61713888
ไทย	SMA Solar (Thailand) Co., Ltd. กรุงเทพฯ +66 2 670 6999	대한민국	SMA Technology Korea Co., Ltd. 서울 +82-2-520-2666
South Africa	SMA Solar Technology South Africa Pty Ltd. Cape Town 08600SUNNY (08600 78669) International: +27 (0)21 826 0600	Argentina Brasil Chile Perú	SMA South America SPA Santiago +562 2820 2101
Australia	SMA Australia Pty Ltd. Sydney Toll free for Australia: 1800 SMA AUS (1800 762 287) International: +61 2 9491 4200	Other countries	International SMA Service Line Niestetal 00800 SMA SERVICE (+800 762 7378423)

