

Hybrid 10k solar inverter

Service manual

Table of contents

1.	General information	3
1.1	Getting start	3
1.2	Important safety instructions	3
2.	Introduction of the inverter.....	4
2.1	Basic information	4
2.2	Functional topology	4
2.3	Main board	5
2.4	DC-DC board.....	6
2.5	SPS board.....	7
2.6	PV EMI board	7
2.7	CNTL board	7
2.8	Relay board.....	8
2.9	Grid board	8
2.10	OP board.....	8
3.	Trouble shooting	9
3.1	Check the fault information.....	9
3.2	Check the PCBs.....	17
4.	Appendix	35
4.1	PCBs replacement guideline.....	35
4.2	Signal cables connection guideline.....	44

1. General information

1.1 Getting start

This manual is for Hybrid 10k, it can help service personal perform the basic maintenance and repair service. This manual focus on the service, so you should get the basic operation of the inverter from the user manual, and make sure you had read and understood user manual before you use this service manual.

The manual include 4 sections, as follows

- General Information, this section showed the general information of the service manual.
- Introduction of the inverter and each PCB, this section shows you all the PCBs of the Hybrid 10k.
- Trouble shooting, this section will give you the way to find the trouble
- Appendix, this section showed the information of the critical parts, and how to replace the boards of the inverter.

1.2 Important safety instructions



WARNING: This chapter contains important safety and operating instructions.

1. Before repair the unit, please read this manual carefully.
2. To reduce risk of electric shock, disconnect all wirings before attempting any maintenance. Only turning off the unit will not reduce this risk.
3. Be very cautious when working with metal tools on or around batteries. A potential risk exists to drop a tool to spark or short circuit batteries or other electrical parts and could cause an explosion.
4. **Warning!!** Only qualified service persons are able to service this device.

2. Introduction of the inverter

2.1 Basic information

This chapter will introduce the topology and each board of the inverter; it will give us the basic impression of the inverter.

2.2 Functional topology

The topology of the inverter shows as below:

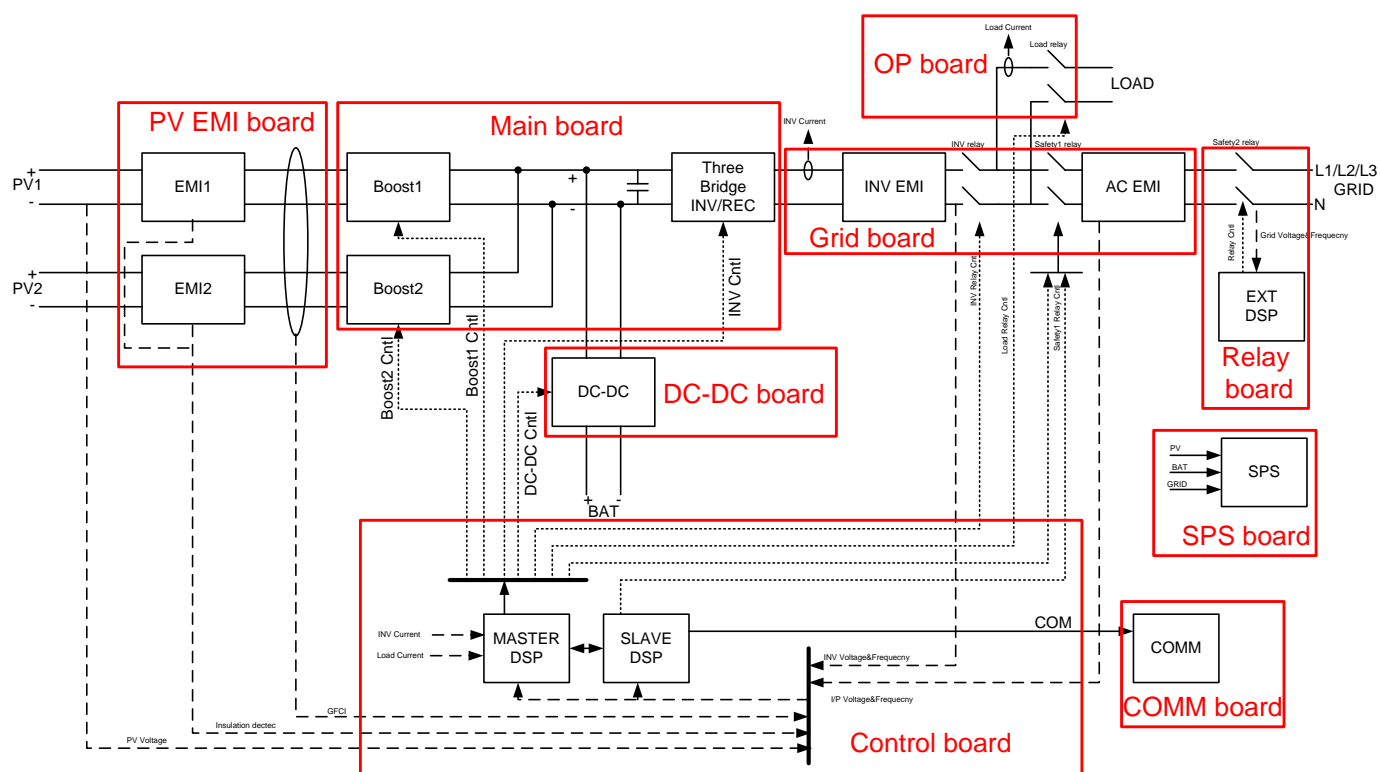

There are four factors of the inverter: PV, battery, grid and load. PV and load is the single direction, PV only uses for input, and load for output. Batter and grid is the bi-direction, cause the battery can be charged and also can discharge, grid can be input and output. With these factors, we can make several combinations to meet every application, maximum the availability of the power system.

2.3 Main board

The main board contains the Boost1, Boost2 and INV/REC module. Boost module takes in charge of MPPT from solar. It transfers the energy from the solar to the BUS. INV/REC module, just as its name implies, it can invert the energy from the BUS to grid or load; also it can convert the energy from the grid to the BUS.

The figure shows as below, and relevant modules are marked in red box.

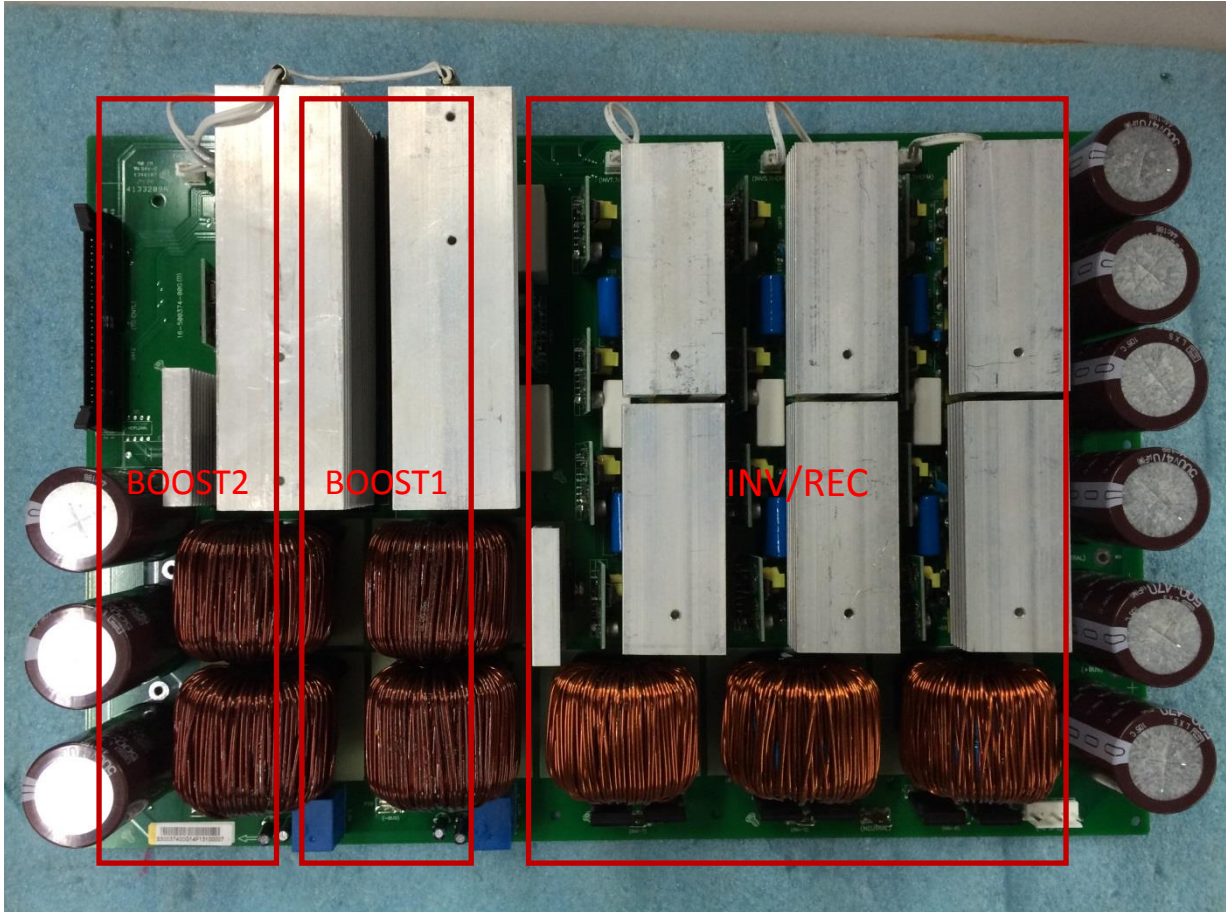

The topology of the main board:

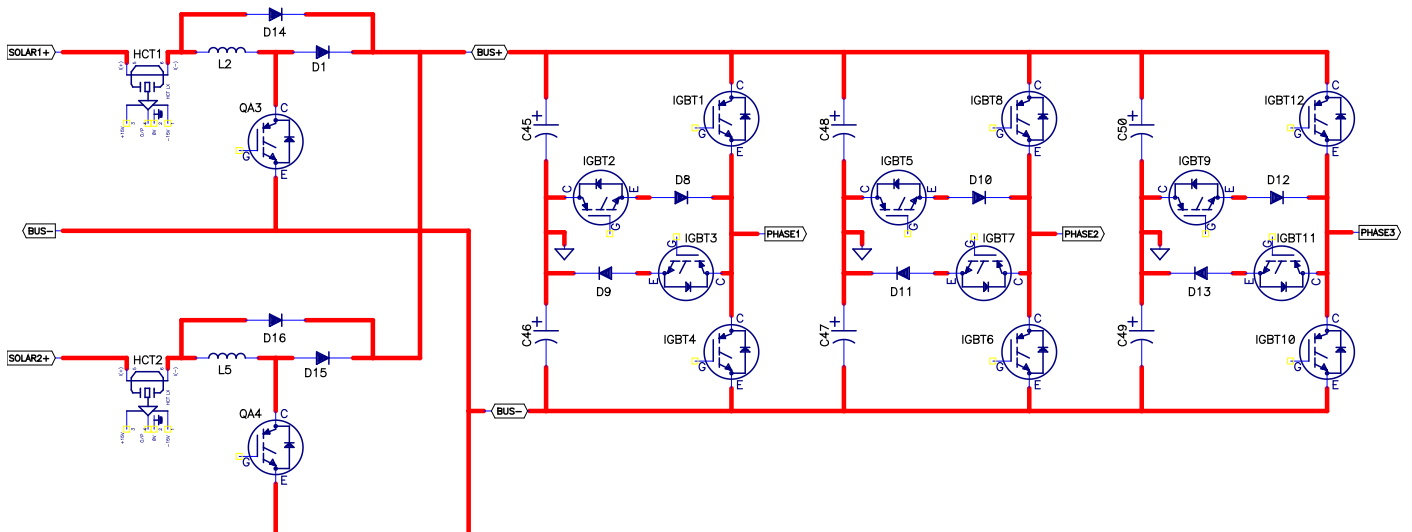

2.4 DC-DC board

DC-DC board only contains DC-DC module, the energy flows through this module between BUS and battery. When the battery discharges, the energy flows from battery to BUS. When the battery is being charged, the energy flows from BUS to battery. On the board, there are two symmetrical DC-DC module, each one supports 5KW.

The figure shows as below, and relevant modules are marked in red box.

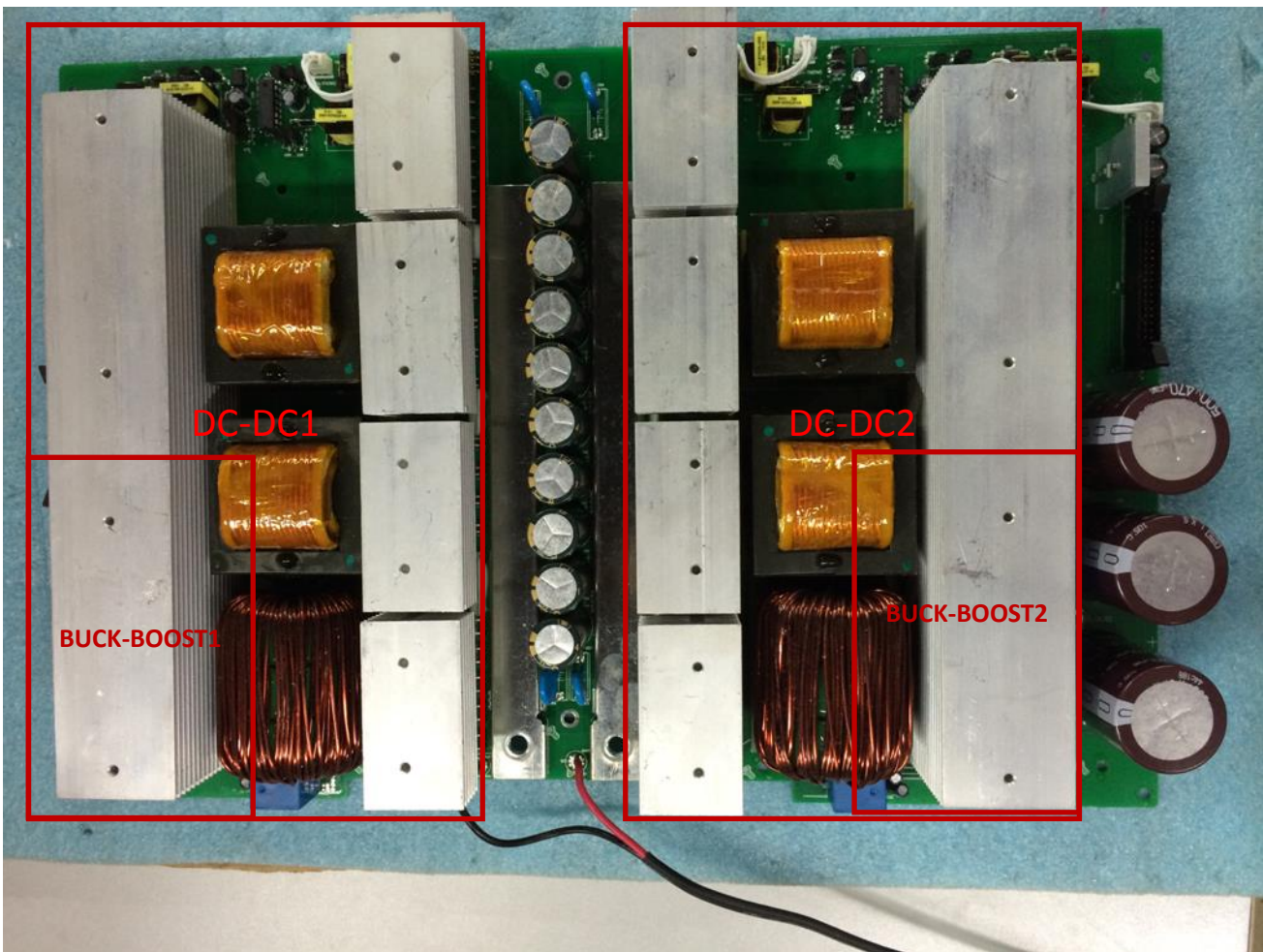

The topology of the DC-DC board:

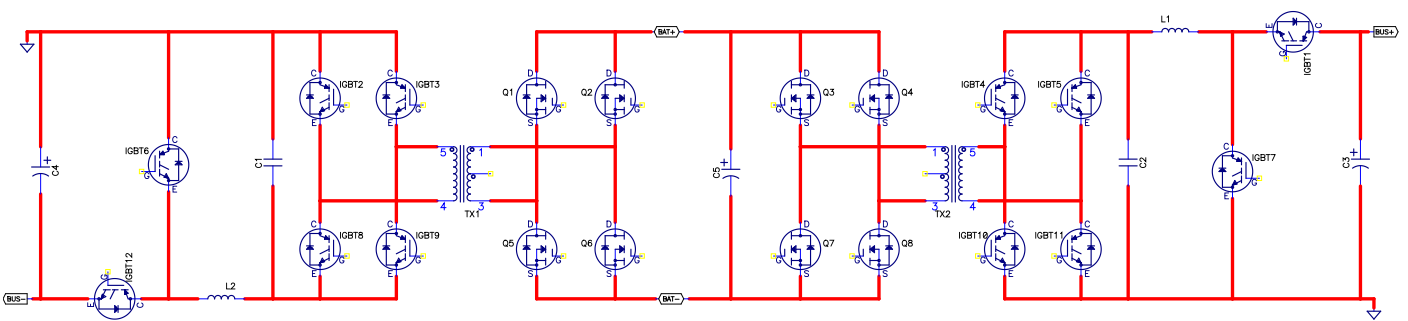

2.5 SPS board

SPS is the acronym of the switching power supply; it contains PV SPS, grid SPS and battery SPS which means that the inverter can be powered on by either of them.

The figure shows as below, and relevant modules are marked in red box.



2.6 PV EMI board

PV EMI board provides the EMI solution at the PV side; moreover it integrates the PV ISO detection and GFCI module. GFCI is used for detecting the leakage current from solar to grid, it's required by IEC 62109-2.

The figure shows as below, and relevant modules are marked in red box.

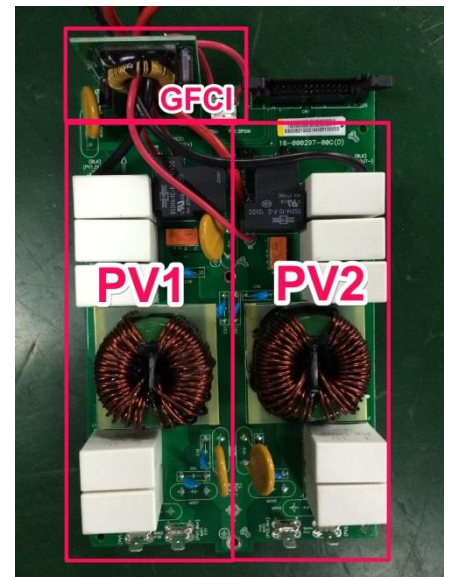

2.7 CNTL board

Control board provides the digital control of the inverter. It takes the signals from the kinds of sensors, and processes them in CPU, and then issues the commands to each module of the whole inverter.

There are two CPU on the board, one is the master and the other is slave. Actually it doesn't mean that the slave must follow the master, it's just the different division of the task. The master CPU takes in charge of the main control of the power module like DC-DC and REC/INV, and the slave CPU takes in charge of the control of Boost, display and communication. They both detect some important signals, and the relevant command needs the permission of both.

The figure shows as below, and relevant modules are marked in red.

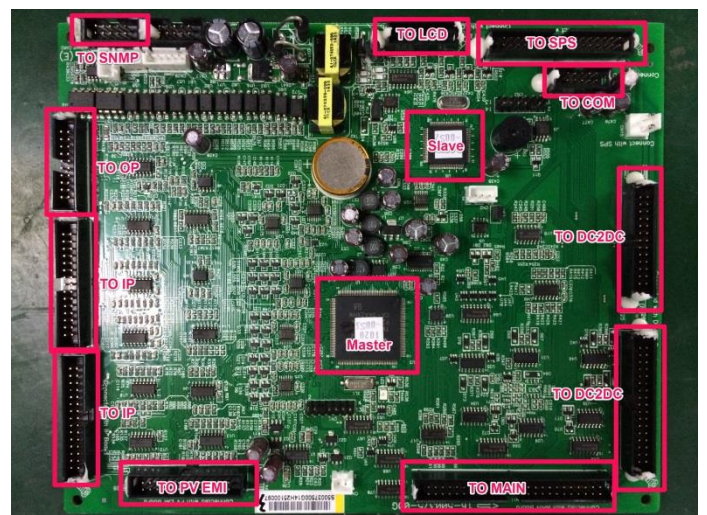

2.8 Relay board

Relay board uses as a NS protection which is required by the VDE-AR-N 4105.

2.9 Grid board

IP board includes the input relay and EMI solution at grid input.

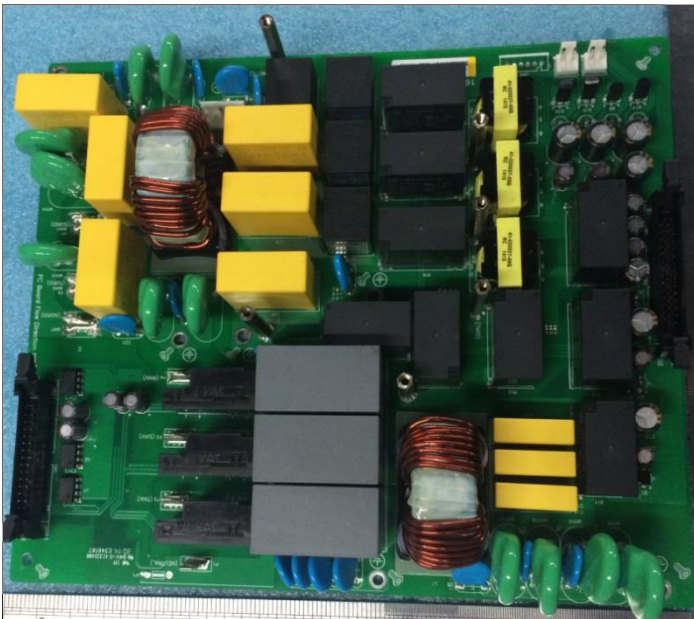
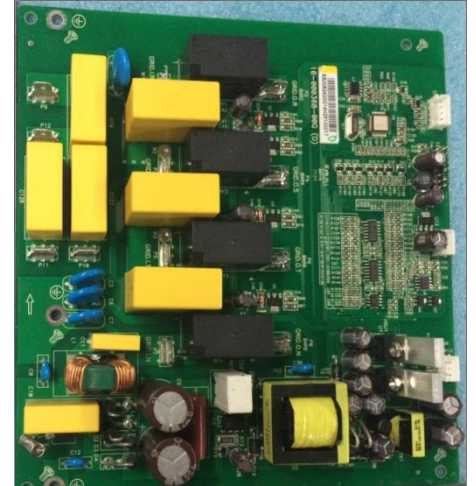

2.10 OP board

OP board includes the output relay and EMI solution at load side.

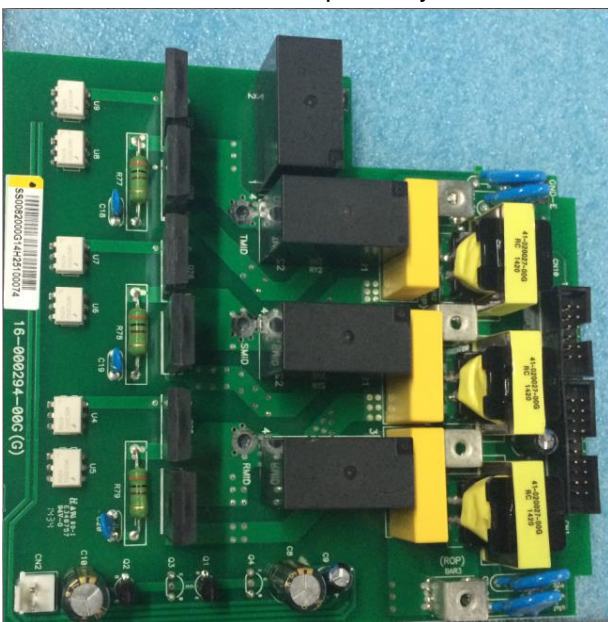

3. Trouble shooting

This section describes how to find the trouble when the system is abnormal. We suggest you can follow the service procedure:

- a. Check the system status by LCD display.
- b. Observe the failure board, static checking.
- c. Replace the failure board.
- e. Power up checking.
- f. Test after repair.

Following these sections will help service person to solve most of problem.

3.1 Check the fault information

Please follow the steps as below to find the issues!

Make sure that you can finish all the steps and feedback us the results. Or we may not be able to give you the right solution.

Step 1: Test the bypass mode.

Before turning on the inverter, only connect the utility with the inverter. Without press any buttons, the LCD will light up. Press the "ON" button for at least 3 seconds, and wait for the utility connecting to load.

If the connection is failed, please record the fault code.

Step 2: Test the battery working mode.

Before turning on the inverter, only connect the battery with the inverter which means no solar input and grid input.

Press the "ON" button for at least 3 seconds, the LCD will light up and wait for the battery connecting to load.

If the connection is failed, please record the fault code.

Step 3: Test the on-grid mode.

Before turning on the inverter, only connect the utility and solar with the inverter. Without press any buttons, the LCD will light up. And wait for the utility connecting to solar.

If the connection is failed, please record the fault code.

Step 4: Test the solar charging mode.

Before turning on the inverter, only connect the solar and battery with the inverter. Without press any buttons, the LCD will light up. And wait for the solar connecting to battery.

If the connection is failed, please record the fault code.

Note: The numbers with **ERROR** means fault code; with  means warning code. Please clarify them.

➤ **Error 01**

Error 01 means BUS voltage is over the limitation. Please disconnect the load, and restart the inverter to have a check.

If the inverter can work normally after the restarting, error 01 is usually caused by the surge from the utility input or the energy feedback from the load.

If the error persists, please check:

If the error 01 happens immediately when the LCD is on, usually this is the control board problem, you can change the control board to have a check.

If the error 01 happens when the output is available or charging, the possible cause is the DC-DC or main board, please contact with us to do the diagnose together.

➤ **Error 02**

Error 02 means BUS voltage is under the limitation. Please disconnect the load, and restart the inverter to have a check.

If the inverter can work normally after the restarting, error 02 is usually caused by the solar or load fluctuation.

If the error persists, the possible cause is the DC-DC board or control board.

➤ **Error 03**

Error 03 means BUS soft start is failed.

Before the inverter turns on the output or starts charging, the SPS board will charge the BUS capacitors to 700~800V, and then the DC-DC board will be activated, to keep the BUS voltage at 700~800V. If everything is OK, then the inverter will turn on the inverting module. If the voltage couldn't reach 700~800V or stay at this level, the error 03 will come out.

Error 03 is related to the main board, DC-DC board, SPS board and control board.

If you have the multimeter, it will help you to find out which board causes the error 03.

First, please find the BUS+, neutral and BUS- on the main board or DC-DC board, and follow the table as below to do the measurement.

Table 3.1

Red probe	Black probe	Test value	Reference values	Failure status
BUS+	Neutral	Diode voltage	OL	Less than 3V
Neutral	BUS+	Diode voltage	0.4~0.7V	Open or short
Neutral	BUS-	Diode voltage	OL	Less than 3V
BUS-	Neutral	Diode voltage	0.4~0.7V	Open or short

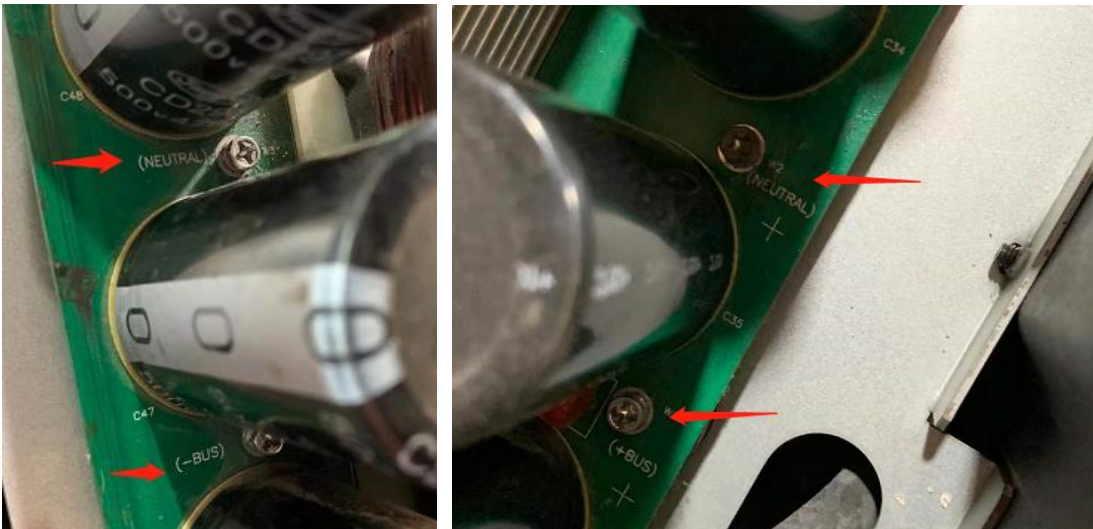

If the reading is right, and still error 03, it's usually the control board problem; you can change it and check again.

If the reading is not right, it means that the issue is among the main board, DC-DC board and SPS board. First, you can unplug this cable on the SPS board,

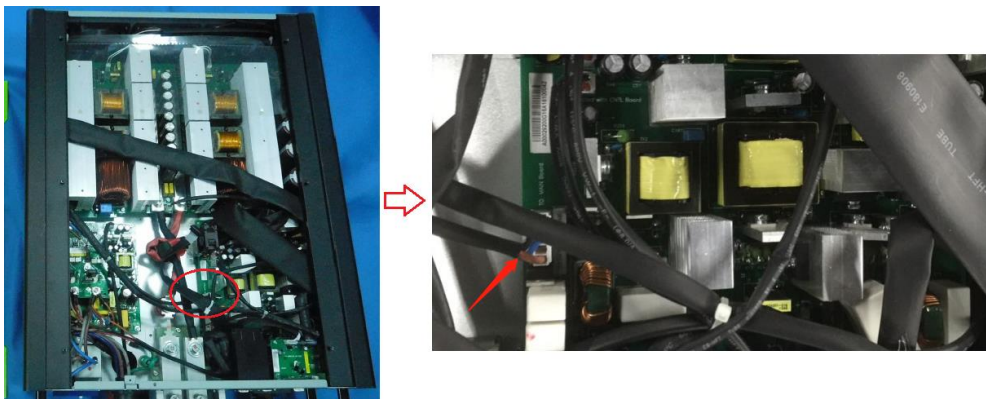

And then measure the diode voltage on the terminal CN7 of the SPS board by following table 3.1.

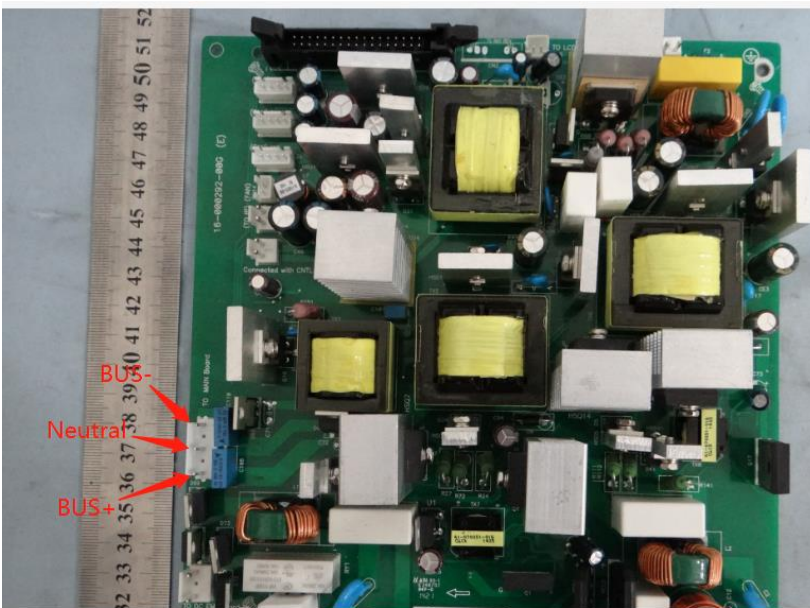

If the value is right, it means SPS board is good. You can check the main and DC-DC board.

Please replace the boards that with wrong values, error 03 will be solved.

➤ **Error 04**

Error 04 means inverting soft start is failed.

After bus soft start is finished, and DC-DC board is turned on. The controller will turn on the inverting module, it will output the voltage from 0V to 230V (phase to neutral). If the voltage couldn't reach 230V after a time, the inverter will give error 04.

Error 04 is related to the main board, and control board.

Please replace the control board and main board both, it will solve error 04.

➤ **Error 05**

Error 05 means inverting current is over the limitation. Please disconnect the load, and restart the inverter to have a check.

If the inverter can work normally after the restarting, error 05 is usually caused by the surge from the utility input or the energy feedback from the load.

If the error persists, please check:

If the error 05 happens immediately when the LCD is on, the problem is related with SPS board, control board, HCT board and parallel board.

If the error 05 happens when the output is available or charging, the problem is related with the main board, please replace it to have a check.

➤ **Error 06**

Error 06 means over temperature. Please disconnect the load, and restart the inverter to have a check.

If the error still persists even the inverter has cooled down, it means the temperature sensors are wrong.

We have the sensors on main board and DC-DC board. Please contact with us, we will provide a special firmware for you to diagnose which sensor is wrong.

➤ **Error 07**

Error 07 means relay checking fail. This error is usually caused by the rusting on the board which it is due to the dust and moisture.

This error is related to the grid board, HCT board, and relay board. Please change these boards, this error will be solved.

➤ **Error 08**

Error 08 means DC current sensors are wrong. We have DC current sensors on main and DC-DC boards.

You can contact with us for the special firmware, it will help to identify which sensor is wrong. Or you can follow as below to check which sensor is wrong.

Please find the terminals as below on the control board:



Unplug them, and put the jumper (Or use something to short them) on the terminal like as below:



Please turn on the inverter, and check if error 08 is solved. If there is no error 08, it means that the sensors on the DC-DC board are wrong, you can change the DC-DC board to solve this error.

Or the sensors on the main board are wrong, you can change the main board to solve this error.

If the error still persists after replacing the main board, please change the parallel card.

➤ Error 09

Error 09 means solar input power is not normal. Please restart the inverter to check.
This error is very rare to see, if you face this error, please contact with us.

➤ Error 11

Error 11 means solar input is over current. This error is very rare to see, if you face this error, please contact with us.

➤ Error 12

Error 12 means leakage current is over the limitation.

For our inverter is the transformerless type, it means there is no galvanic isolation between the solar and grid.

The loop of the leakage current will be like as below:

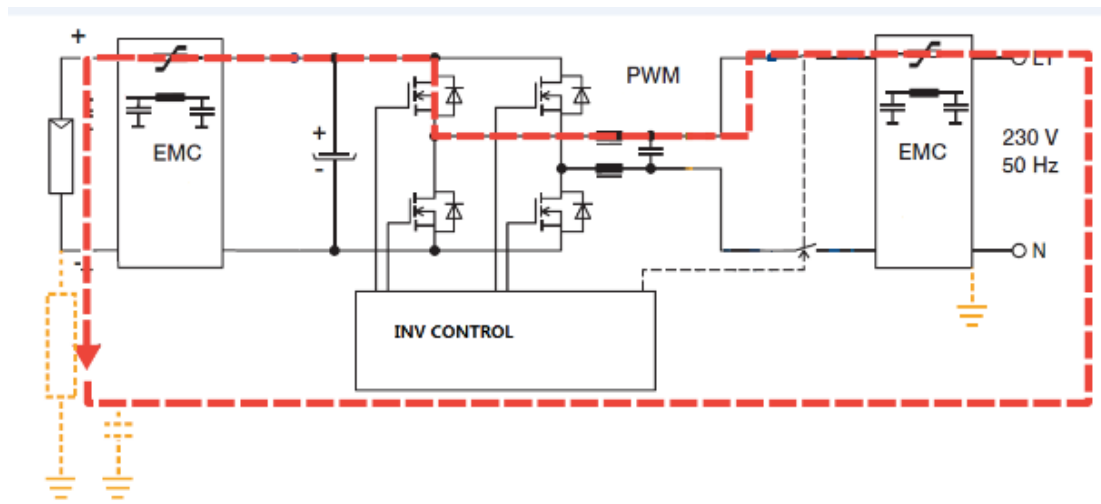

Generally the photovoltaic cells are isolated with the ground, but sometimes, it may have the isolation problem, like the cable is broken or sinking in the water, the glass of the panels has something wrong. These factors may cause leakage current from solar panels to ground.

By following the safety standard, the inverter needs to cut off the utility input if the current is over the limitation.

Please check the installation of the solar panels to solve this error.

If the error persists without solar panels connected, the sensor of the leakage current is failed; you can change the PV EMI board to solve it.

➤ Error 13

Error 13 means the isolated resistance of the solar panels is too low. If the error persists after you choose "Grid tie with backup" or "Off-grid mode", please contact with us.

➤ Error 14

Error 14 means the DC component of the output current is over the limitation when the grid is connected in. This error only happens when the grid is connected in.

If the error persists when you restart the inverter, the error is related to the main board or HCT board. You can change these boards to have a check.

➤ **Error 16**

Error 16 means the self-checking of the leakage current sensor is failed. Please replace the PV EMI board to solve the issue.

➤ **Error 22**

Error 22 means the battery voltage is too high. Please check the real voltage and the voltage showed in the LCD display.

If the voltage is higher than 60V, this error will happen.

➤ **Error 23**

Error 23 means the overload is activated.

Please check if some loads are too heavy for the inverter. Like air conditioner, pump and motors, this kind of loads demand large inrush current when they start up. The recommended rating of these loads is less than 1/3 rating of the inverter.

➤ **Error 26**

Error 26 means the output is shorted. It is usually caused by the load output connection is shorted.

Please check if the wire connection of the load is shorted, or the load is shorted by itself.

➤ **Error 27**

Error 27 means the fans are blocked. When this error happens, please check if there is any fan stop working.

Usually this error is caused by fans stop working. In few cases, it is caused by SPS board.

➤ **Error 32**

Error 32 means the DC component of the output voltage is over the limitation. This error only happens when the inverter is in battery mode.

Some loads like drier, they are half waveform consumer, and they will create the DC component on the voltage.

The recommended rating of these loads is less than 1/2 rating of the inverter.

➤ **Error 33**

Error 33 means the output voltage is lower than limitation. This error is similar with error 23.

➤ **Error 34**

Error 34 means the output voltage is too high. This error is similar with error 04.

➤ **Error 35**

Error 35 means the wire connection is not well. Please check the cables if they are tighten connected on the control board and the other boards connected with control board.

The cable shown in the figure will cause error 35.

➤ **Error 36**

This error has been canceled, if you have this error, please contact with us.

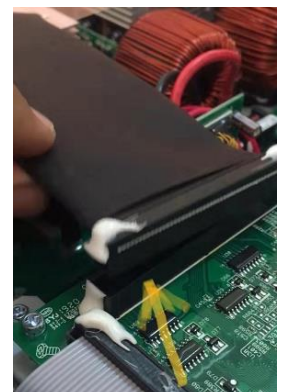

➤ **Error 37**

Error 37 means the current is over limitation on the input neutral.
If the error persists without any loads, please replace the relay board.

➤ **Error 60**

Error 60 means the power is not balance between each inverter which is working in parallel with each other.
Please disconnect the grid input, and check if the load percentage is the same in the LCD display of each inverter.

This error is usually caused by the parallel board.

➤ **Error 61 and 62**

Error 61 and 62 means relay board is failed, please change it to check.

➤ **Error 72**

Error 72 means the current sharing control is failed.

This error is related with parallel board, sometimes control board also.

When do parallel installation, please make sure that the output neutral of each inverter should be connected always, or it may cause error 72.

➤ **Error 80, 81 and 82**

Error 80~82 means parallel CAN communication is lost. Please change the parallel board.

3.2 Check the PCBs

In most situations, we need to take the PCBs out of the inverter and do some static measurement, then we can realize which part is damaged, and replace the relevant boards or components.

Most fault conditions are due to the damaged of the power board, including main board, DC-DC board, and sometimes SPS board.

3.2.1. Main board checking

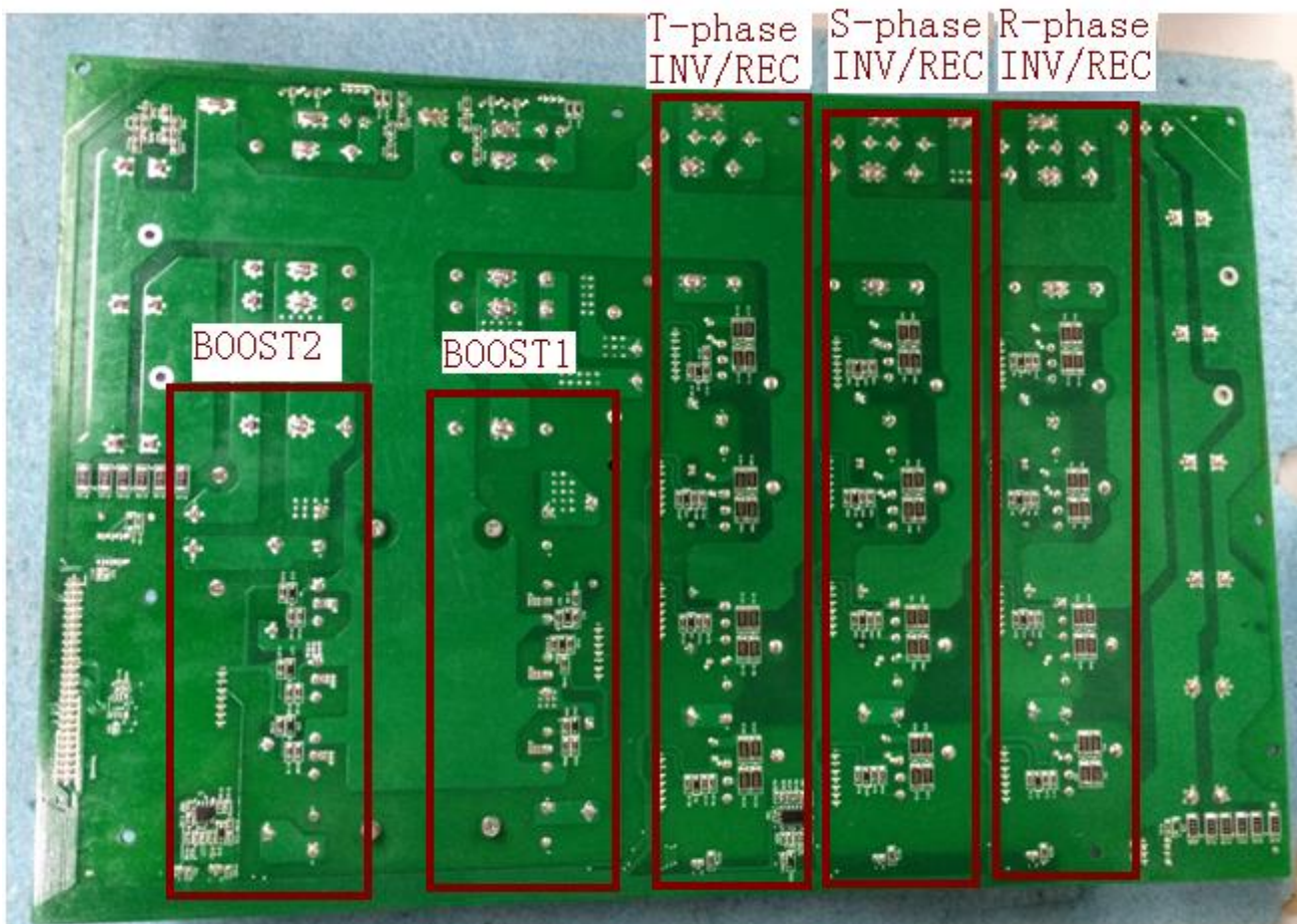

Step1: Check the BOOST module

BOOST1:Q3/Q4/Q5/D4/D6/D31

BOOST2:Q11/Q12/Q13/A12/D13/D40

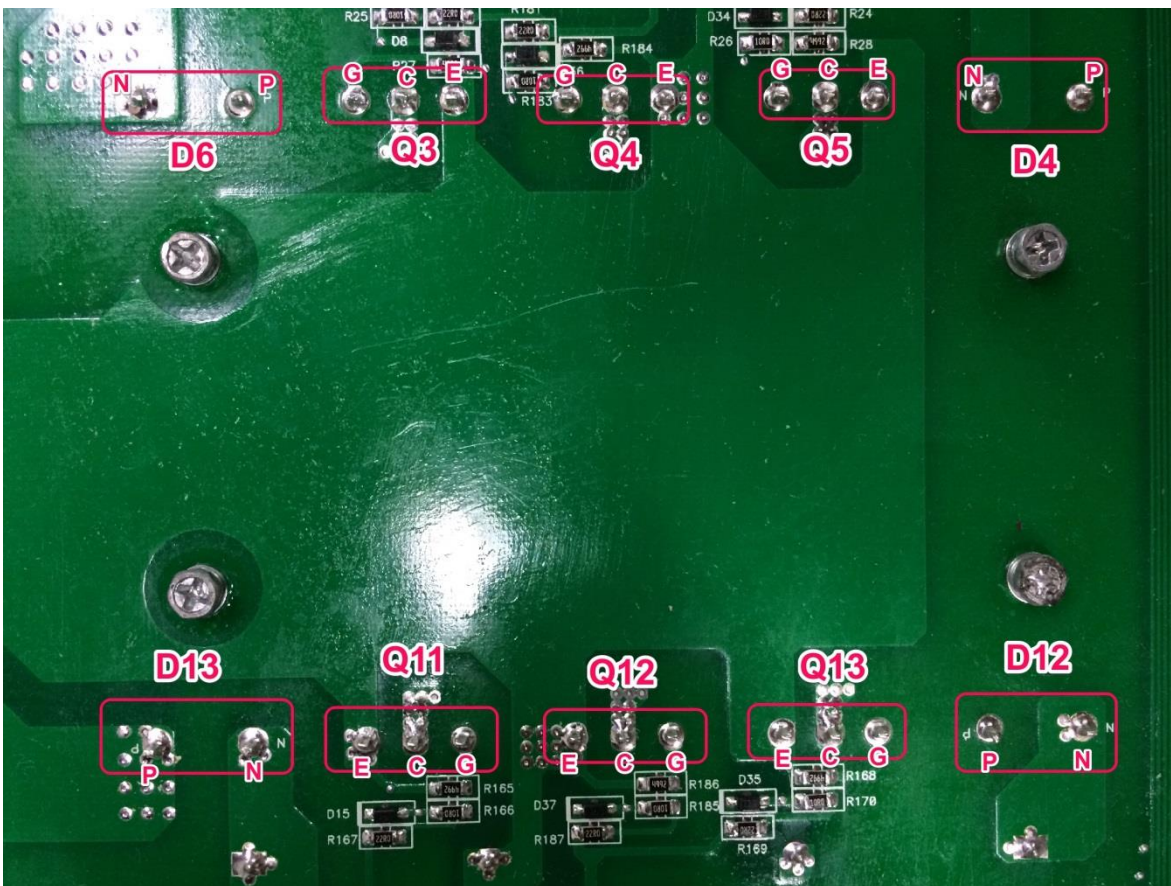
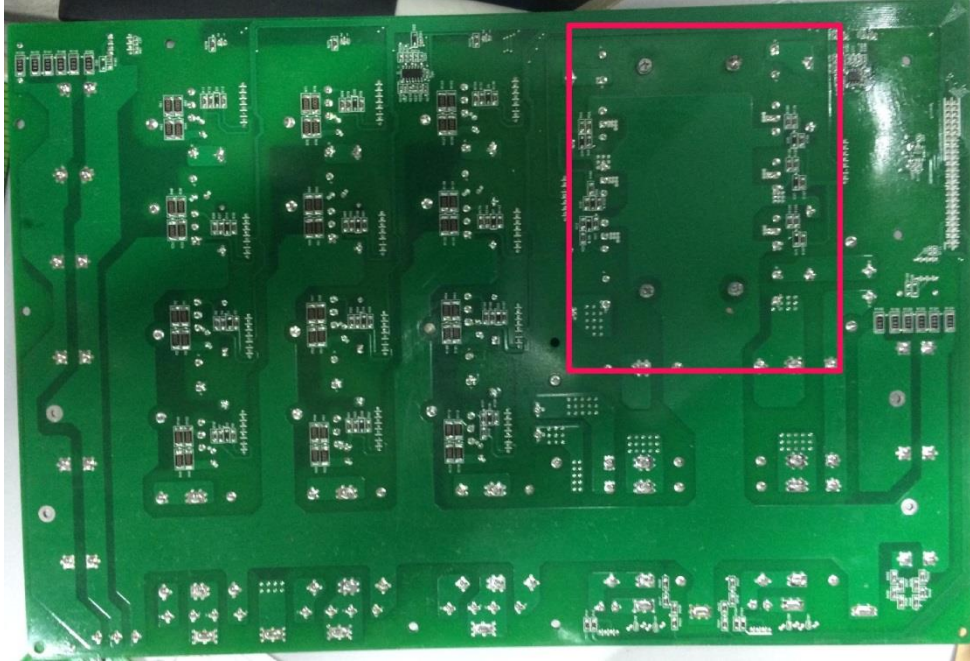

All of the IGBTs are 11-330086-00G(IGBT FC/FGH40T120SMD 40A 1200V NPT BULK TO-247)

All of the Diode are 11-200039-00G(D FAIRCHILD/RHRG75120 75A 1200V SFST RAD BULK)

Hybrid 10KW Service manual

Parts	Attribute	Reference values	Failure status
Q3/Q4/Q5 /Q11/Q12/Q13	Resistor	GE: 16.7k GC: 176k CE: 1M	Short or explosion
	Diode	CE: 0.4V EC: OL	
D4/D6/D31/D12/D13/D40	Diode	+ to -: 0.4V - to +: OL	Short or explosion

Step2: Check the INV/REC module

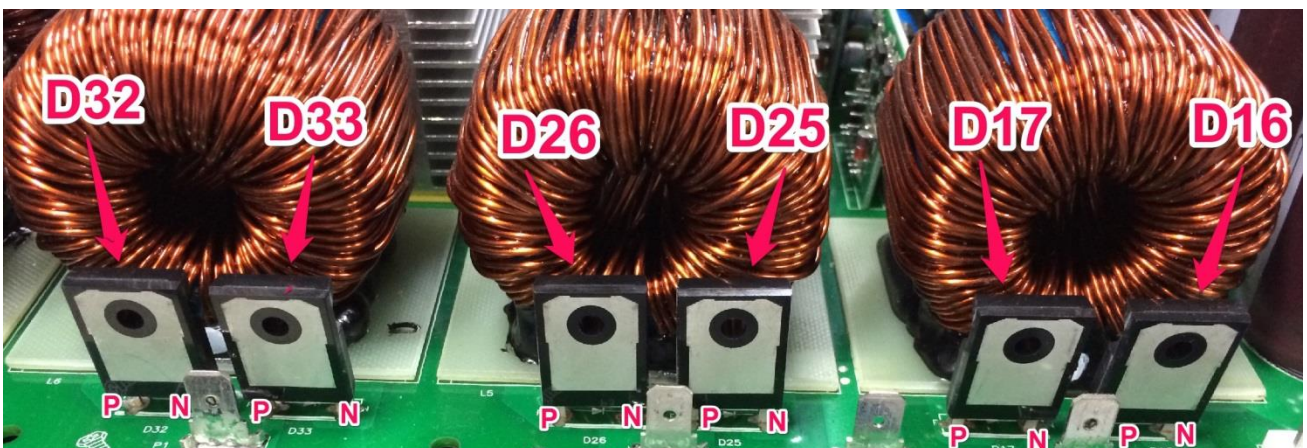

Hybrid 10KW Service manual

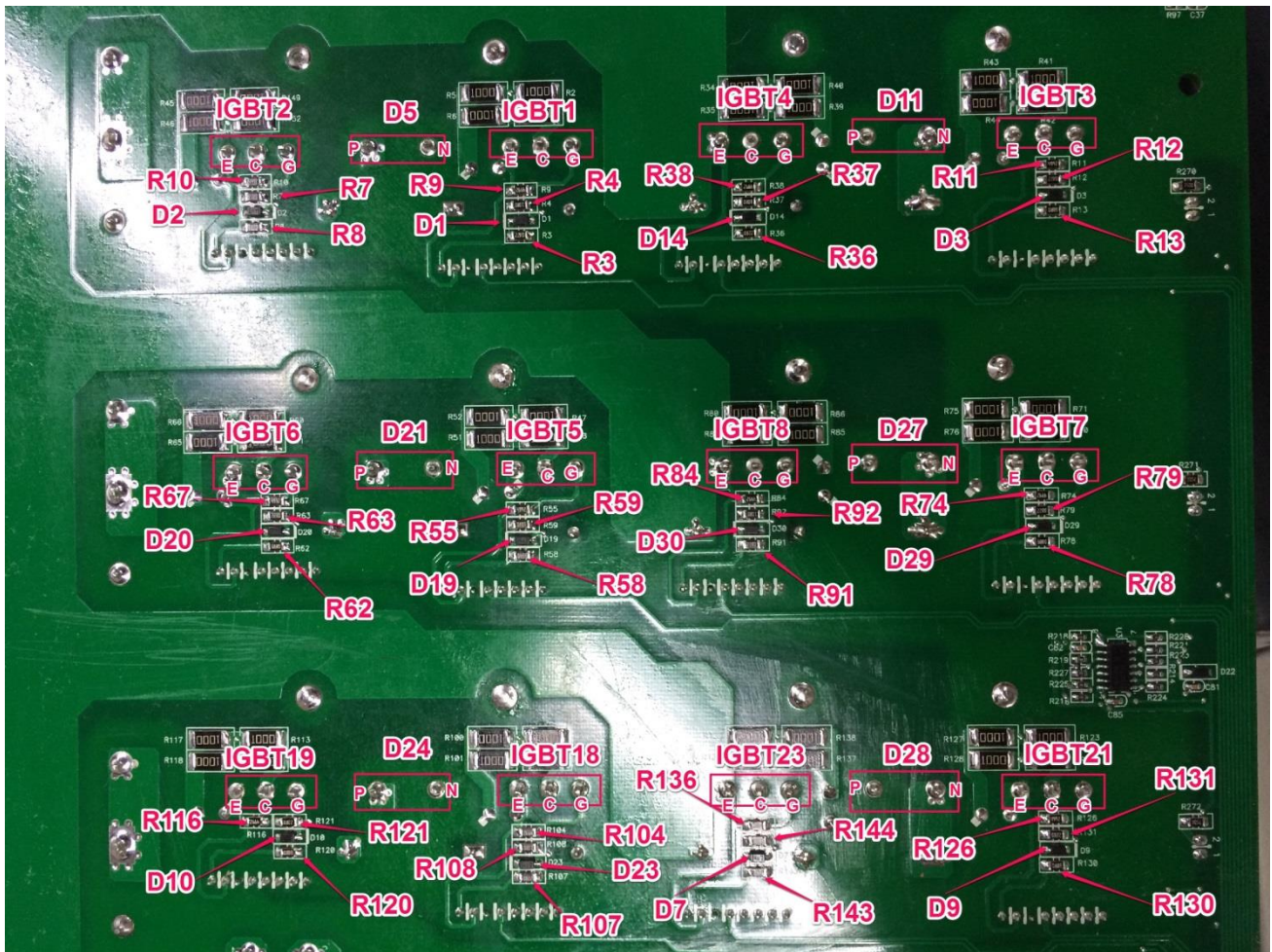

R-phase INV/REC: IGBT1/IGBT2/IGBT3/IGBT4/D5/D11/D16/D17
 S-phase INV/REC: IGBT5/IGBT6/IGBT7/IGBT8/D21/D25/D26/D27
 T-phase INV/REC: IGBT18/IGBT19/IGBT21/IGBT23/D24/D28/D32/D33

Parts	component	Attribute	Reference values	Failure status
IGBT1/IGBT4/IGBT5/IGBT8/IGBT18/IGBT23	FC/FGL40N120AND	Resistor	GE: 44k GC: 200k CE: 1M	Short or explosion
IGBT2/IGBT3/IGBT6/IGBT7/IGBT19/IGBT21	IR/IRGP4266DPBF		GE: 44k GC: 260k CE: OL	
D5/D11/D16/D17/D21/D25/D26/D27/D28/D32/D33	FAIRCHILD/RHRG75120	Diode	PN: 0.4V NP: OL	

3.2.2. DC-DC board checking

Step1: Check the battery side of the DC-DC system:

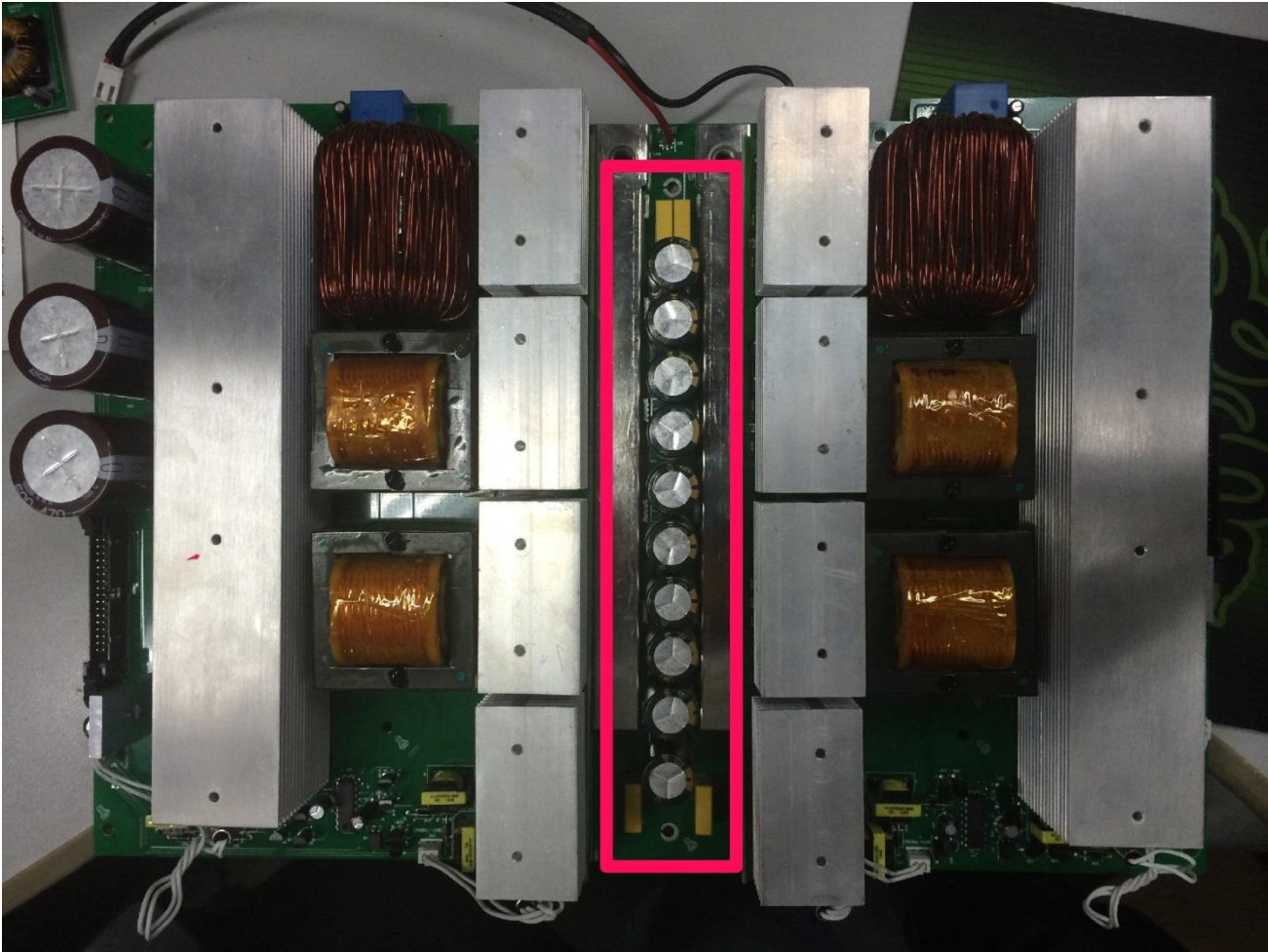

C13/C14/C15/C16/C17/C91/C92/C94/C95/C97: 15-000072-00G (C-AL 3300UF 63V M RAD BULK 7.5 105°C 18*45.5)

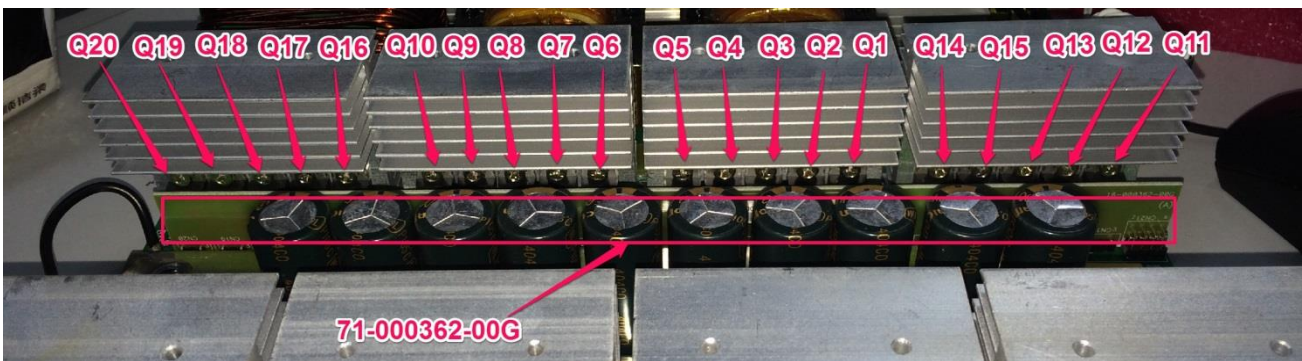
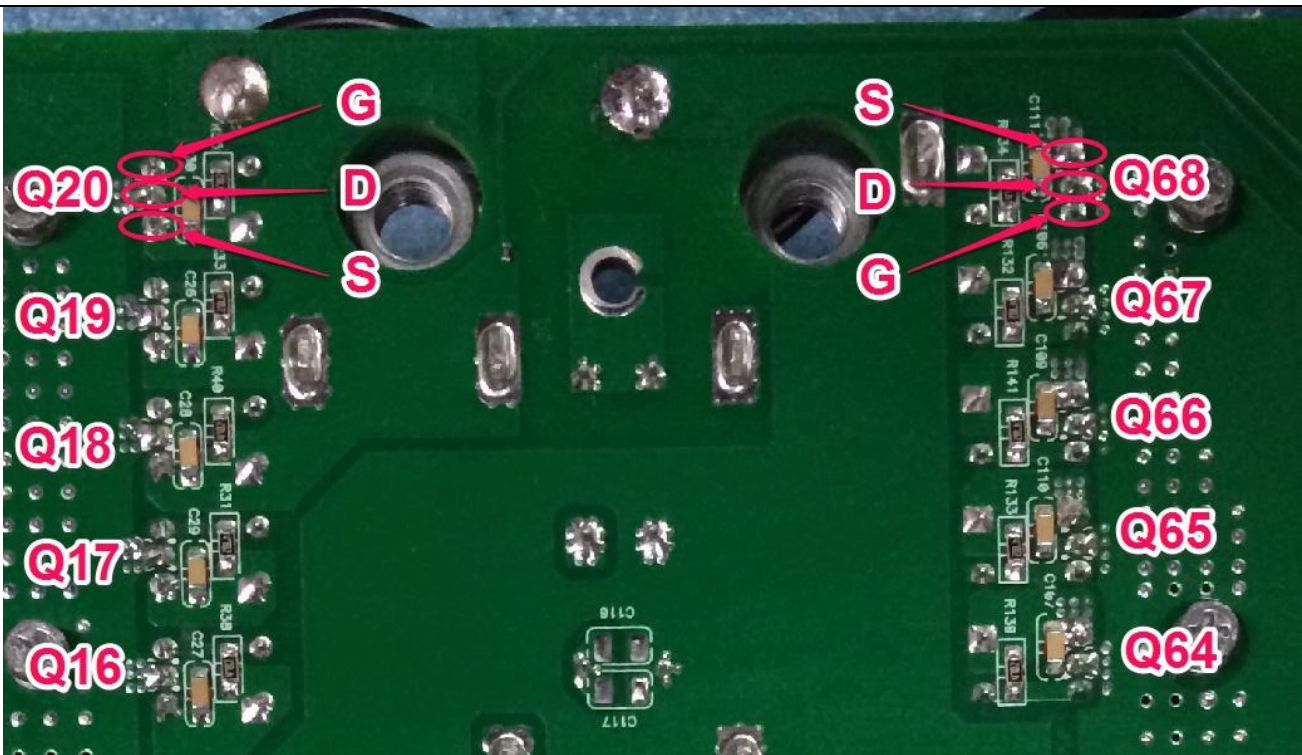

DC-DC1 MOSFET: Q1/Q2/Q3/Q4 /Q5& Q6/Q7/Q8/Q9/Q10 & Q11/Q12/Q13/Q14/Q15 & Q16/Q17/Q18/Q19/Q20

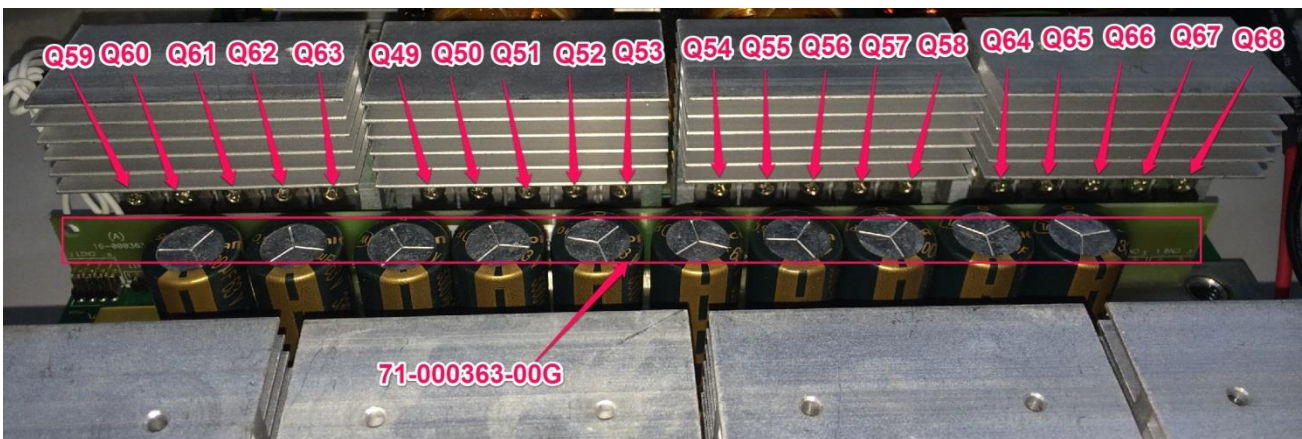

DC-DC2 MOSFET:

Q49/Q50/Q51/Q52/Q53/Q54/Q55/Q56/Q57/Q58/Q59/Q60/Q61/Q62/Q63/Q64/Q65/Q66/Q67/Q68

Hybrid 10KW Service manual

ALL of the mosfets are 11-320117-00G (MOSFET IR/IRFB3077 210A 75V N BULK TO-220)

Parts	Attribute	Reference values	Failure status
All: IRFB3077	Resistor ¹	GS: 9.4k GD: 230k DS: 2.4M	Short or explosion
	Diode	SD: 0.41V DS: OL	

Note1: When you use the multimeter to measure the resistor of the transistor, because of the capacitor in the circuit, it will cause the changing of the values when you measure the DS and GD. So we recommend you measure the diode forward voltage of SD, and the resistor of GS. These two values can reflect the situation of the transistor more correctly.

Step 2: Check the bus side of the DC-DC system:

DC/DC1 IGBT: Q23/Q24/Q27/Q28

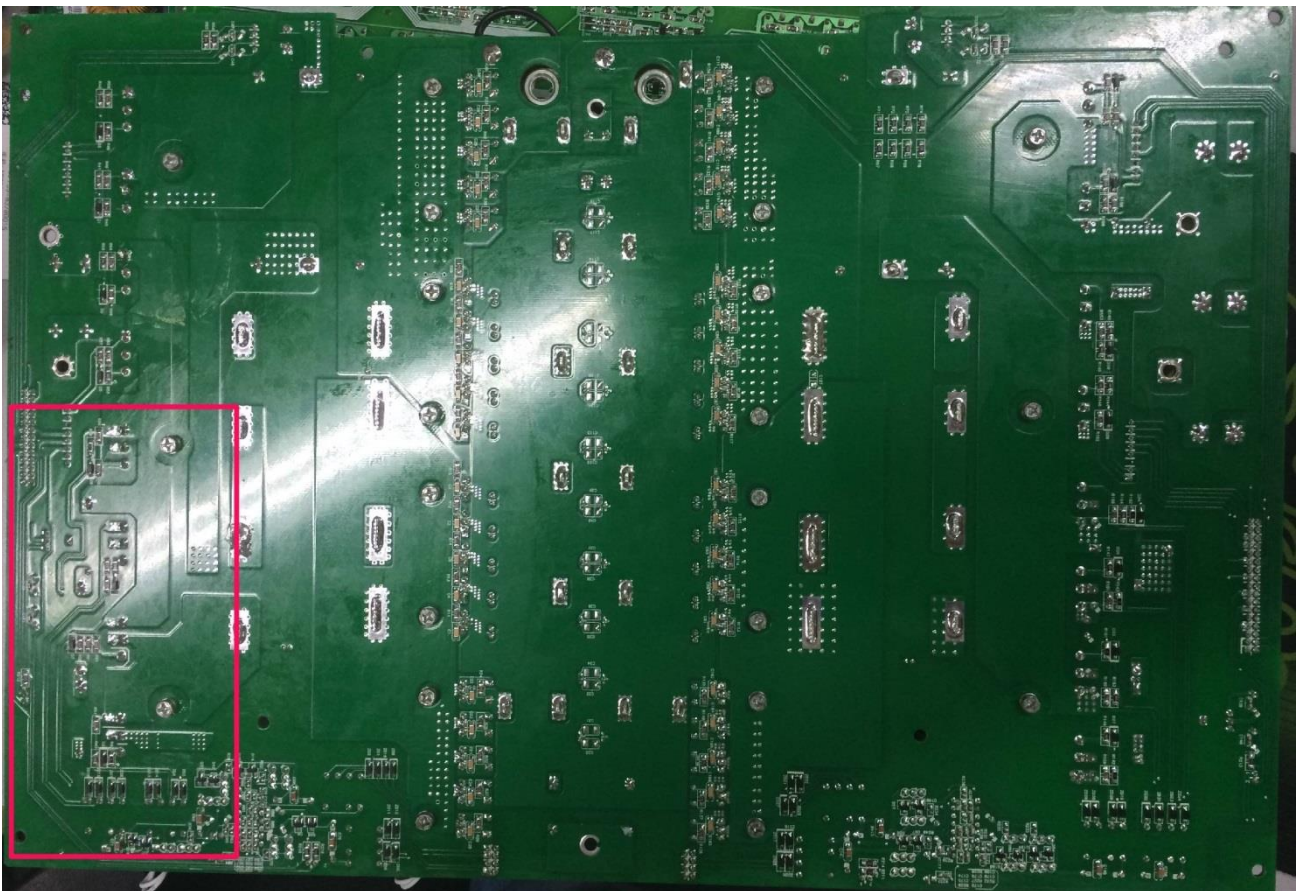

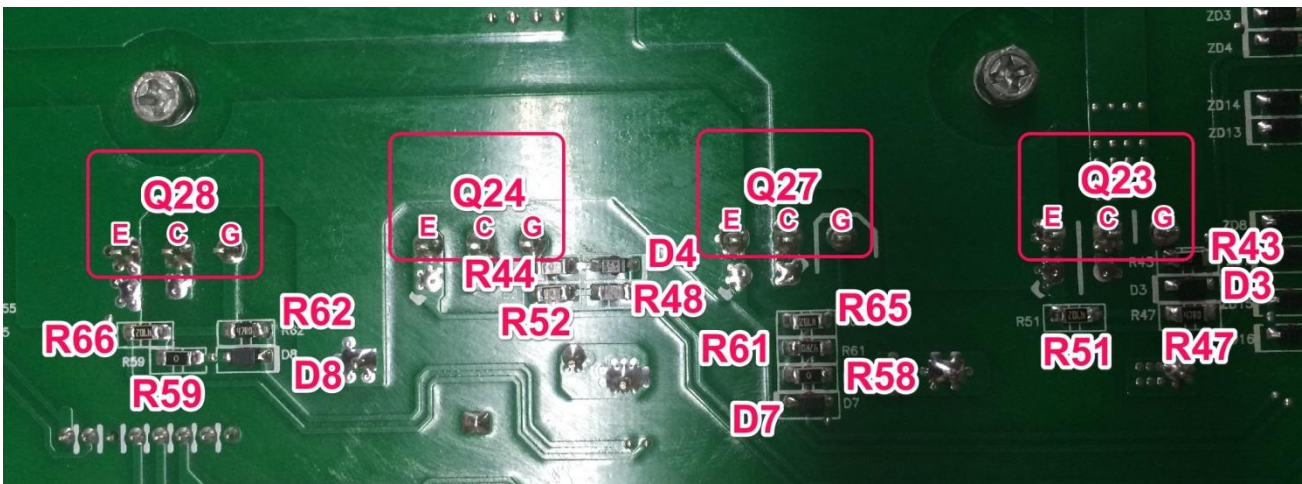

DC/DC2 IGBT: Q69/Q70/Q74/Q75

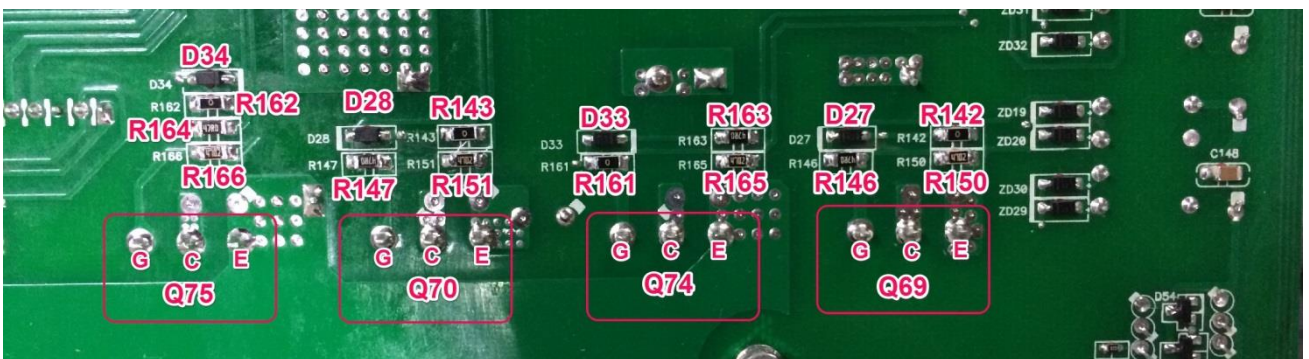
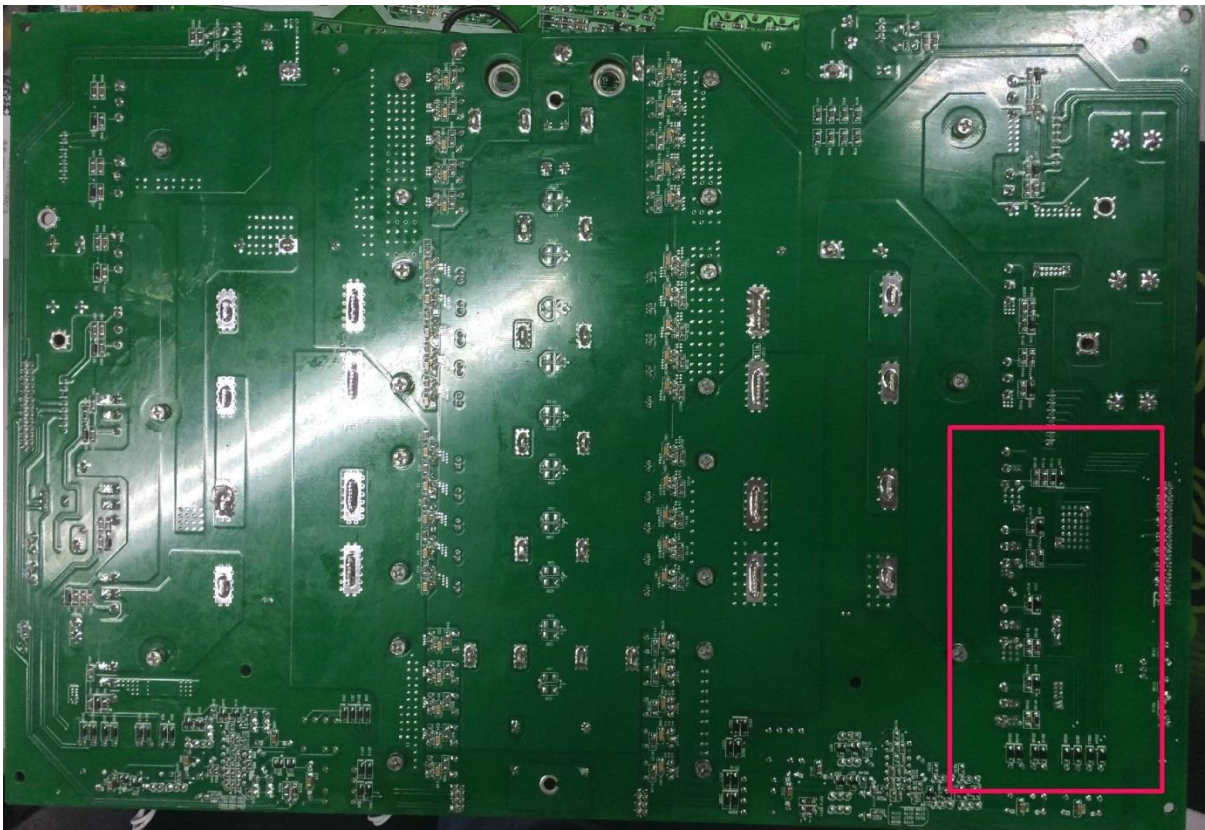

ALL of the IGBTs are 11-330087-00G (IGBT IR/IRGP4266DPBF 90A 650V N BULK TO-247)

Hybrid 10KW Service manual

Parts	Attribute	Reference values	Failure status
Q23/Q24/Q27/Q28 Q69/Q70/Q74/Q75	Resistor ¹	GE: 47 ohm GC: 190k CE: OL	Short or explosion
	Diode	EC: 0.38V CE: OL	

Step 3: Check the buck-boost circuit:

BUCK-BOOST1 IGBTs: Q21/Q22/Q25/Q26

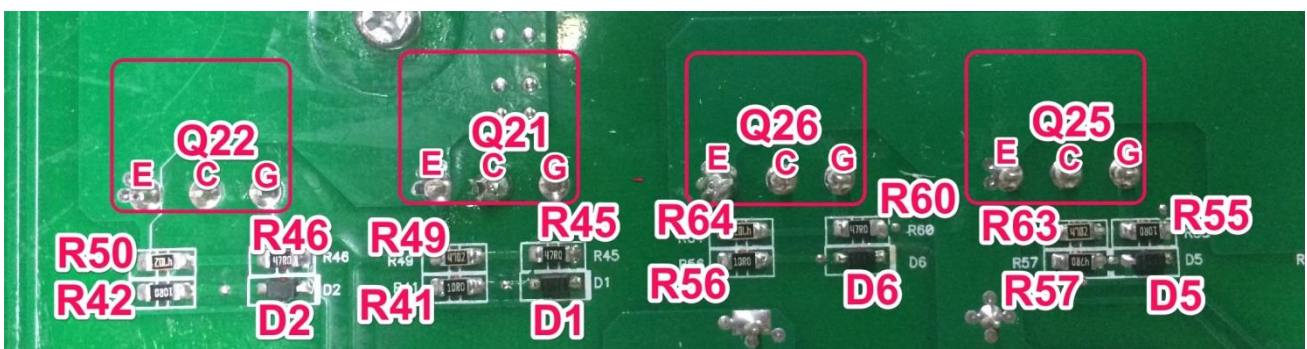
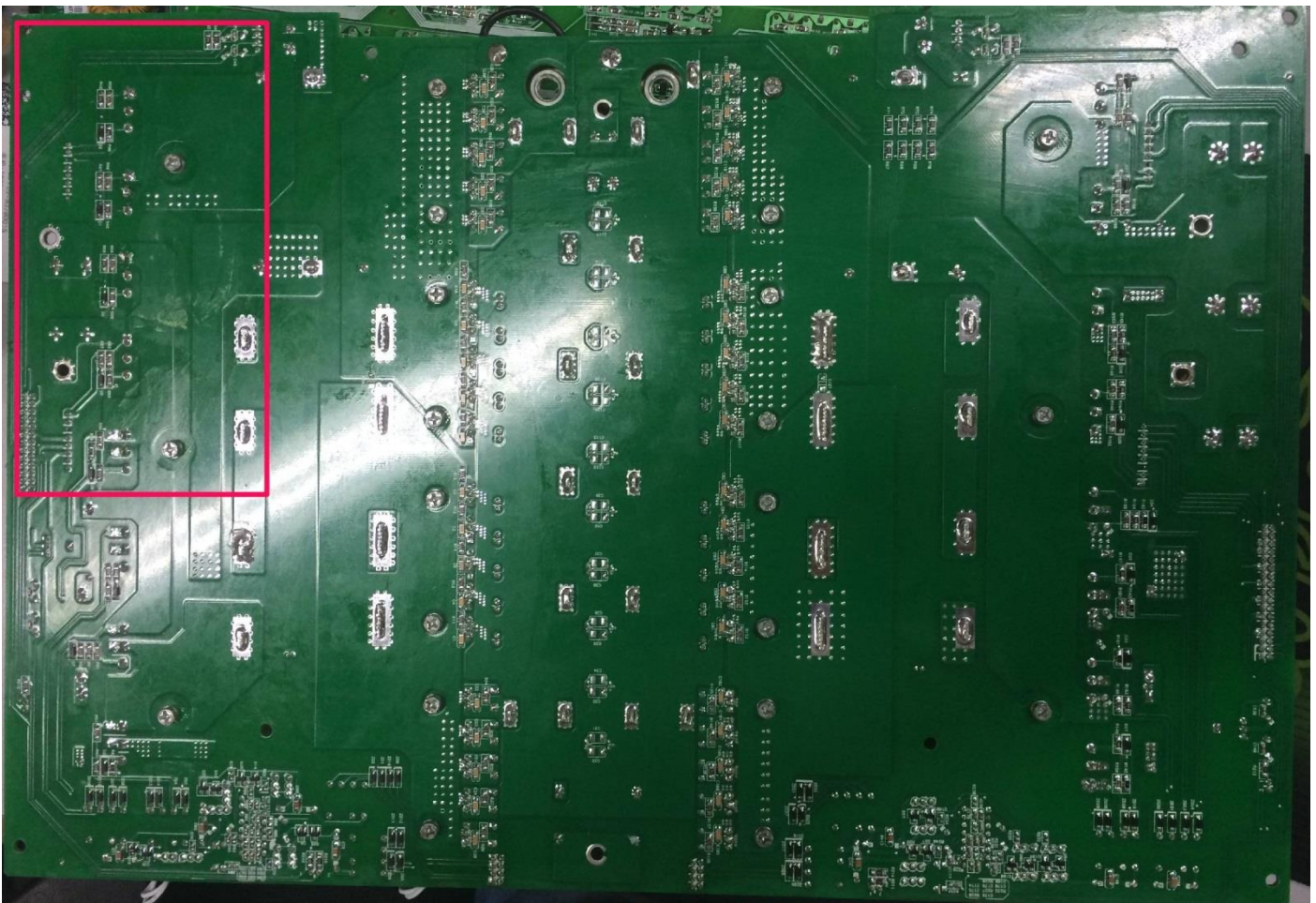

BUCK-BOOST2 IGBTs: Q71/Q72/Q73/Q76

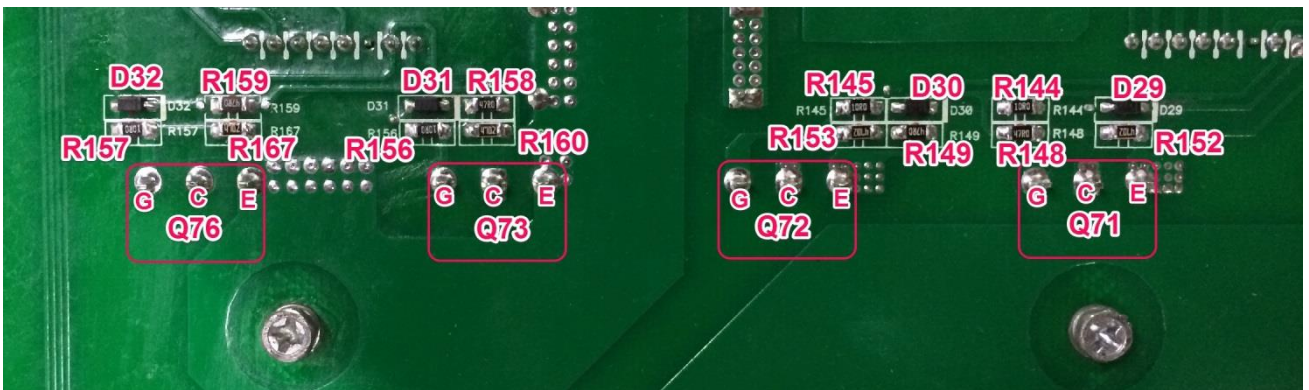
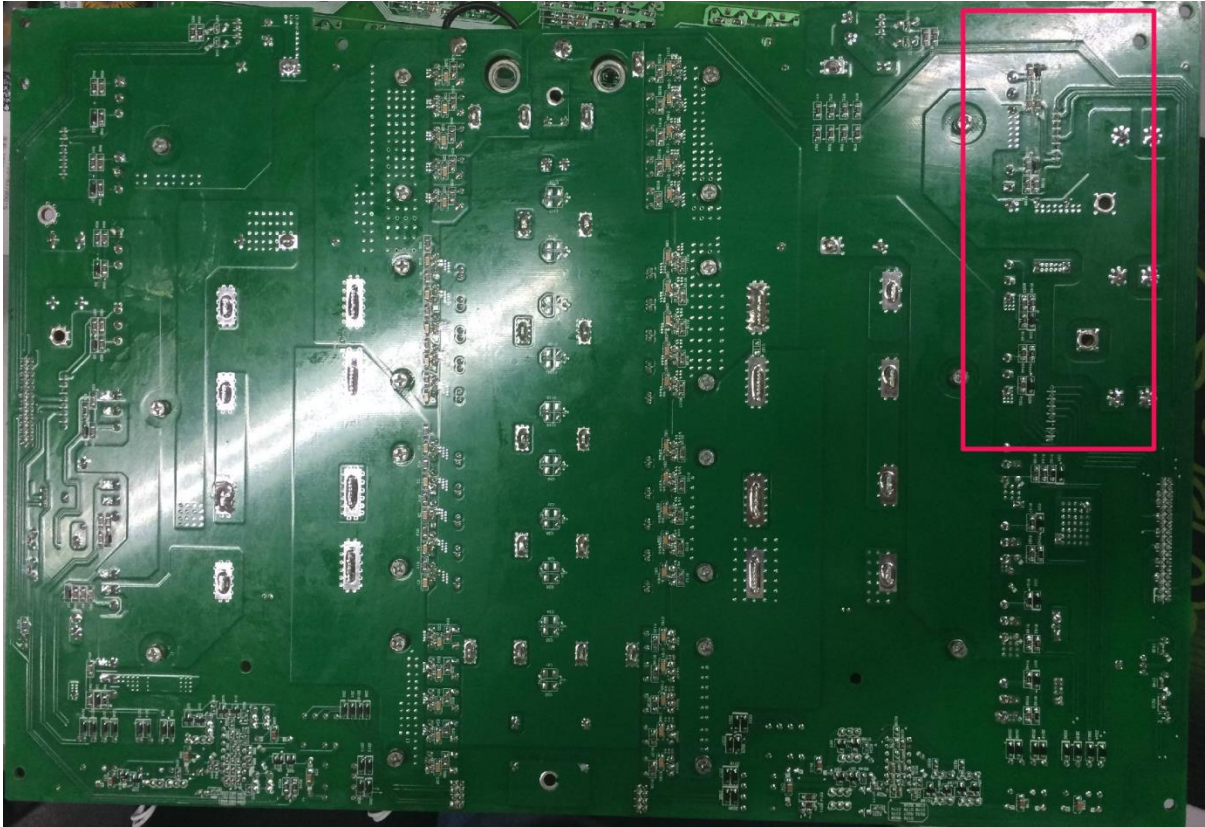

ALL of the IGBTs are 11-330087-00G (IGBT IR/IRGP4266DPBF 90A 650V N BULK TO-247)

Parts	Attribute	Reference values	Failure status
Q21/Q22/Q25/Q26 Q71/Q72/Q73/Q76	Resistor ¹	GE: 23.5k GC: 215k CE: OL	Short or explosion
	Diode	EC: 0.38V CE: OL	

3.2.3. SPS board checking

Step 1: Check the bus soft start circuit:

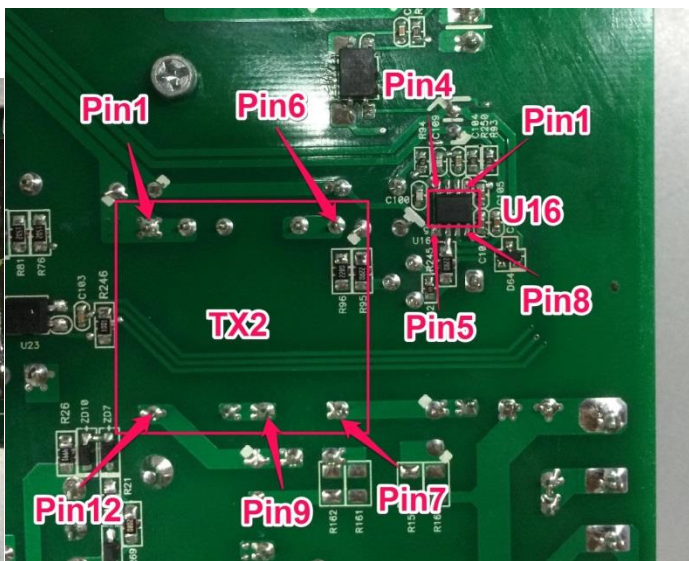
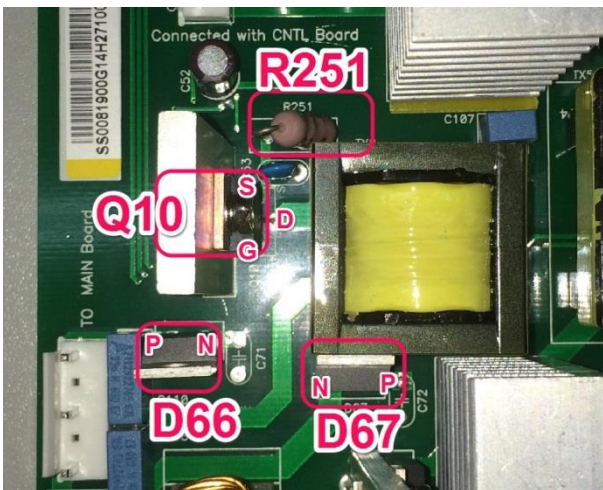
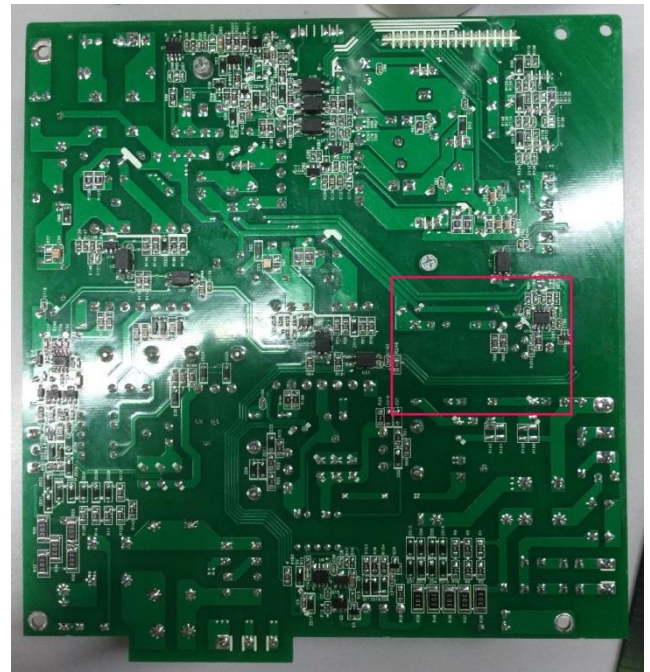
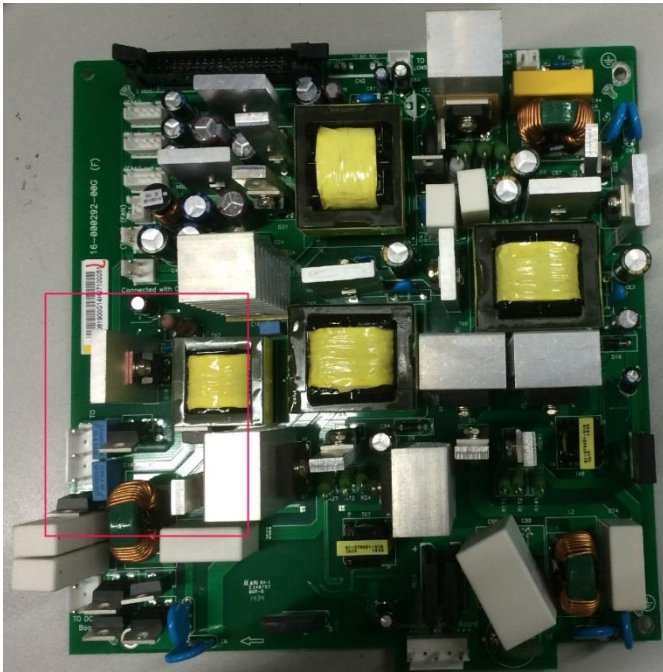

D66/D67: 11-200023-00G (D FC/RHRP8120 8A 1200V UFST RAD BULK)

Q10: 11-320020-00G (MOSFET IR/IRF630N 9.3A 200V N BULK TO-220)

R251: 14-600008-00G (RES 不燃性树脂型绕线 3W 0.1 J N-IND)

Note: If R251 is damaged, please replace U16 together.

U16: 11-1040160G (IC PWM CNTL ON/UC3845BD1R2G 8/SOIC-8)

Parts	Attribute	Reference values	Failure status
Q10	Resistor	GS: 1.17k GD: 130k	Short or explosion

Hybrid 10KW Service manual

		DS: OL	
	Diode	SD: 0.5V DS: OL	
R251	Resistor	0.1ohm	Open or other values
D66/D67	Resistor	+ to -: 230k - to +: OL	Short or explosion
	Diode	+ to -: 0.44V - to +: OL	
U16	Resistor	PIN7 TO PIN5: 1.5k PIN6 TO PIN5: 1.2k	Short or explosion

TX2 PIN7&PIN9 and PIN9&PIN12 need to be measured. The reference value is about 1.5ohm. If it is not, please replace the TX2 also.

TX2: 41-070250-00G (TX 120:13:120 FER ER28/28)

Step 2: Check the battery switching power supply circuit:

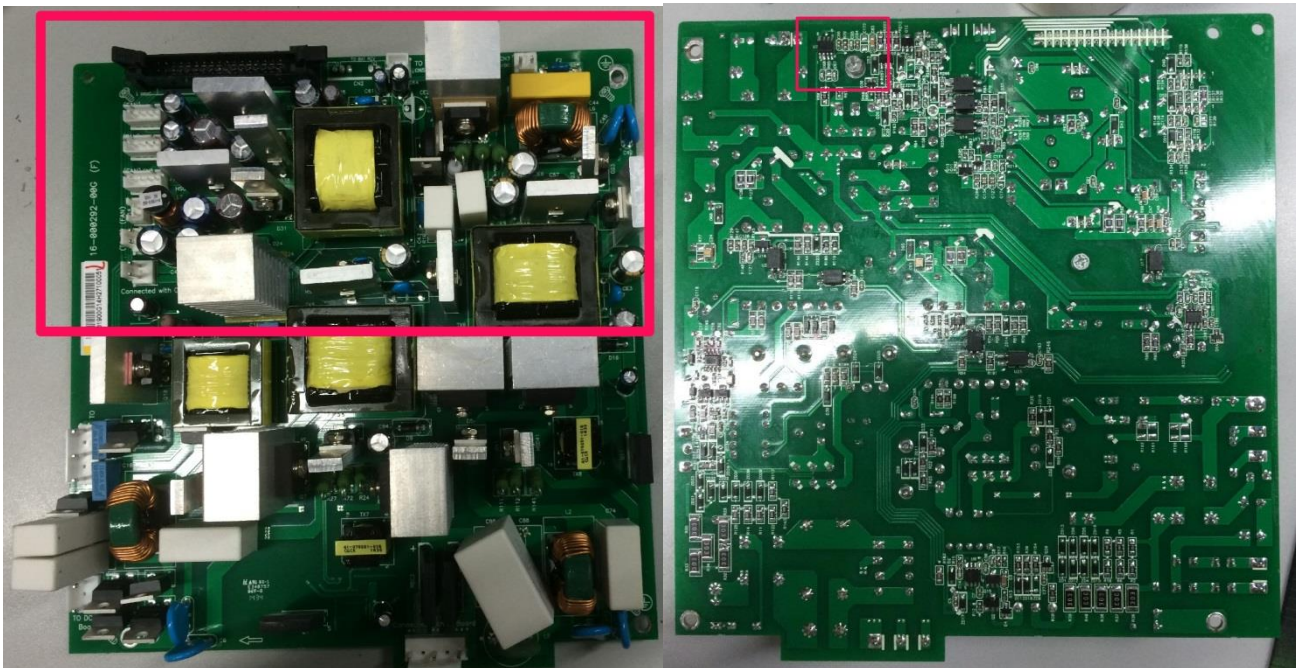

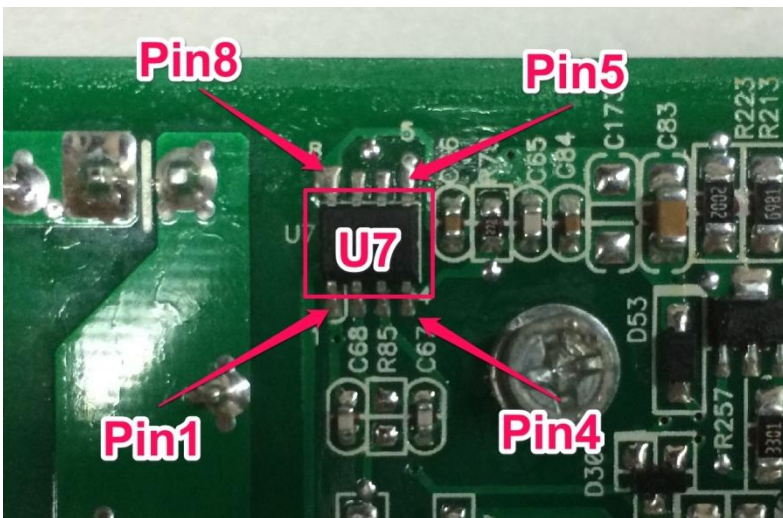
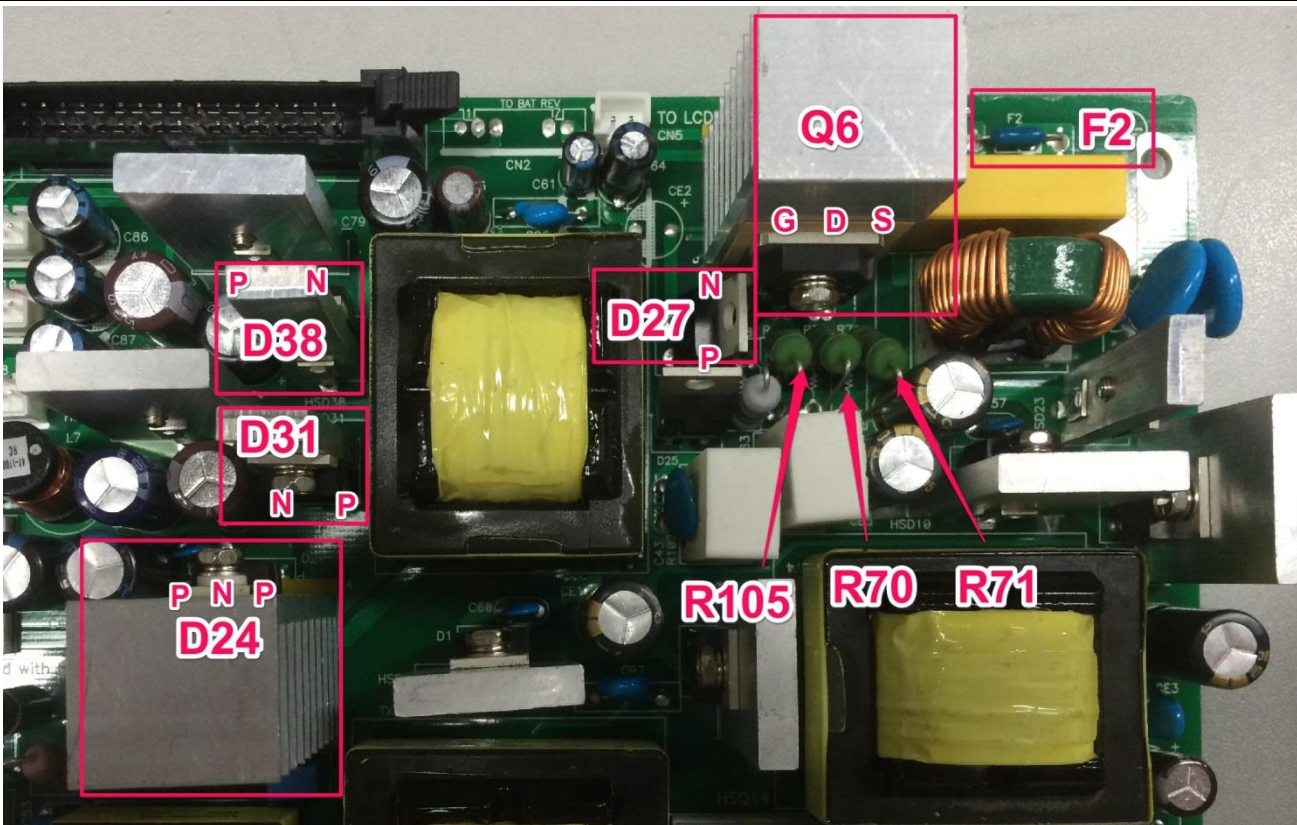

D31/D38: 11-200077-00G (D PANJIT/SB10100 10A 100V SCKY RAD TO-220AC TAP)

D24: 11-200056-00G (D ST/STPS30L60CT 30A 60V SCKY RAD TO-220 BULK)

D27: 11-200015-00G (D PANJIT/SB10150 10A 150V SCKY RAD BULK)

Q6: 11-320081-00G (MOSFET FAIRCHILD/FDA59N30 35A 300V N BULK TO-247)

R70/R71/R105: 14-600017-00G (RES 不燃性树脂型绕线 3W 0.15 J N-IND)

F2: 25-000061-00G (FUSE HOLLY LAND/20N-100L 10A 125V FAST7.3*2.7)

Note: If R70/R71/R105 is damaged, please replace U7 together.

U7: 11-104016-00G (IC PWM CNTL ON/UC3845BD1R2G 8/SOIC-8)

Hybrid 10KW Service manual

Parts	Attribute	Reference values	Failure status
D31/D38	Resistor	+ to -: 276k - to +: OL	Short or explosion
	Diode	+ to -: 0.27V - to +: OL	
Q6	Resistor	GS: 16k GD: 200k DS: 2.4M	Short or explosion
	Diode	SD: 0.5V DS: OL	
R70/R71/R105	Resistor	0.15 ohm	Open or other values
D24	Resistor	+ to -: 91ohm - to +: 350k	Short or explosion
	Diode	+ to -: 0.09V - to +: 2.0V	
D27	Resistor	+ to -: 272ohm - to +: 1.5k	Short or explosion
	Diode	+ to -: 0.27V - to +: 1.1V	
U7	Resistor	PIN7 TO PIN5: 2k PIN6 TO PIN5: 16k	Short or explosion
F2	Resistor	0 ohm	Open or other values

Step 3: Check the AC switching power supply circuit:

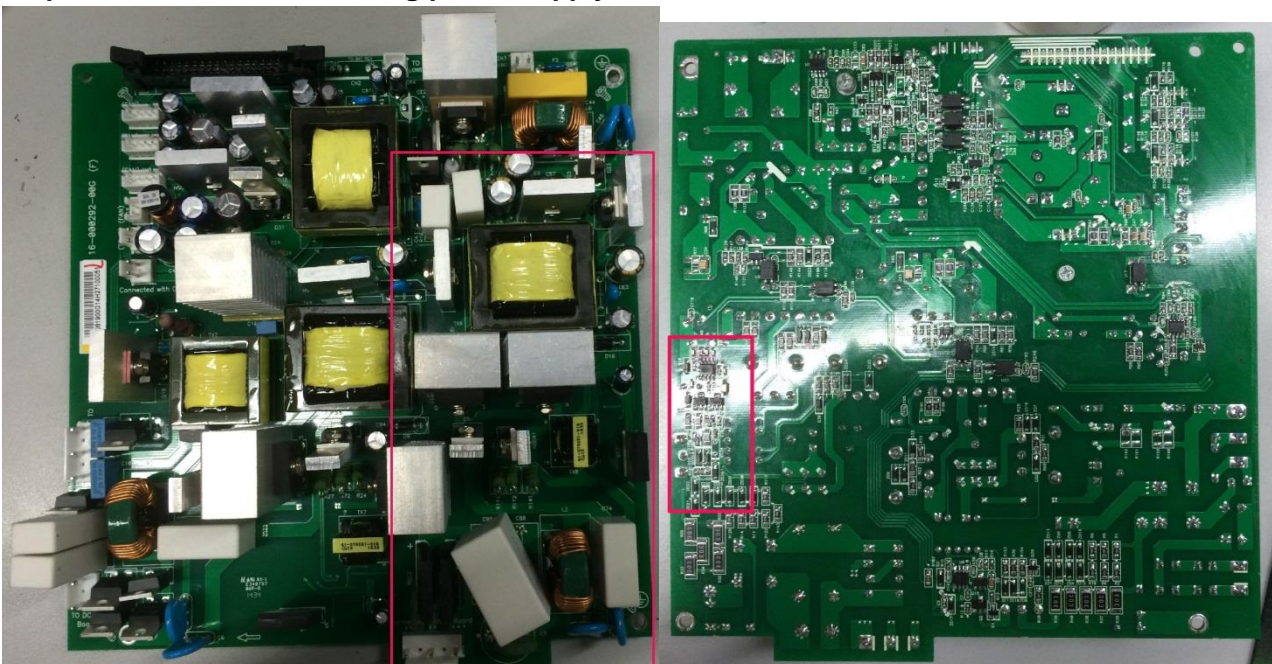

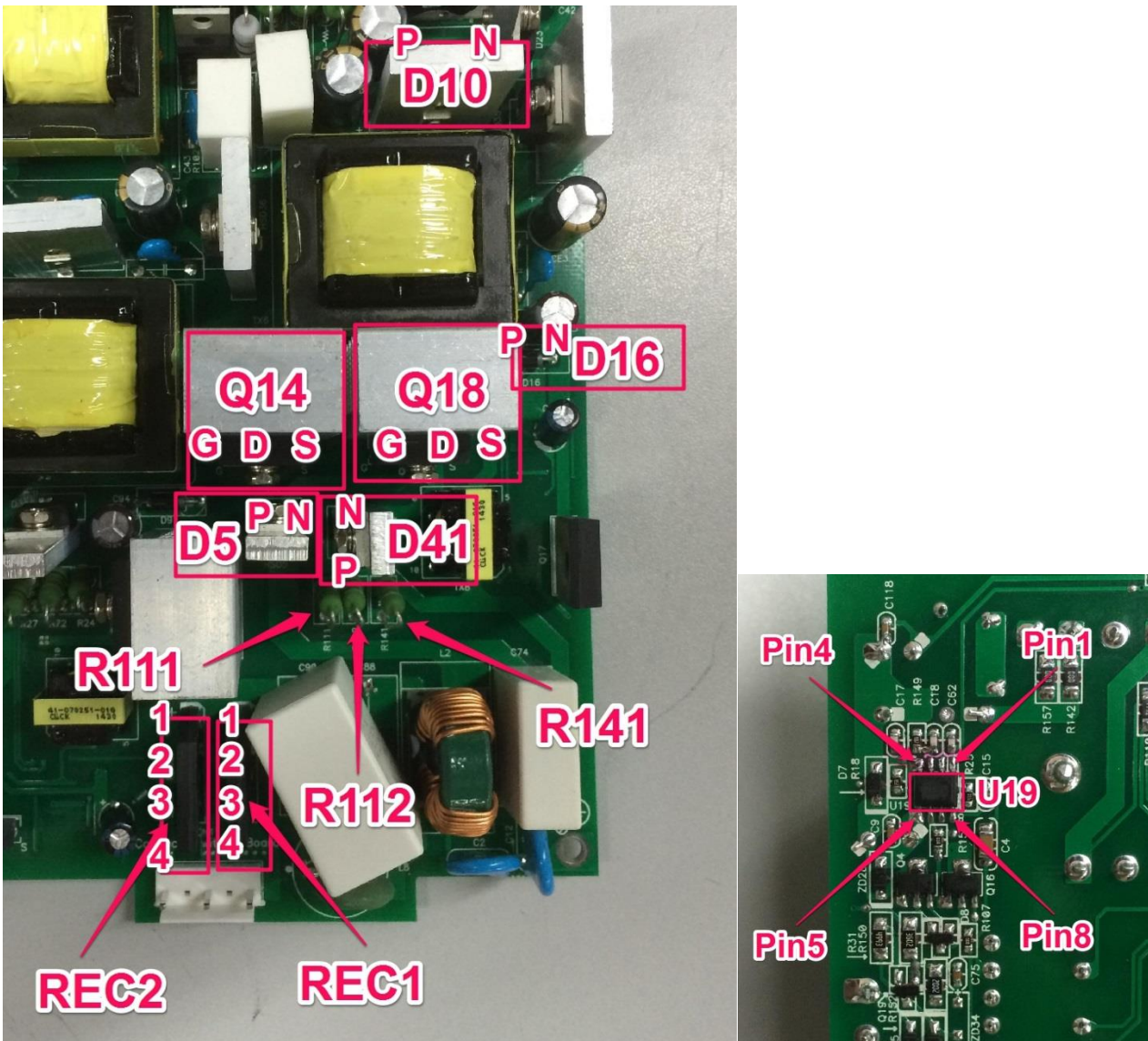

D10: X11-200001-01G (ASSY D RHRP860 8A 600V SFST RAD BULK)

D16: 11-200011-00G (D PAJ/UF204 2A 400V UFST TAP)

D5/D41: 11-200023-00G (D FC/RHRP8120 8A 1200V UFST RAD BULK)

Q14/Q18: 11-320091-00G (MOSFET ST/STW6N120K3 6A 1200V N BULK TO-247)

R111/R112/R141: 14-600010-00G (RES 不燃性树脂型绕线 2W 1 J N-IND)

REC1/REC2: 11-200068-00G (D PAJ/GBU4M 4A 1000V UFST RAD BULK)

Note: If R111/R112/R141 is damaged, please replace U19 together.

U19: 11-104002-00G (IC PWM CNTL TI/UC2844D8 SMD)

Parts	Attribute	Reference values	Failure status
D10	Resistor	+ to -: 100k - to +: OL	Short or explosion
	Diode	+ to -: 0.4V - to +: OL	
D16	Resistor	+ to -: 453k - to +: OL	Short or explosion

Hybrid 10KW Service manual

	Diode	+ to -: 0.46V - to +: OL	
D5/D41	Resistor	+ to -: 227k - to +: OL	Short or explosion
	Diode	+ to -: 0.44 - to +: OL	
Q14/Q18	Resistor	GS: 21ohm GD: 227.3k DS: OL	Short or explosion
	Diode	SD: 0.44V DS: OL	
R111/R112/R141	Resistor	1.0 ohm	Open or other values
U19	Resistor	PIN7 TO PIN5: 170k PIN6 TO PIN5: 600k	Short or explosion

Step 4: Check the PV switching power supply circuit:

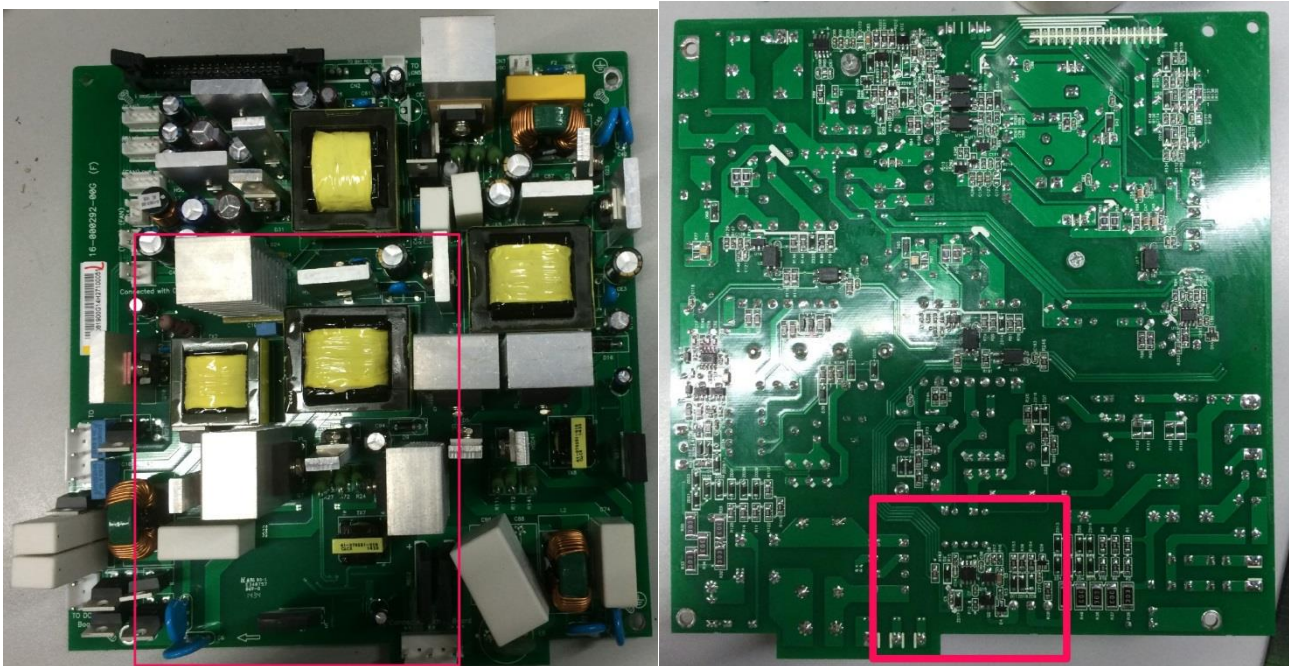

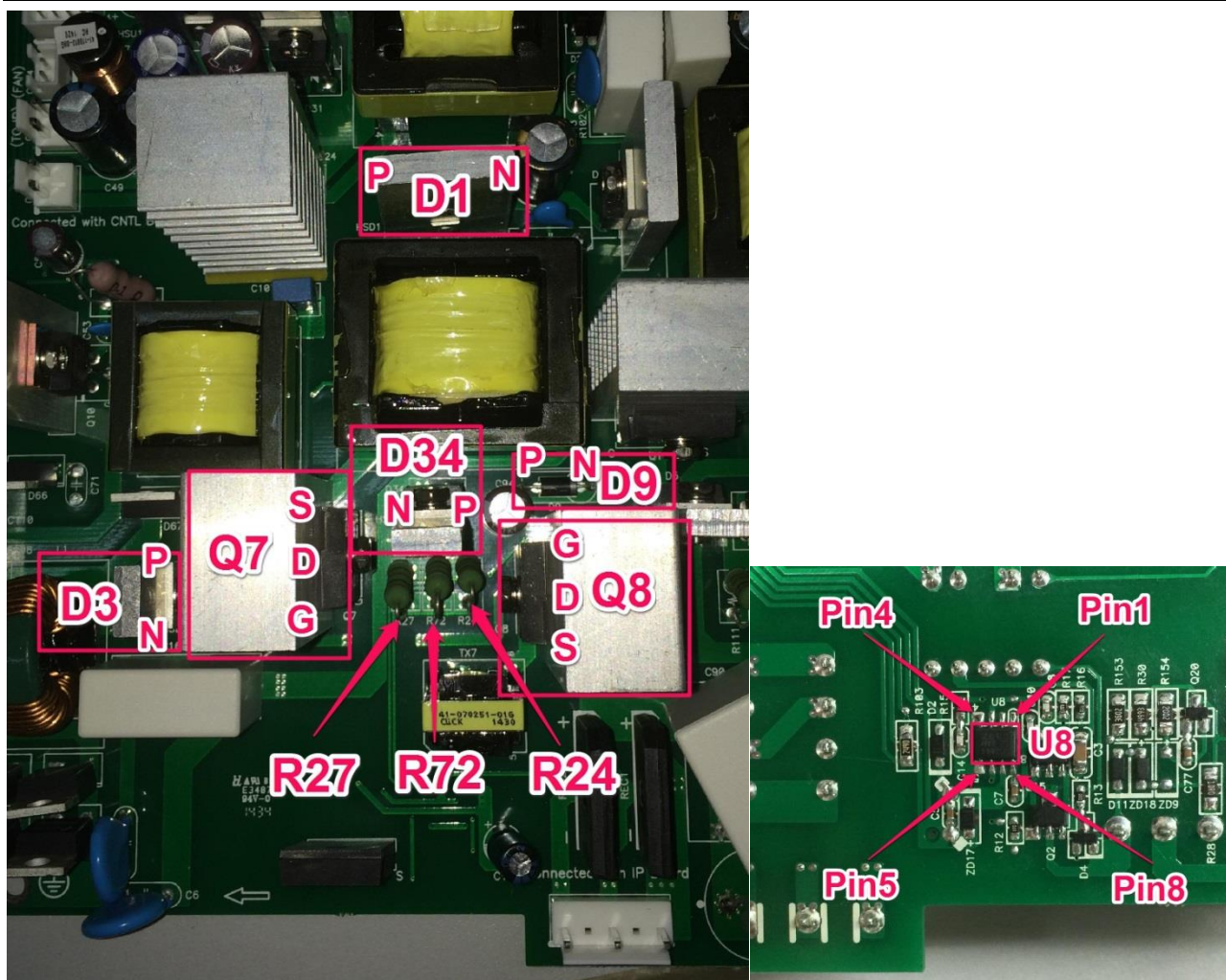

- D1: X11-200001-01G (ASSY D RHRP860 8A 600V SFST RAD BULK)
- D9: 11-200011-00G (D PAJ/UF204 2A 400V UFST TAP)
- D3/D34: 11-200023-00G (D FC/RHRP8120 8A 1200V UFST RAD BULK)
- Q7/Q8: 11-320091-00G (MOSFET ST/STW6N120K3 6A 1200V N BULK TO-247)
- R24/R27/R72: 14-600010-00G (RES 不燃性树脂型绕线 2W 1 J N-IND)

Note: If R24/R27/R72 is damaged, please replace U8 together.

U8: 11-104002-00G (IC PWM CNTL TI/UC2844D8 SMD)

Parts	Attribute	Reference values	Failure status
D1	Resistor	+ to -: 100k - to +: OL	Short or explosion
	Diode	+ to -: 0.4V - to +: OL	
D9	Resistor	+ to -: 453k - to +: OL	Short or explosion
	Diode	+ to -: 0.46V - to +: OL	
D3/D34	Resistor	+ to -: 227k - to +: OL	Short or explosion

	Hybrid 10KW Service manual
--	-----------------------------------

	Diode	+ to -: 0.44V - to +: OL	
Q7/Q8	Resistor	GS: 21ohm GD: 227.3k DS: OL	Short or explosion
	Diode	SD: 0.44V DS: OL	
R24/R27/R72	Resistor	1.0ohm	Open or other values
U8	Resistor	PIN7 TO PIN5: 160k PIN6 TO PIN5: 600k	Short or explosion

After checking, please provide the information to the supplier or local service.

4. Appendix

4.1 PCBs replacement guideline

4.2.1. Open the top cover and bottom cover

Open the top cover by remove the screws as below:

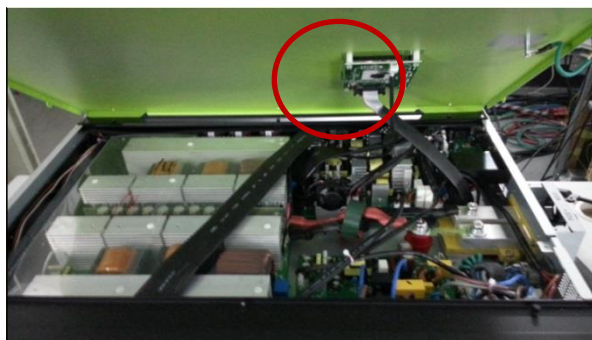
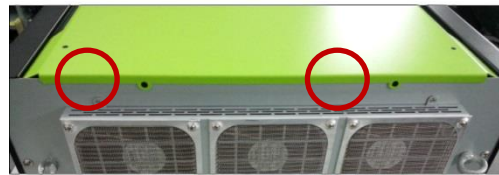
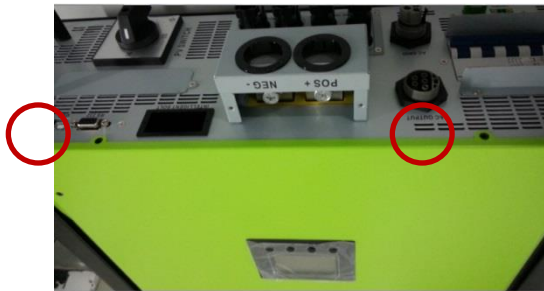
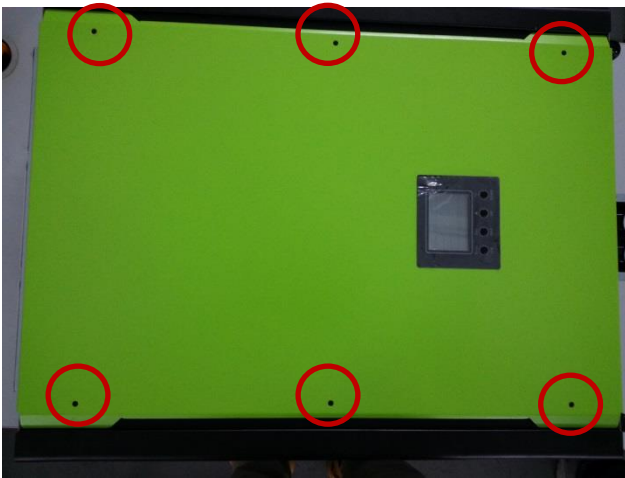

Open the bottom cover by remove the screws as below:

Hybrid 10KW Service manual

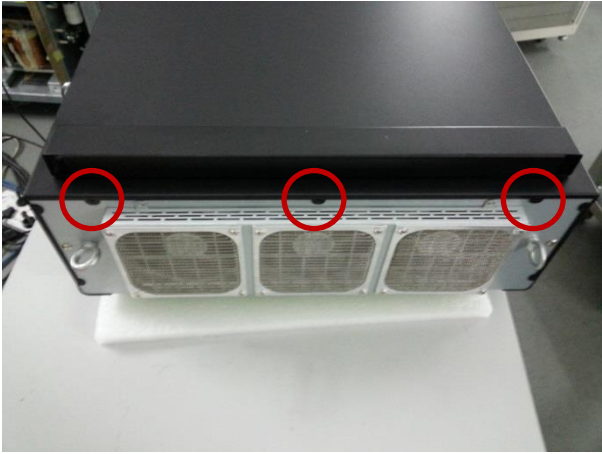

4.2.2. How to replace the main board

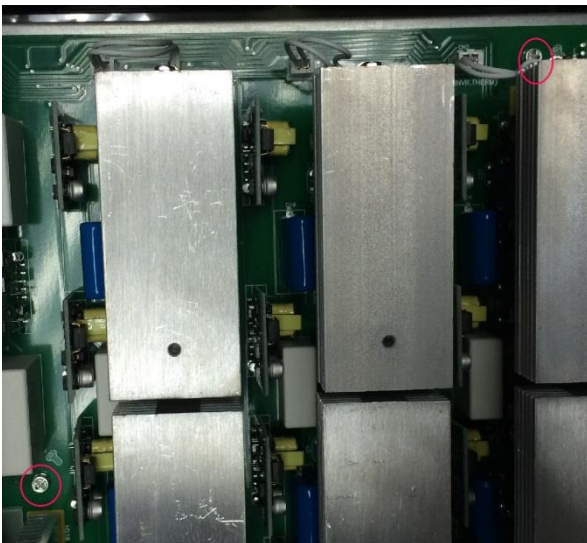
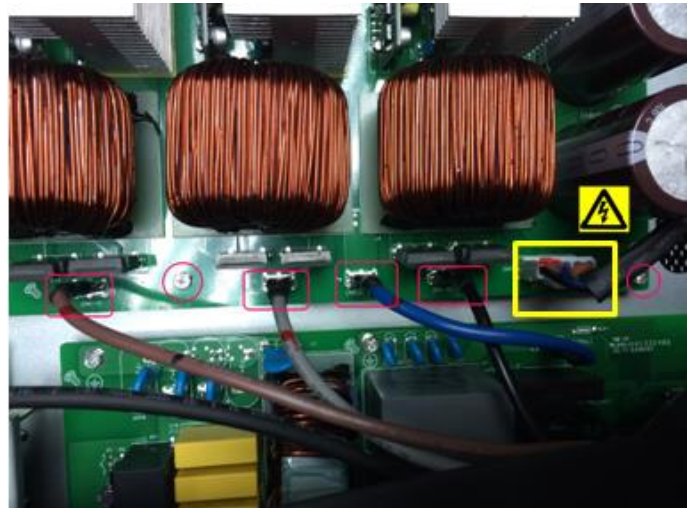
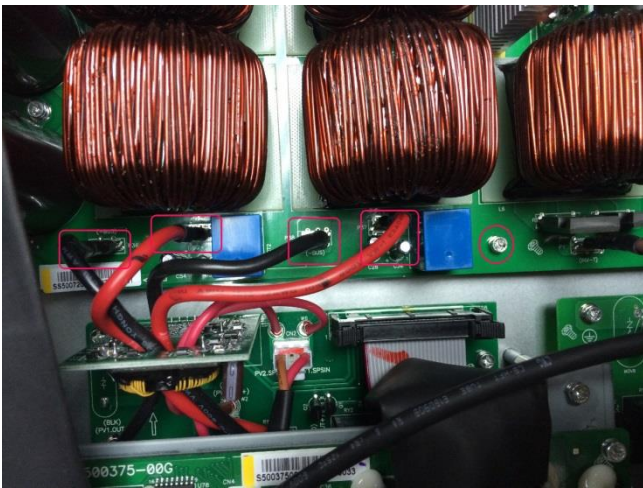
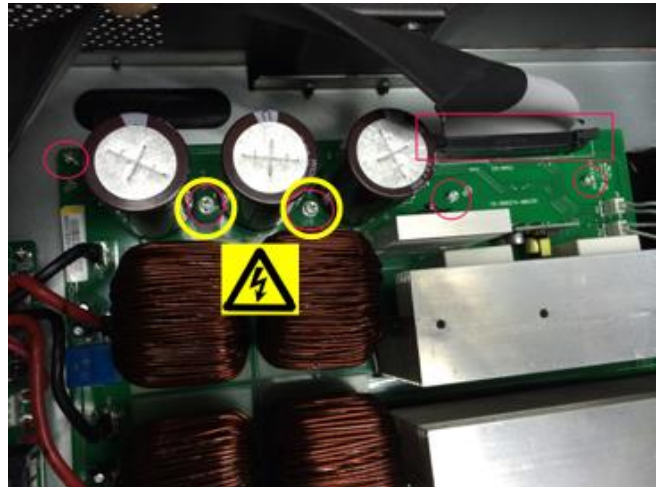

WARNING! The screws marked in **YELLOW** should be screwed tightly. Or when inverter works, it will cause the electrical hazard.

WARNING! The connector marked in **YELLOW** should be connected tightly. Or when inverter works, it will cause the electrical hazard.

4.2.3. How to replace the DC-DC board

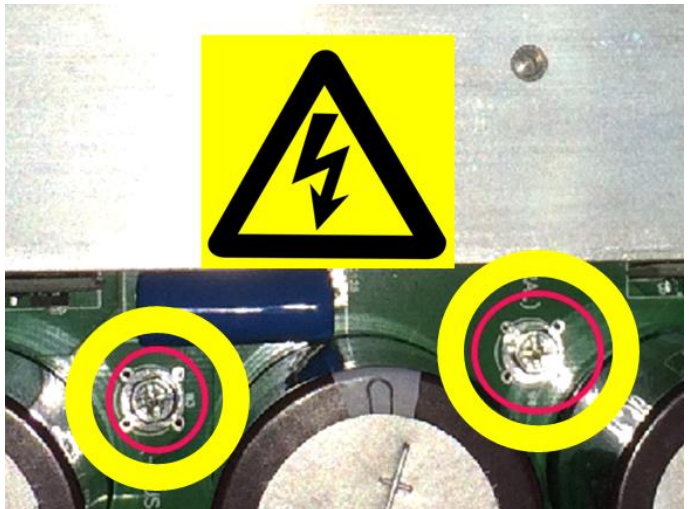
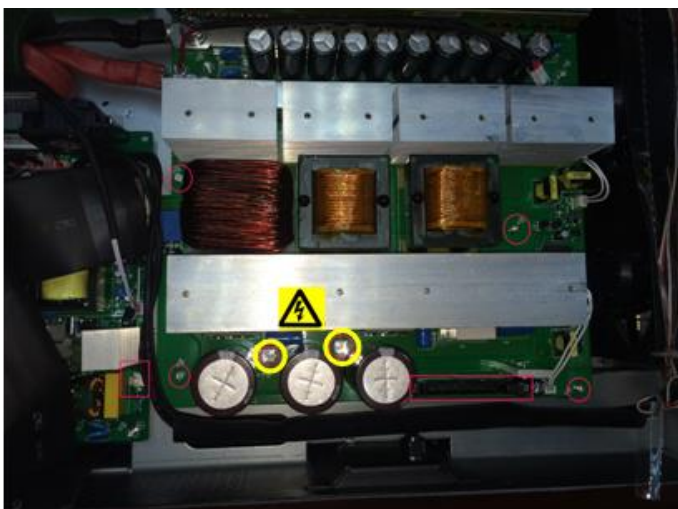
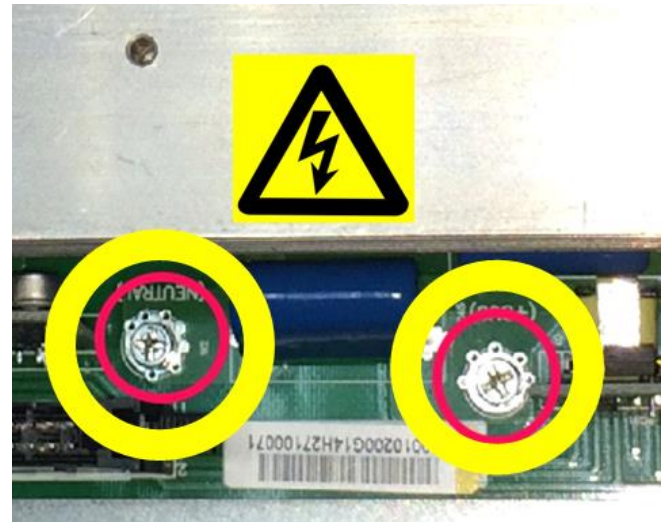
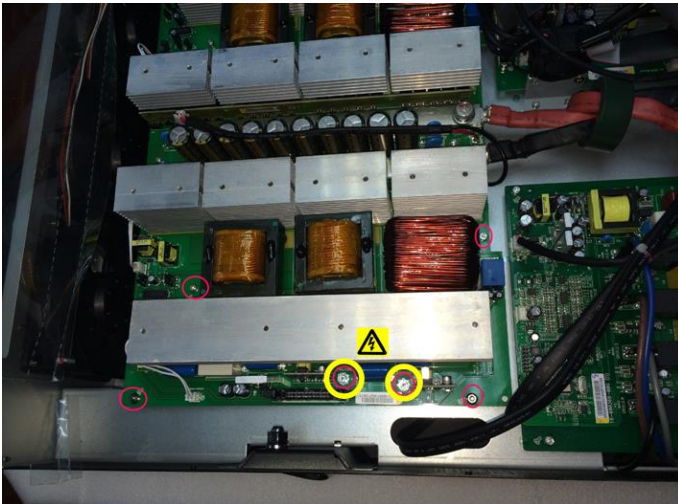
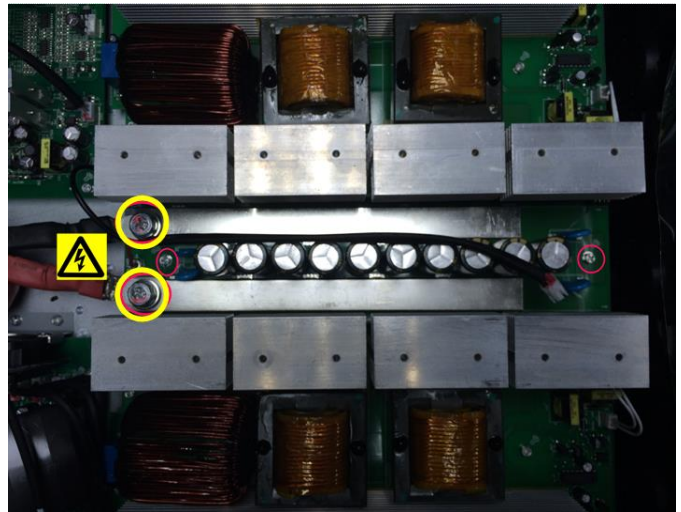
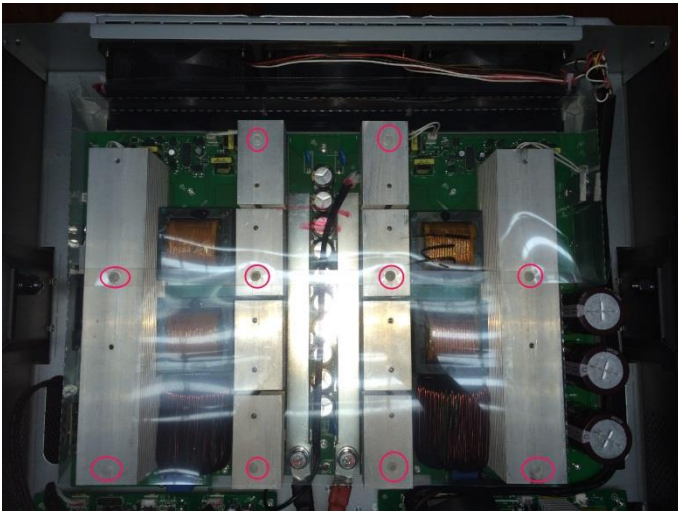

WARNING! The screws marked in **YELLOW** should be screwed tightly. Or when inverter works, it will cause the electrical hazard.

4.2.4. How to replace the SPS board

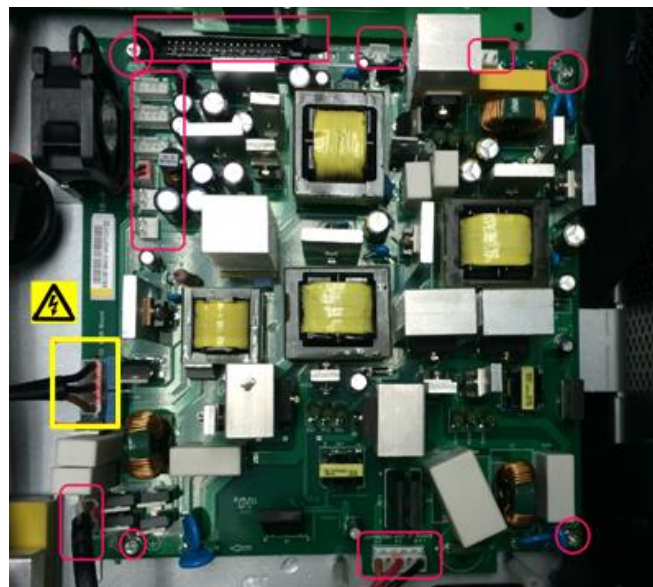
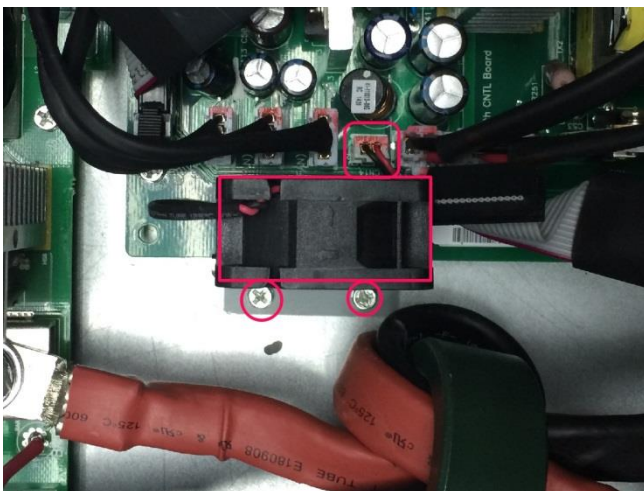
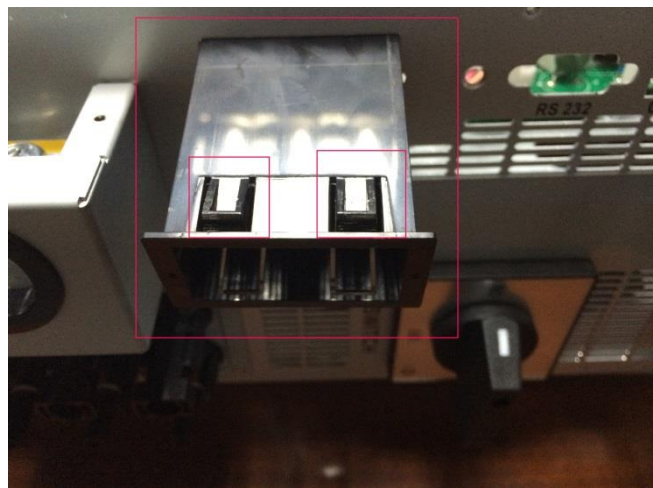
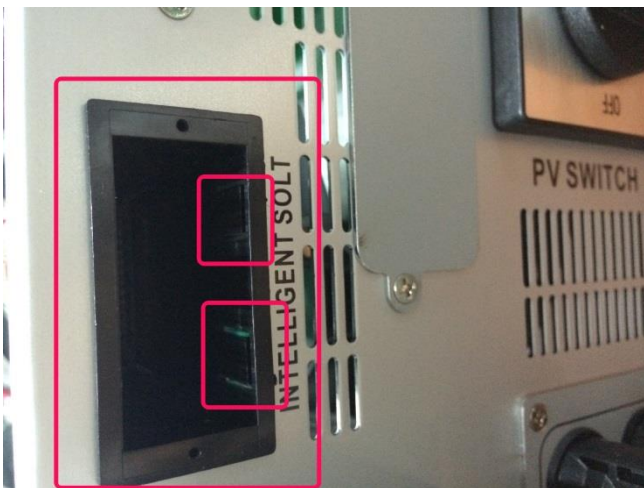
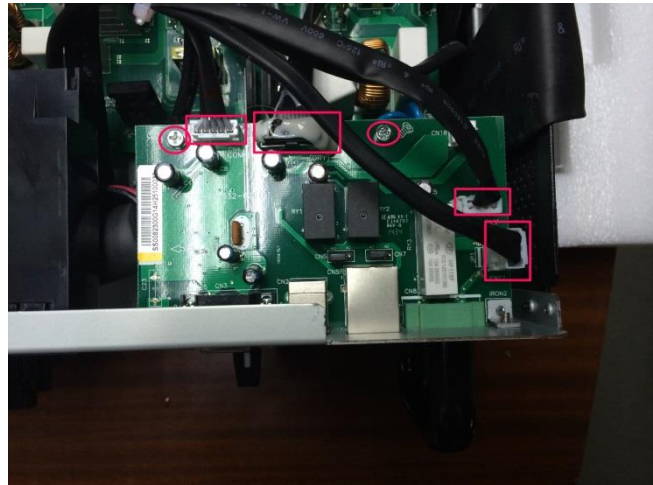
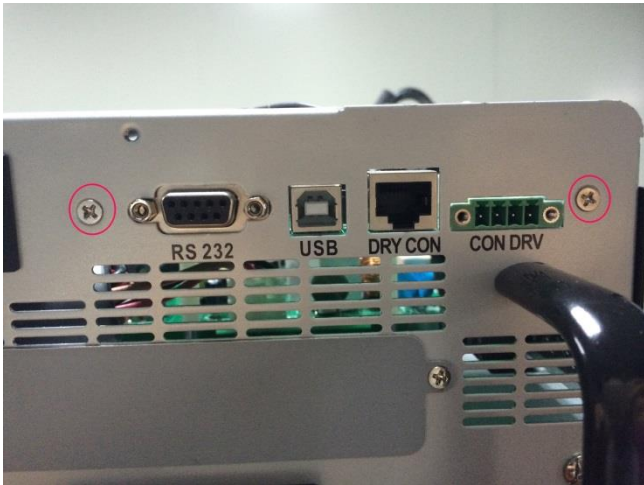

WARNING! The connector marked in YELLOW should be connected tightly. Or when inverter works, it will cause the electrical hazard.

4.2.5. How to replace the control board

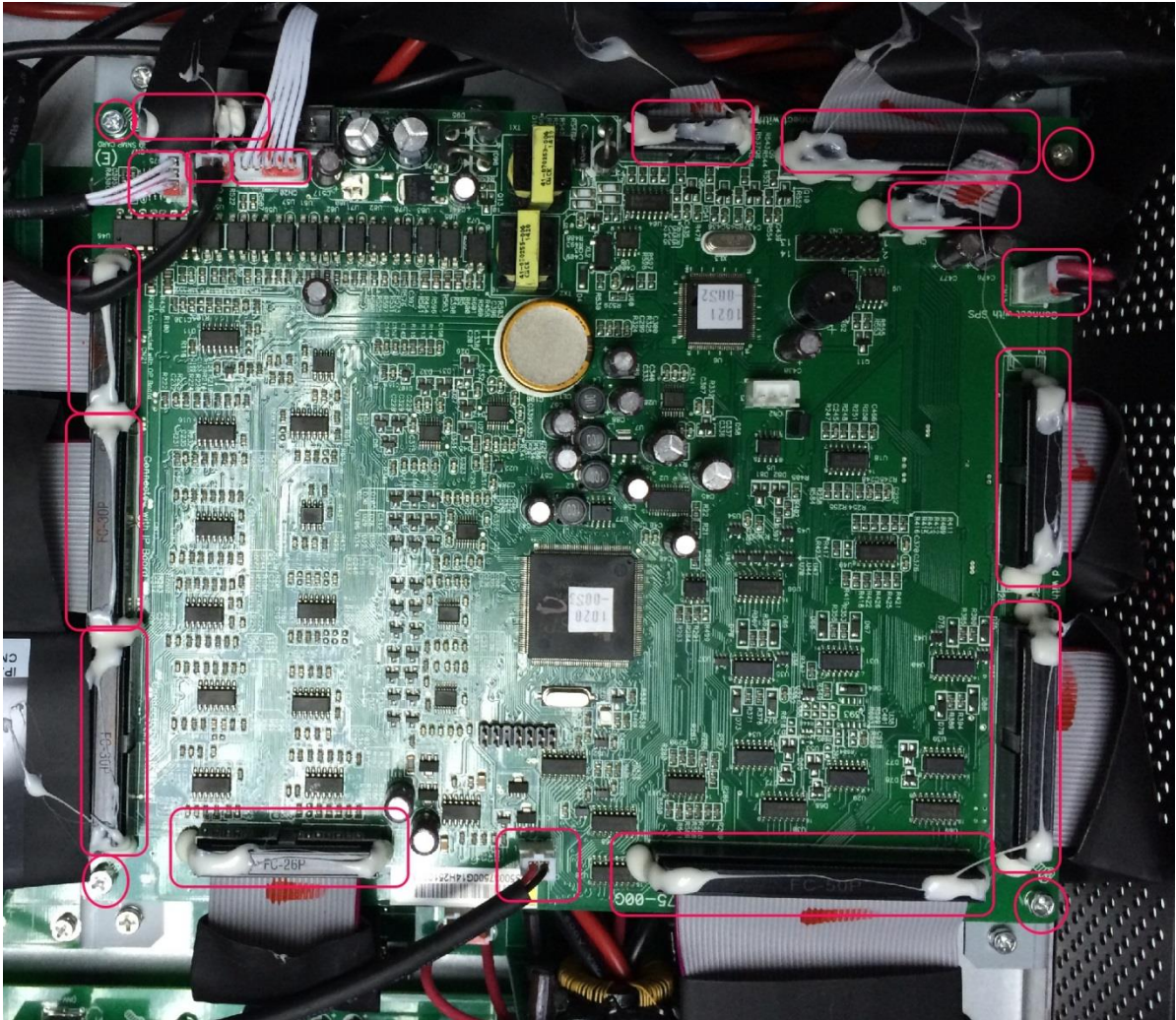

4.2.6. How to replace the PV EMI board

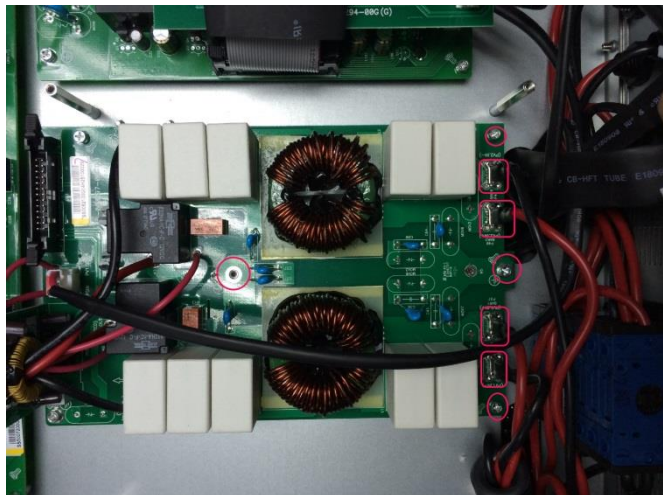
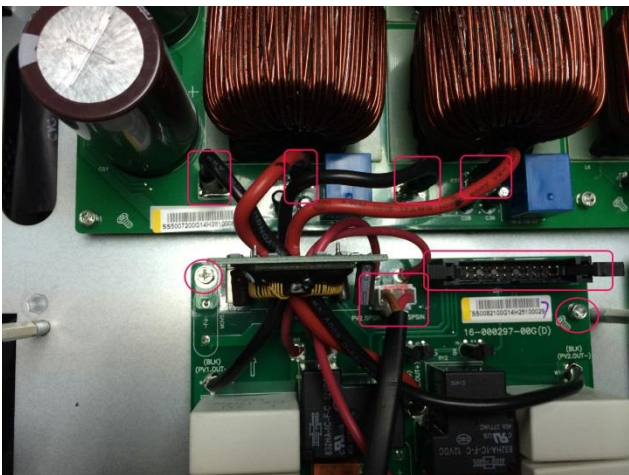
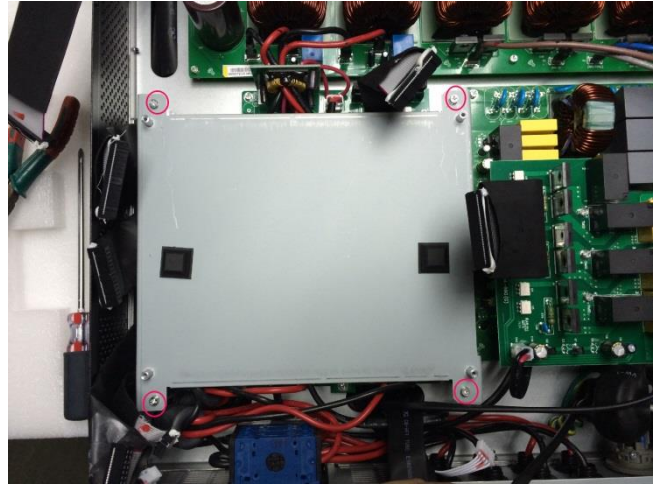
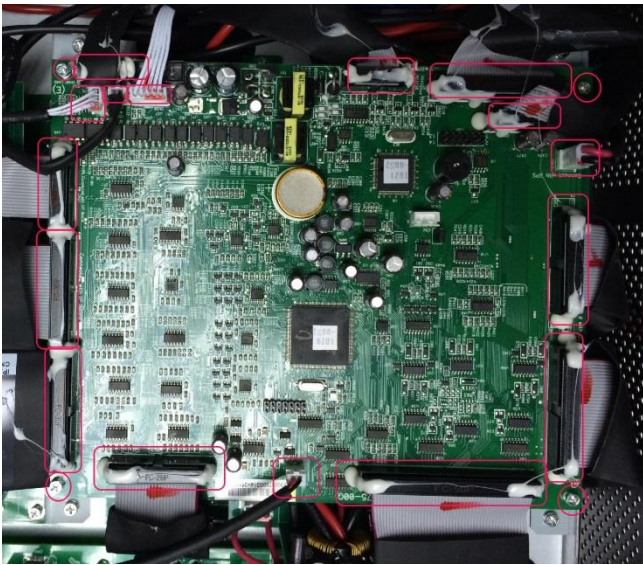

4.2.7. How to replace the relay board

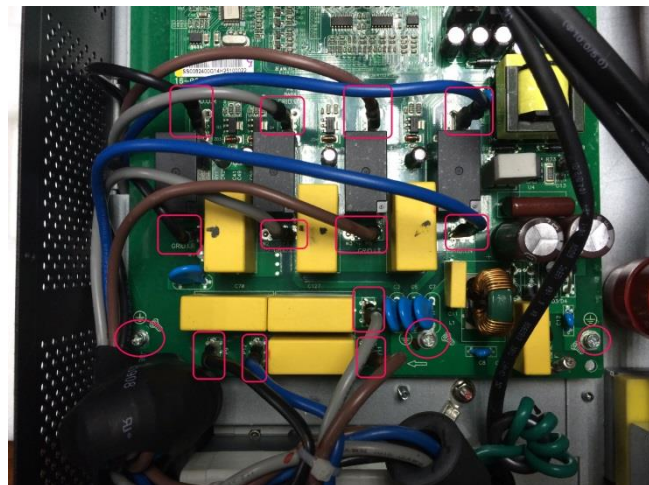
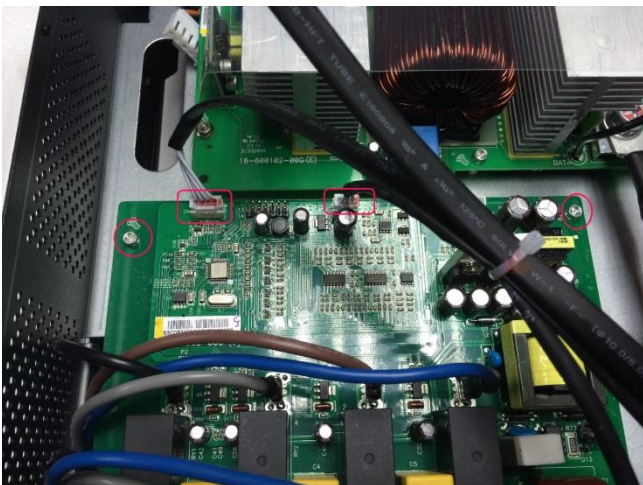

4.2.8. How to replace the OP board

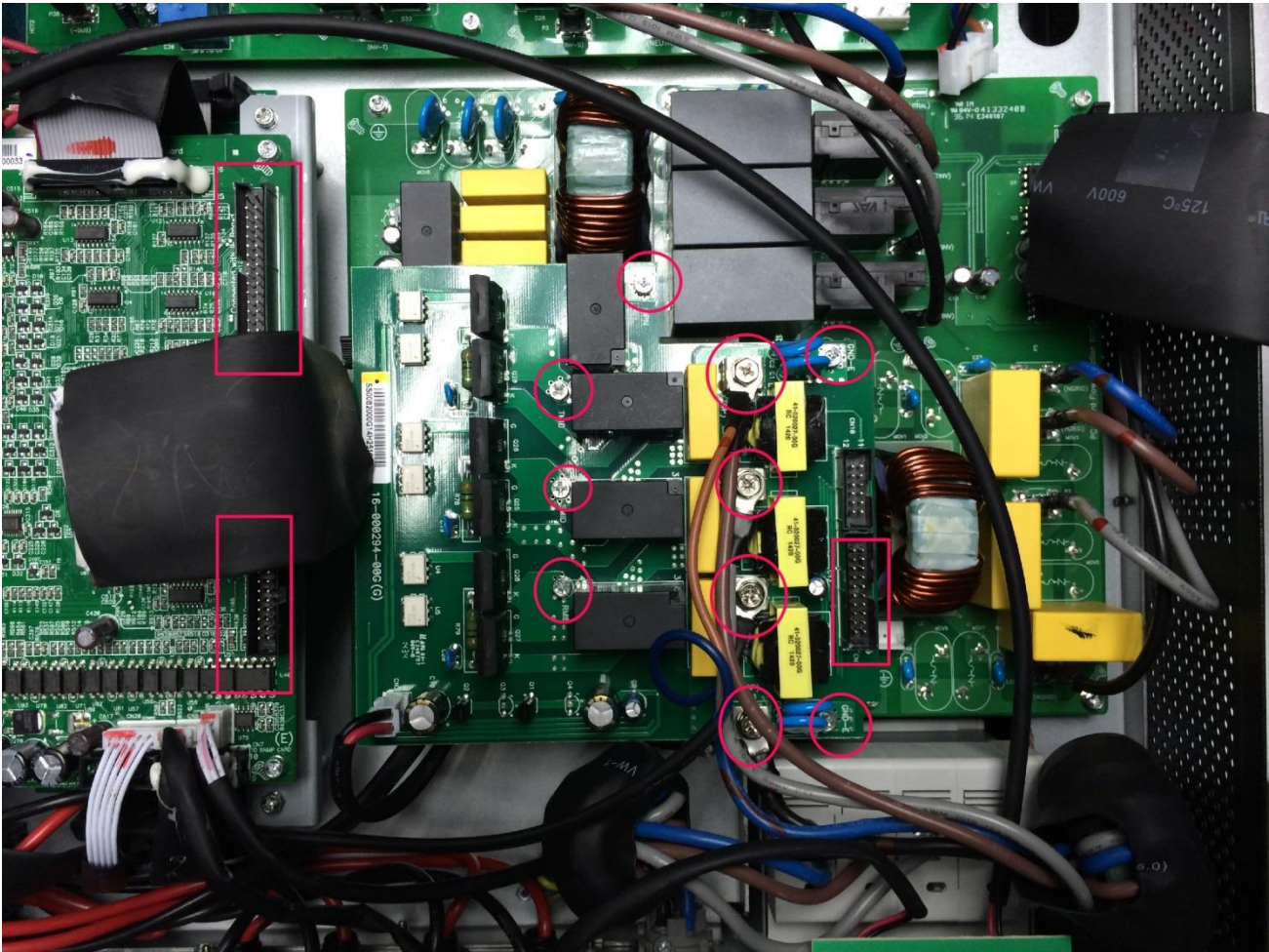

4.2.9. How to replace the IP board

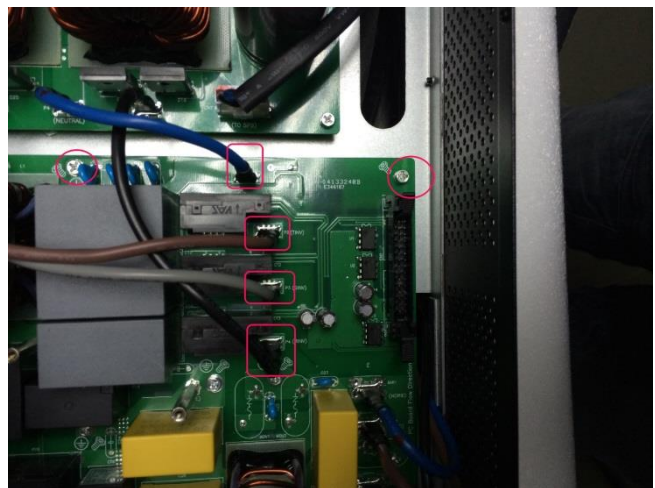
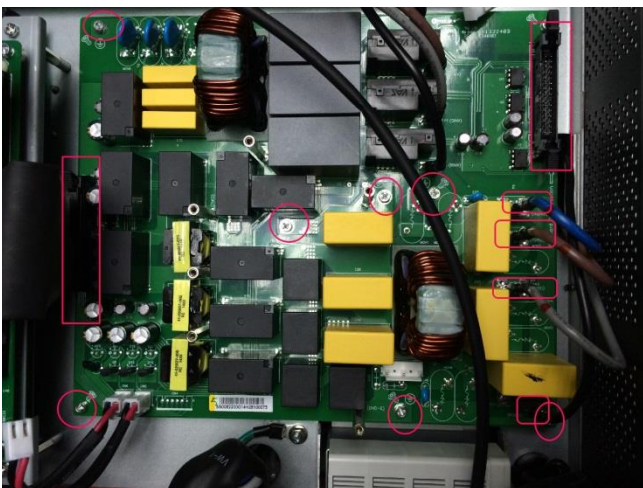

4.2.10. How to replace the fans

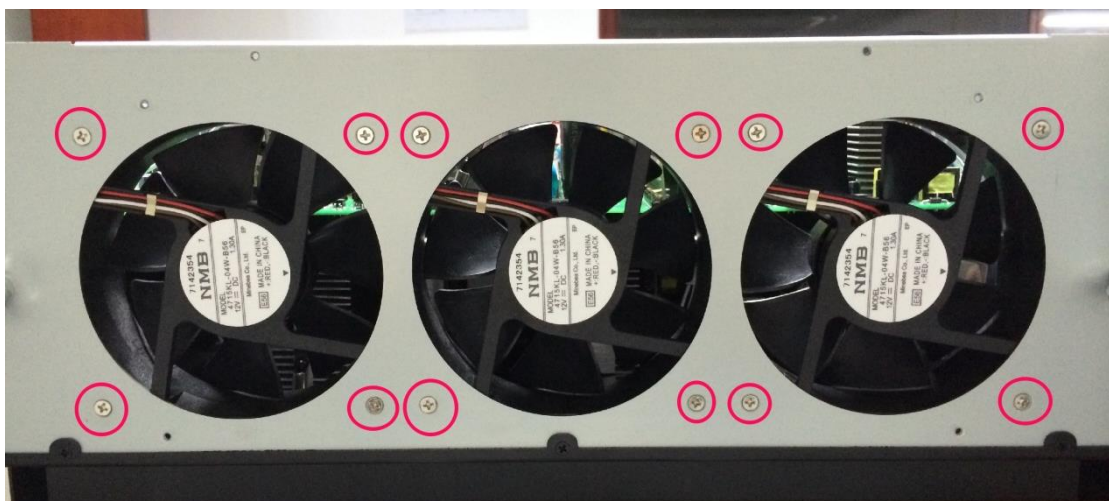
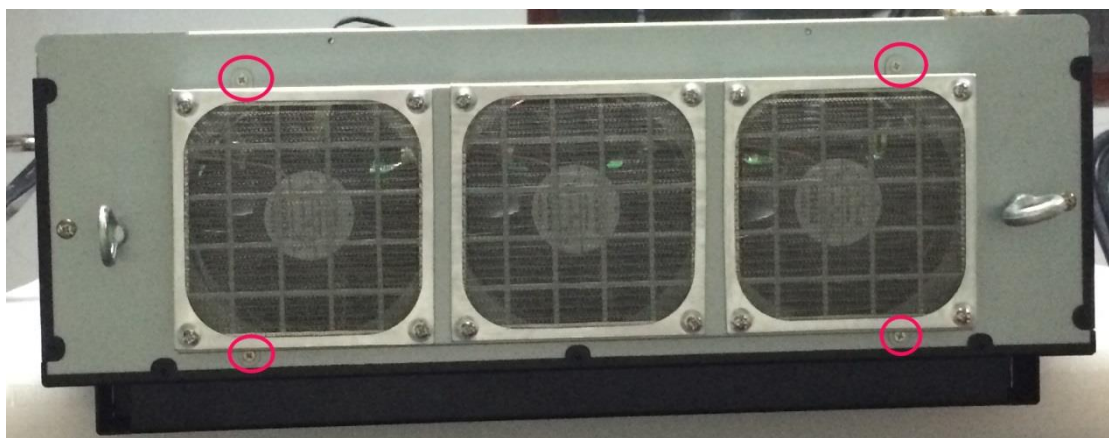
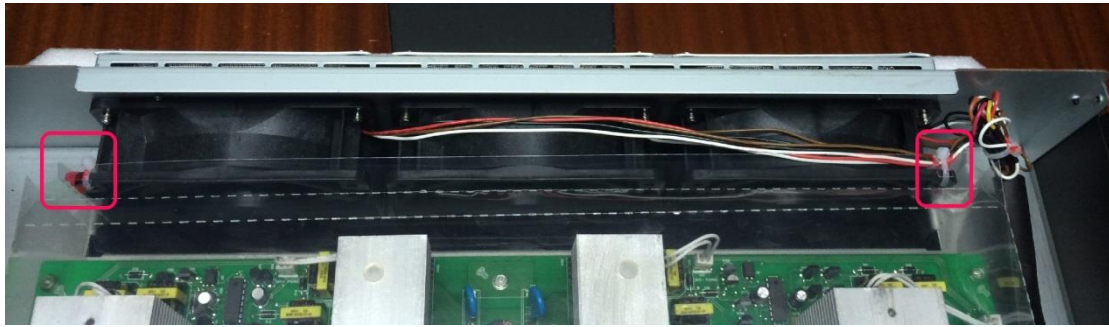

4.2 Signal cables connection guideline

Single unit:

Hybrid 10KW inverter signal cables diagram
(Single version)

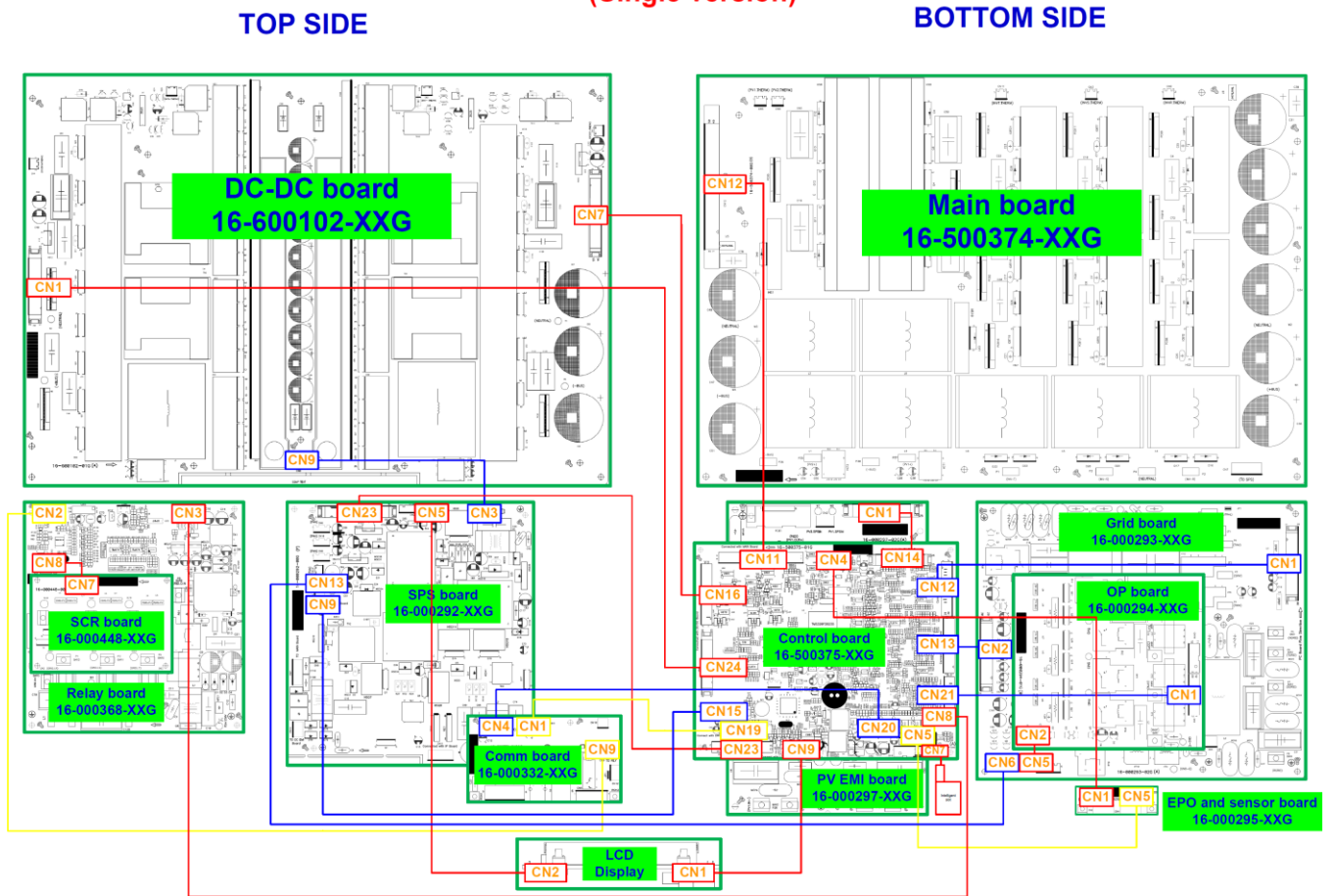

Hybrid 10KW Service manual

Parallel unit:

