



SDM230-Pulse

Single-Phase Two Module DIN rail Meters



- Measures kWh, Kvarh, KW, Kvar, KVA, PF, Hz, dmd, V, A, etc.
- Bi-directional measurement IMP & EXP
- Two pulse outputs
- Din rail mounting 35mm
- 100A direct connection
- Better than Class 1 / B accuracy

User Manual V1.0

2015

Application

The energy-meters “with a blue back-lighted LCD screen for perfect reading” are used to measure single-phase like residential, Utility and Industrial application. The unit measures and displays various important electrical parameters. Bi-directional energy measurement makes the unit a good choice for solar PV energy metering.

PART 1 Specification

General Specifications

Voltage AC (Un)	230V
Voltage Range	176~276V AC
Base Current (Ib)	10A
Max. Current (Imax)	100A
Mini Current (Imin)	0.5A
Starting current	0.4% of Ib
Power consumption	<2W/10VA
Frequency	50Hz(±10%)
AC voltage withstand	4KV for 1 minute
Impulse voltage withstand	6KV-1.2uS waveform
Overcurrent withstand	30Imax for 0.01s
Pulse output rate	1000imp/kWh (default) 1000/100/10/1 imp/kWh/kVarh (configurable)
Display	LCD with blue backlit
Max. Reading	999999.9kWh

Accuracy

Voltage	0.5% of range maximum
Current	0.5% of nominal
Frequency	0.2% of mid-frequency
Power factor	1% of Unity
Active power	1% of range maximum
Reactive power	1% of range maximum
Apparent power	1% of range maximum
Active energy	Class 1 IEC62053-21 Class B EN50470-3
Reactive energy	1% of range maximum

Environment

Operating temperature	-25°C to +55°C
Storage and transportation temperature	-40°C to +70°C
Reference temperature	23°C ± 2°C
Relative humidity	0 to 95%, non-condensing
Altitude	up to 2500m
Warm up time	10s
Installation category	CAT III
Mechanical Environment	M1
Electromagnetic environment	E2
Degree of pollution	2

Output

Pulse Output

The meter provides two pulse outputs. Both pulse outputs are passive type.

Pulse output 1 is configurable. The pulse output can be set to generate pulses to represent total / import/export kWh or kVarh.

The pulse constant can be set to generate 1 pulse per: 0.001(default) / 0.01/0.1/kWh/kVarh.

Pulse width: 200/100/60ms

Pulse output 2 is non-configurable. It is fixed up with import kWh. The constant is 1000imp/kWh.

Mechanics

Din rail dimensions	36x99x63 (WxHxD) DIN 43880
Mounting	DIN rail 35mm
Sealing	IP51 (indoor)
Material	self-extinguishing UL94V-0

LCD display

Item	Descriptions
1	7 digits used to display measured values or RTC
2	Total value
4	Import information, Export information
5	Max. Demand for Power or Current
6	Pulse output 1 and Pulse output 2
7	Measurement units
8	PF = power factor Hz = frequency
9	Bar display of Power
10	Communication indicator
11	Time information
12	Low battery warning
13	Lock symbol



PART 2 Operation

Initialization Display

When it is powered on, the meter will initialize and do self-checking.



Full screen → software version → total kWh







Scroll display by Button





After initialization and self-checking program, the meter display the measured values. The default page is total kWh. If the user wants to check other information, he needs to press the scroll button on the front panel.



The display order by scroll button

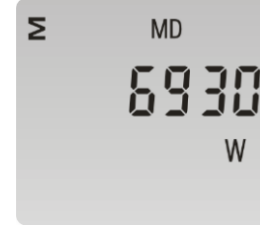

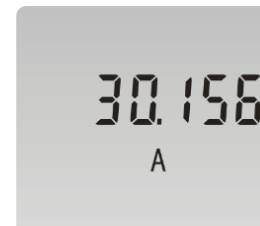
Total kWh → import kWh → export kWh → resettable kWh → total kVarh → import kVarh → export kVarh → resettable kVarh → Max. power demand → voltage → current → W → Var → VA → power factor → frequency → pulse constant.

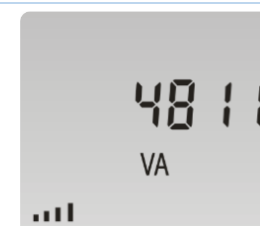
Page	Display	Descriptions
1		Total active energy Example:70.00kWh
2		Import active energy Example: 50.00kWh
3		Export active energy Example: 20.00kWh
4		Total resettable energy
5		Total reactive energy Example: 10.00kVarh
6		Import reactive energy Example: 5.00kVarh
7		Export reactive energy Example: 5.00kVarh

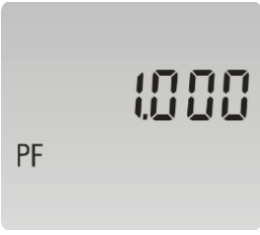

8		Total resettable reactive energy
9		Total max. demand Example: 6930W
10		Voltage Example: 229.8V
11		Current Example: 30.156A
12		Active Power Example: 4700W
13		Reactive Power Example: 1030Var
14		Apparent power Example: 4811VA



15		Power factor Example: 1.000
16		Frequency Example: 49.99Hz
17		Pulse Constant Example: 1000



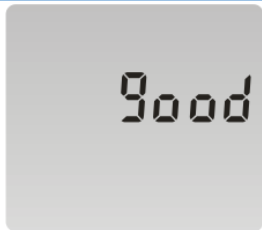

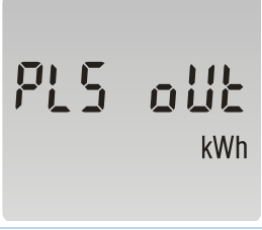
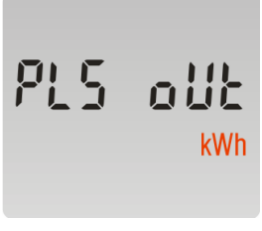
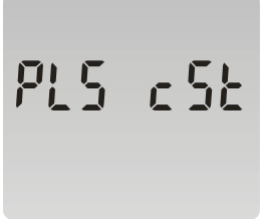
Set-up Mode

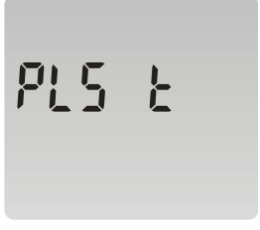

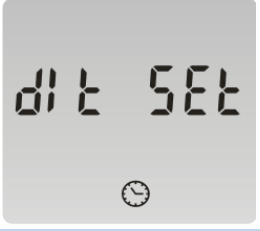
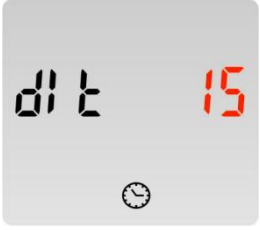
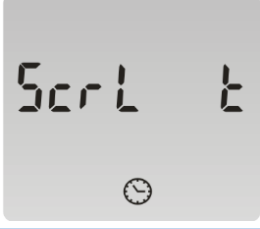
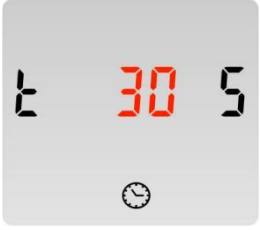
To get into Set-up Mode, the user need press the “Enter” button  for 3 second.

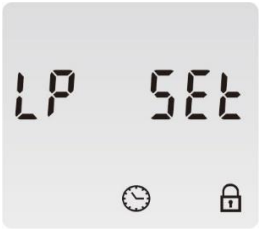
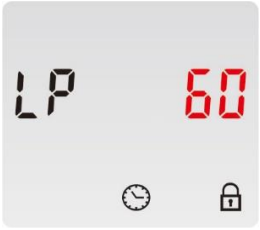
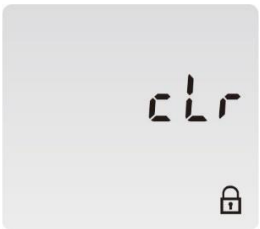
Page	Display	Descriptions
		The setting is done correctly
		The entering information is wrong. The operation fails.
1		Password To get into Set-up mode, it asks a password confirmation. Default password: 1000
2		Pulse Output Default: Export kWh Option: kWh / KVarh / Imp. kWh / Exp.kWh / Imp.kVarh / Exp.kVarh
2-1		Press the “Enter” button, the red part flash. Press the “Scroll” button to change the option. After choose the new Pulse output option, the user need pressing the “Enter” button to confirm the setting.
3		Pulse Constant Default: 1000 Option: 1000 / 100 / 10 / 1

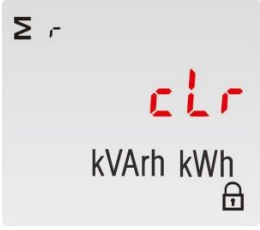
3-1		<p>Press the “Enter” button, the red part flash. Press the “Scroll” button to change the option. After choose the new Pulse constant option, the user need pressing the “Enter” button to confirm the setting.</p>
4		<p>Pulse duration Default: 100mS Option: 200 / 100 / 60ms</p>
4-1		<p>Press the “Enter” button, the red part flash. Press the “Scroll” button to change the option. After choose the new Pulse duration option, the user need pressing the “Enter” button to confirm the setting.</p>
5		<p>Demand Integration Time Default: 15 minutes Option: 0 / 5 / 10 / 15 / 30 / 60</p>
5-1		<p>Press the “Enter” button, the red part flash. Press the “Scroll” button to change the option. After choose the new DIT option, the user need pressing the “Enter” button to confirm the setting.</p>
6		<p>Automatic Scroll Time Interval Default: 0 S Option: 0 ~ 30S</p>
6-1		<p>Press the “Enter” button, the red part flash. Press the “Scroll” button to change the option. After choose the new “Scrl” option, the user need pressing the “Enter” button to confirm the setting.</p>

7		<p>Backlit lasting time set-up Default: 60 min Option: 0 (OFF) / 5/ 10/ 20/ 30/ 60 Long press "Enter" button to enter set-up mode.</p>
7-1		<p>Press the "Scroll" button to change the option. After choose the new "Scrl" option, the user need pressing the "Enter" button to confirm the setting.</p>
8		<p>Clear Long press "Enter" to enter clear interface.</p>
8-1		<p>Clear Max demand of active power Long press "Enter" button to confirm the operation.</p>
8-2		<p>Clear the resettable energy Long press the Enter button to confirm the operation.</p>
9		<p>Password Default: 1000</p>
9-1		<p>Press the "Enter" button, the red part flash. Press the "Scroll" button to change the value. After choose the new password, the user need pressing the "Enter" button to confirm the setting.</p>

Wiring diagram

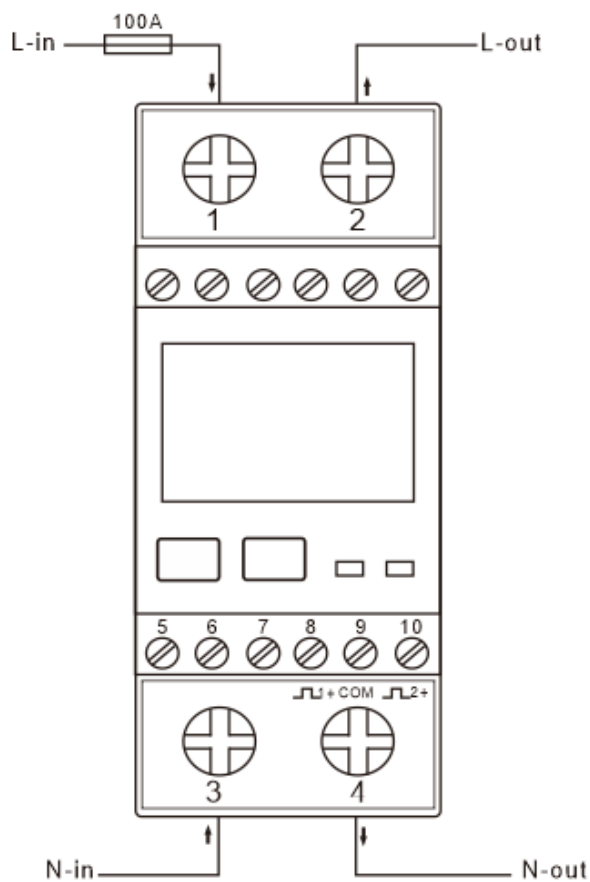

Dimensions

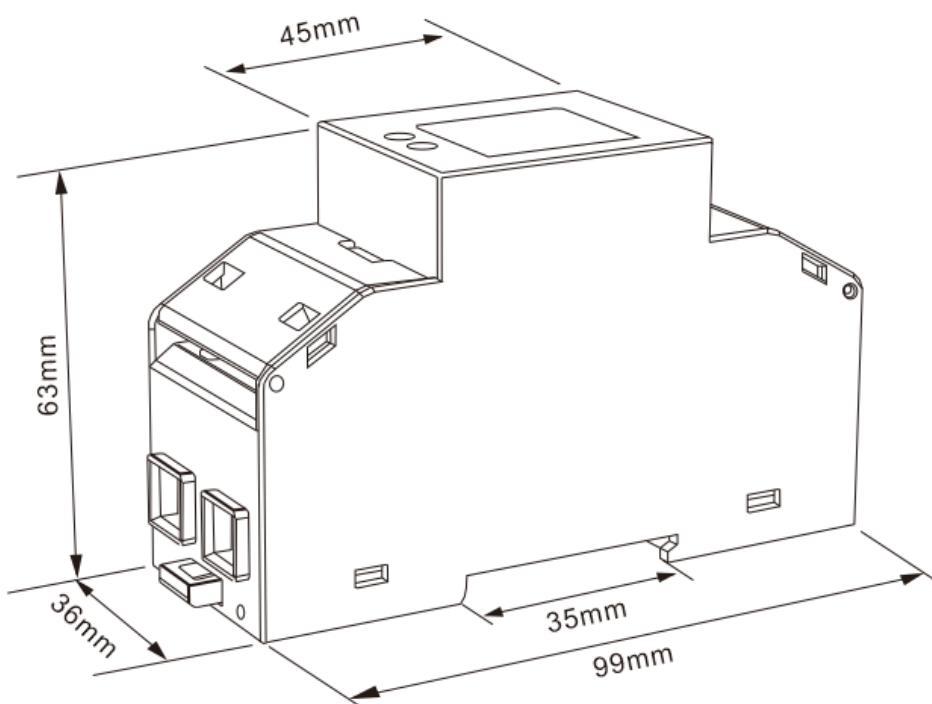

Installation

