

Operating Manual UFR1001E

updated: 2019-07-31/Ba
 from Firmware: 0-12

- NA-protection according to VDE-AR-N 4105:2011+2018-11, power generators at the low voltage grid, TAR medium voltage VDE-AR-N 4110:2018-11
- for use in power generators at the medium voltage grid
- with selectable vector shift detection and Rate of Change of Frequency (ROCOF,df/dt)



Firmware 0-10:

Default setting program 2 for low voltage VDE-AR-N 4105:2018-11
 4 new programs (11-14) for medium voltage according to 4110:2018-11,
 new 2-stage test-mode in all programs

New Firmware 0-11:

for using integrated switches, the feedback contact monitoring **ErEL** in Pr2
 can be switched off

New Firmware 0-12:

New default setting Pr11-14 VDE-AR-N 4110:2018-11

(Display of the firmware version: **Info** → **Fnr** or press "Set" for >10s)

Certificates see:

<https://www.ziehl.com/en/products/detail/UFR1001E-54>

Table of contents

| | | |
|-----------|--|-----------|
| 1 | General Notes | 4 |
| 2 | Display and controls | 4 |
| 3 | Default settings and firmware version, VDE-AR-N 4105 + BDEW | 6 |
| 4 | Default settings and firmware version, VDE-AR-N 4110:2018-11 | 8 |
| 5 | Default settings and firmware version, ÖVE/ÖNORM E 8001-4-712, VSE/EE A-CH 2014, G98(83/2)+G99(G59/3) | 10 |
| 6 | Application and brief description | 12 |
| 7 | Summary of the functions | 12 |
| 8 | Connection diagrams | 13 |
| 8.1 | 1x PV, 1x section switch (VDE-AR-N 4105:2018-11) | 13 |
| 8.2 | 1x PV, 2x section switch (VDE-AR-N 4105:2011) | 14 |
| 8.3 | Multiple PV with section switch and with a series-switched NC's as feedback contacts | 15 |
| 8.4 | Multiple PV with section switch and with a parallel-switched closing contacts as feedback | 16 |
| 8.5 | 1x PV, 1x section switch with nc/normally closed contacts (medium voltage) | 17 |
| 8.6 | Using integrated switches of PV and battery inverters according to DIN EN 62109 (VDE 0126-4) | 18 |
| 9 | Important information | 19 |
| 10 | Assembly | 19 |
| 11 | Detailed description | 20 |
| 11.1 | Description of the connections | 20 |
| 11.2 | Functional characteristics | 21 |
| 12 | Commissioning | 22 |
| 12.1 | Program setup | 22 |
| 12.2 | Control chart Pr 2-6, 11-14, 20-23 | 23 |
| 12.3 | Control chart Pr 1, 7, 10, 15 | 24 |
| 12.4 | Description of the parameters | 25 |
| 12.5 | Display mode (last decimal point off) | 26 |
| 12.6 | Menu mode (last decimal point on) | 26 |
| 12.7 | Configuration mode (last decimal point flashes) | 26 |
| 12.8 | Test mode (timekeeping only activated and connected feedback contacts) | 26 |
| 12.9 | Alarm counter | 27 |
| 12.10 | Cumulative alarm time (display in hours) | 27 |
| 12.11 | Alarm memory | 27 |
| 12.12 | Standby counter and standby time | 28 |
| 12.13 | Code lock | 28 |
| 12.14 | Sealing | 29 |
| 12.15 | Simulation | 29 |
| 12.16 | Possible indications in display | 30 |
| 13 | Technical Data | 31 |
| 14 | Maintenance and repair | 32 |
| 15 | Troubleshooting and measures | 33 |
| 16 | Construction form V6 | 34 |

| | | |
|----|---|----|
| 17 | Disposal | 34 |
| 18 | Adjustment values table VDE-AR-N 4105:2011, Low Voltage Pr 1+7 | 35 |
| 19 | Adjustment values table BDEW June 2008, acc 3.2.3.3-1, Medium Voltage Pr 3-6 | 35 |
| 20 | Adjustment values table VDE-AR-N 4105:2018-11,Low Voltage 6. table 2, Pr 2..... | 35 |
| 21 | Adjustment values VDE-AR-N 4110:2018-11, Medium Voltage higher protection Pr 11+12..... | 36 |
| 22 | Adjustment values VDE-AR-N 4110:2018-11, Medium Voltage Unit Protection Pr 13+14..... | 36 |

1 General Notes

Compliance with the following instructions is mandatory to ensure the functionality and safety of the product. If the following instructions given especially but not limited for general safety, transport, storage, mounting, operating conditions, start-up and disposal / recycling are not observed, the product may not operate safely and may cause a hazard to the life and limb of users and third parties. Deviations from the following requirements may therefore lead both to the loss of the statutory material defect liability rights and to the liability of the buyer for the product that has become unsafe due to the deviation from the specifications.

2 Display and controls

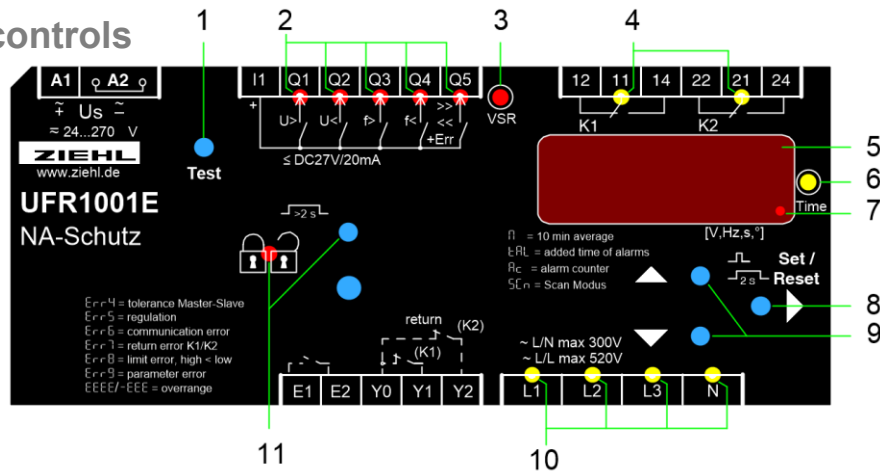

1 Test button

| | |
|---------------|--|
| Press briefly | Display test-menu Relay K1 ($\pm 5\% I$) or relay K2 ($\pm 5\% I^2$) can be tested independently. (3min without a button is pressed = go back to the normal mode) |
|---------------|--|

2 LEDs frequency / voltage limit value undercut / exceeded (red)

| | |
|---------------------------------------|--------------------------------------|
| On, RL or RL Π | Limit value undercut / exceeded |
| FLASHES, RL or RL Π | Reset delay Δt counting down |

3 LED vector surge (VSR, red)

| | |
|--------------------|---|
| ON, RL | Threshold value for vector shift exceeded |
| FLASHES, RL | Reset delay Δt counting down |

4 LEDs relay status (yellow)

| | |
|-----|-------------------|
| OFF | Relay is released |
| ON | Relay operating |

5 Digital display 4-digits (red)

| |
|--|
| Depending on program, display of current voltage, frequency, vector shift, average value |
| Displays the alarm signals, e.g. RL , RL Π |
| Displays the errors with error code e.g. Err9 |

6 LED Time (yellow)

| | |
|----|---------------------|
| ON | A time is displayed |
|----|---------------------|

7 Last decimal point (red)

| | |
|-------------|--------------------|
| OFF | Display mode |
| Illuminated | Menu mode |
| Flashes | Configuration mode |

8 Set/Reset key (in display mode, normal state)

| | |
|------------------|---|
| Press briefly | Display of next measured value / alarm counter |
| Press for > 2 s | Reset, quit error messages |
| Press for > 4 s | Displays the program, e.g. Pr 1 |
| Press for > 10 s | Displays the software version, e.g. 0-05 |

9 Up / Down key (in display mode, normal state)

| | |
|-----------------|---|
| Press briefly | Change to the menu mode, display of alarm memory (Down) / cumulative time of alarms, standby counter, standby time (Up), pushing Set button for ≥ 2 s resets the stored values |
| Press for > 2 s | Display of MAX (Up) / MIN (Down) - measured values, additional pushing of Set button for ≥ 2 s deletes the stored values |

10 LEDs measurement allocation (yellow)

| LEDs | Measured value |
|---------------------|---|
| Lx and N ON | Voltage value (L1 against N, L2 against N, L3 against N) |
| Lx and Ly ON | Voltage value (L1 against L2, L2 against L3, L1 against L3) |
| Lx FLASHING quickly | Vector surge (L1, L2, L3) |
| L1 FLASHING | Frequency |

11 Sealable button + LED  

| | |
|---|---|
| Press for > 2 s | Lock / Unlock |
|  LED red | Settings and simulation mode are locked, While attempting to set, Loc is displayed for 3s |
| LED green | Setting and simulation enabled |

3 Default settings and firmware version, VDE-AR-N 4105 + BDEW

When changing programs, all parameters are reset to the default settings.

| Menu | Parameter / Unit | | Default settings  | | | | | | | Users Data |
|----------------|------------------|----------------------|--|-------------------|-------------------|---------------------|--------------------|-----------------------|--------------------|-------------------|
| | | | Low voltage VDE-AR-N 4105: | | | Medium voltage BDEW | | | | |
| | | | 2011 | 2018 | 2011 | 3 AC +N 230V | 3 AC +N 100V | 3/2/1AC +N 230V | 3 AC +N 400V | |
| | | | Pr1 | Pr2 * | Pr7 | Pr3 | Pr4 | Pr5 | Pr6 | |
| 59.S2 59>S2 | U [~] | Alarm on/off | - | on | - | on | on | on | on | |
| | U [~] | Overvoltage | V | - | 287 | - | 66.4 | 115 | 264 | 458 |
| | H [~] | Hysteresis | V | - | 35.0 | - | 1.0 | 1.0 | 3.0 | 3.0 |
| | dRL | Response time | s | - | 0.10 | - | 0.10 | 0.10 | 0.10 | 0.10 |
| | doF | OFF-delay | s | - | 60 | - | 60 | 60 | 60 | 60 |
| 59.S1 59>S1 | U ⁻ | Alarm on/off | | on | oFF | on | on | on | on | on |
| | U ⁻ | Overvoltage | V | 264 | 264 | 264 | 62.3 | 108 | 249 | 430 |
| | H ⁻ | Hysteresis | V | 5.0 | 12.0 | 5.0 | 1.0 | 1.0 | 3.0 | 3.0 |
| | dRL | Response time | s | 0.10 | 0.10 | 0.10 | 60.0 | 60.0 | 60.0 | 60.0 |
| | doF | OFF-delay | s | 60 | 60 | 60 | 60 | 60 | 60 | 60 |
| 59-Av | U ⁿ | Alarm on/off | | on | on | on | oFF | oFF | oFF | oFF |
| | U ⁿ | Overvoltage | V | 253 | 253 ³ | 253 | 63.5 | 110 | 253 | 438 |
| | H ⁿ | Hysteresis | V | 3.0 | 5.0 | 3.0 | 1.0 | 1.0 | 3.0 | 3.0 |
| | dRL | Response time | s | 0.10 | 0.10 | 0.10 | 0.10 | 0.10 | 0.10 | 0.10 |
| | doF | OFF-delay | s | 60 | 60 | 60 | 60 | 60 | 60 | 60 |
| 27.S1 27<S1 | U ₋ | Alarm on/off | | on | on | on | on | on | on | on |
| | U ₋ | Undervoltage | V | 184 | 184 | 184 | 46.2 | 80.0 | 184 | 318 |
| | H ₋ | Hysteresis | V | 5.0 | 12.0 | 5.0 | 1.0 | 1.0 | 3.0 | 3.0 |
| | dRL | Response time | s | 0.10 | 3.00 ³ | 0.10 | 2.70 | 2.70 | 2.70 | 2.70 |
| | doF | OFF-delay | s | 60 | 60 | 60 | 60 | 60 | 60 | 60 |
| 27.S2 27<S2 | U ₋₋ | Alarm on/off | | - | on | - | oFF | oFF | oFF | oFF |
| | U ₋₋ | Undervoltage | V | - | 103 | - | 26.0 | 45.0 | 104 | 180 |
| | H ₋₋ | Hysteresis | V | - | 93.0 | - | 1.0 | 1.0 | 2.0 | 2.0 |
| | dRL | Response time | s | - | 0.30 ³ | - | 0.30 | 0.30 | 0.30 | 0.30 |
| | doF | OFF-delay | s | - | 60 | - | 60 | 60 | 60 | 60 |
| 81.S2 81>S2 | F [~] | Alarm on/off | | - | oFF | - | oFF | oFF | oFF | oFF |
| | F [~] | Overfrequency | Hz | - | 52.50 | - | 51.50 | 51.50 | 51.50 | 51.50 |
| | H [~] | Hysteresis | Hz | - | 2.40 ² | - | 1.45 ¹ | 1.45 ¹ | 1.45 ¹ | 1.45 ¹ |
| | dRL | Response time | s | - | 0.10 | - | 0.10 | 0.10 | 0.10 | 0.10 |
| | doF | OFF-delay | s | - | 60 | - | 60 | 60 | 60 | 60 |
| 81.S1 81>S1 | F ⁻ | Alarm on/off | | on | on | on | on | on | on | on |
| | F ⁻ | Overfrequency | Hz | 51.50 | 51.50 | 51.50 | 51.50 | 51.50 | 51.50 | 51.50 |
| | H ⁻ | Hysteresis | Hz | 1.45 ¹ | 1.40 ² | 1.45 ¹ | 1.45 ¹ | 1.45 ¹ | 1.45 ¹ | 1.45 ¹ |
| | dRL | Response time | s | 0.10 | 0.10 | 0.10 | 0.10 | 0.10 | 0.10 | 0.10 |
| | U [~] | Alarm on/off | s | 60 | 60 | 60 | 60 | 60 | 60 | 60 |

* factory preset

¹ = Autohysteresis 50,05 Hz

² = Autohysteresis 50,10 Hz

³ = Parameter can be changed without unlocking code lock (Pr2 only)

Display of the program: I n F o → Pr or when switching on

Display of the firmware version: I n F o → F n r

| Menu | Parameter / Unit | | Default settings  | | | | | | | Users Data | | | |
|-----------------------------------|------------------|--------------------------|---|-------|------------------|---|--------------------|----------------------|---------------------|------------|--------------|-----------------------|--------------|
| | | | Low voltage VDE-AR-N 4105: | | | Medium voltage VDE-AR-N 4110:2018-11 | | | | | | | |
| | | | 2011 | 2018 | 2011 | 3 AC +N 230V | 3 AC +N 230V | 2/1 AC +N 230V | 3 AC +N 57,7V | | 3 AC 100V | 3/2/1AC +N 230V | 3 AC 400V |
| | | | Pr1 | Pr2 * | Pr1 | Pr3 | Pr4 | Pr5 | Pr6 | | | | |
| F ₋ 81.S1 81<S1 | F ₋ | Alarm on/off | | on | on | on | on | on | on | on | | | |
| | F ₋ | Underfrequency | Hz | 47.50 | 47.50 | 47.50 | 47.50 | 47.50 | 47.50 | 47.50 | | | |
| | H ₋ | Hysteresis | Hz | 1.00 | 0.10 | 1.00 | 1.00 | 1.00 | 1.00 | 1.00 | | | |
| | dRL | Response time | s | 0.10 | 0.10 | 0.10 | 0.10 | 0.10 | 0.10 | 0.10 | | | |
| | doF | OFF-delay | s | 60 | 60 | 60 | 60 | 60 | 60 | 60 | | | |
| F ₋₋ 81.S2 81<S2 | F ₋₋ | Alarm on/off | | - | oFF | - | oFF | oFF | oFF | oFF | | | |
| | F ₋₋ | Underfrequency | Hz | - | 47.00 | - | 47.50 | 47.50 | 47.50 | 47.50 | | | |
| | H ₋₋ | Hysteresis | Hz | - | 0.60 | - | 1.00 | 1.00 | 1.00 | 1.00 | | | |
| | dRL | Response time | s | - | 0.10 | - | 0.10 | 0.10 | 0.10 | 0.10 | | | |
| | doF | OFF-delay | s | - | 60 | - | 60 | 60 | 60 | 60 | | | |
| UonF | UonF | on/off | | oFF | oFF | oFF | oFF | oFF | oFF | oFF | | | |
| | UonF | voltage | V | 46.0 | 46.0 | 46.0 | 20.0 | 20.0 | 46.0 | 46.0 | | | |
| uSr 78 | uSr | Alarm on/off | | Stby | Stby | Stby | Stby | Stby | Stby | Stby | | | |
| | uSr | Vector shift | ° | 10.0 | 10.0 | 10.0 | 10.0 | 10.0 | 10.0 | 10.0 | | | |
| | doF | OFF-delay | s | 3 | 3 | 3 | 3 | 3 | 3 | 3 | | | |
| | dEon | Suppression time | s | 2 | 2 | 2 | 3 | 3 | 3 | 3 | | | |
| | uSr | Number of phases | | 3Ph | 3Ph | 3Ph | 3Ph | 3Ph | 3Ph | 3Ph | | | |
| rocF 81r | rocF | Alarm on/off | | oFF | oFF | oFF | oFF | oFF | oFF | oFF | | | |
| | dFdt | delta f / delta t | Hz/s | 0.800 | 2.000 | 0.800 | 0.800 | 0.800 | 0.800 | 0.800 | | | |
| | PEr | periods | | 20 | 20 | 20 | 20 | 20 | 20 | 20 | | | |
| | dRL | Response time | s | 0.10 | 0.10 | 0.10 | 0.10 | 0.10 | 0.10 | 0.10 | | | |
| | doF | OFF-delay | s | 60 | 60 | 60 | 60 | 60 | 60 | 60 | | | |
| rEL | trEL | Response time Yx | s | 5.0 | 5.0 ³ | 5.0 | oFF | oFF | oFF | oFF | | | |
| | doFR | Mode | | ind | ind | ind | ind | ind | ind | ind | | | |
| | doFR | Off-delay all | s | 0 | 0 | 0 | 0 | 0 | 0 | 0 | | | |
| ddi | ddi | Display delay | s | 0.5 | 0.5 | 0.5 | 0.5 | 0.5 | 0.5 | 0.5 | | | |
| | dib | Display duration SCn | s | 3.5 | 3.5 | 3.5 | 3.5 | 3.5 | 3.5 | 3.5 | | | |
| Si | U | Voltage | V | 230 | 230 | 230 | 57.7 | 100 | 230 | 400 | | | |
| | F | Frequency | Hz | 50.00 | 50.00 | 50.00 | 50.00 | 50.00 | 50.00 | 50.00 | | | |
| | uSr | Vector shift | ° | 0.0 | 0.0 | 0.0 | 0.0 | 0.0 | 0.0 | 0.0 | | | |
| CodE | Pi n | Pincode | | 504 | 504 | 504 | 504 | 504 | 504 | 504 | | | |
| | CodE | on / off | | oFF | on | oFF | oFF | oFF | oFF | oFF | | | |
| Info | Fnr | Firmware version | | 0-10 | 0-10 | 0-10 | 0-10 | 0-10 | 0-10 | 0-10 | | | |
| | Snr | Serial number | | xxxx | xxxx | xxxx | xxxx | xxxx | xxxx | xxxx | | | |
| | h | Operating hours | h | xxxx | xxxx | xxxx | xxxx | xxxx | xxxx | xxxx | | | |
| | Err | Error counter | | xxx | xxx | xxx | xxx | xxx | xxx | xxx | | | |
| | Pr | Program | | 1 | 2 | 1 | 3 | 4 | 5 | 6 | | | |

* factory preset

Display of the program: Info → Pr or when switching on

Display of the firmware version: Info → Fnr

³ = Parameter can be changed without unlocking code lock (Pr2 only)

4 Default settings and firmware version, VDE-AR-N 4110:2018-11

When changing programs, all parameters are reset to the default settings.

| Menu | Parameter / Unit | | Default settings Medium voltage  VDE-AR-N 4110:2018-11 | | | | Users Data |
|------------------|---------------------------------------|----|--|-------------------------------|--------------------------------|-----------------------|------------|
| | | | 3 AC +N 57,7V Pr 11 | 3 AC 100V Pr 12 | 3/2/1AC +N 230V Pr 13 | 3 AC 400V Pr 14 | |
| | | | U ⁻⁻⁻ | U ⁻⁻⁻ Alarm on/off | | on | |
| 59.S2 59>S2 | U ⁻⁻⁻ Overvoltage | V | 69.2 | 120 | 287 | 498 | |
| | H ⁻⁻⁻ Hysteresis | V | 1.0 | 1.0 | 3.0 | 3.0 | |
| | dRL Response time | s | 0.30 | 0.30 | 0.10 | 0.10 | |
| | doF OFF-delay | s | 60 | 60 | 60 | 60 | |
| U ⁻ | U ⁻ Alarm on/off | | on | on | oFF | oFF | |
| 59.S1 59>S1 | U ⁻ Overvoltage | V | 63.5 | 110 | 249 | 430 | |
| | H ⁻ Hysteresis | V | 1.0 | 1.0 | 3.0 | 3.0 | |
| | dRL Response time | s | 180.0 | 180.0 | 60.0 | 60.0 | |
| | doF OFF-delay | s | 60 | 60 | 60 | 60 | |
| U [∩] | U [∩] Alarm on/off | | oFF | oFF | oFF | oFF | |
| 59-Av | U [∩] Overvoltage | V | 63.5 | 110 | 253 | 438 | |
| | H [∩] Hysteresis | V | 1.0 | 1.0 | 3.0 | 3.0 | |
| | dRL Response time | s | 0.10 | 0.10 | 0.10 | 0.10 | |
| | doF OFF-delay | s | 60 | 60 | 60 | 60 | |
| U ₋ | U ₋ Alarm on/off | | on | on | on | on | |
| 27.S1 27<S1 | U ₋ Undervoltage | V | 46.2 | 80.0 | 184 | 318 | |
| | H ₋ Hysteresis | V | 9.0 | 15.5 | 35.0 | 61.0 | |
| | dRL Response time | s | 2.70 | 2.70 | 1.00 | 1.00 | |
| | doF OFF-delay | s | 60 | 60 | 60 | 60 | |
| U ₋₋ | U ₋₋ Alarm on/off | | oFF | oFF | on | on | |
| 27.S2 27<S2 | U ₋₋ Undervoltage | V | 26.0 | 45.0 | 104 | 179 | |
| | H ₋₋ Hysteresis | V | 29.0 | 50.0 | 115 | 180 | |
| | dRL Response time | s | 0.30 | 0.30 | 0.30 | 0.30 | |
| | doF OFF-delay | s | 60 | 60 | 60 | 60 | |
| F ⁻⁻⁻ | F ⁻⁻⁻ Alarm on/off | | oFF | oFF | on | on | |
| 81.S2 81>S2 | F ⁻⁻⁻ Overfrequency | Hz | 51.50 | 51.50 | 52.50 | 52.50 | |
| | H ⁻⁻⁻ Hysteresis | Hz | 1.40 ² | 1.40 ² | 2.40 ² | 2.40 ² | |
| | dRL Response time | s | 0.10 | 0.10 | 0.10 | 0.10 | |
| | doF OFF-delay | s | 60 | 60 | 60 | 60 | |
| F ⁻ | F ⁻ Alarm on/off | | oFF | oFF | on | on | |
| 81.S1 81>S1 | F ⁻ Overfrequency | Hz | 51.50 | 51.50 | 51.50 | 51.50 | |
| | H ⁻ Hysteresis | Hz | 1.40 ² | 1.40 ² | 1.40 ² | 1.40 ² | |
| | dRL Response time | s | 5.40 | 5.40 | 5.00 | 5.00 | |
| | U ⁻⁻⁻ Alarm on/off | s | 60 | 60 | 60 | 60 | |

² = Autohysteresis 50,10 Hz

Display of the program: I nF o → Pr or when switching on

Display of the firmware version: I nF o → Fnr



| Menu | Parameter / Unit | | Default settings Medium voltage VDE-AR-N 4110:2018-11 | | | | Users Data | |
|-----------------------------------|------------------|--------------------------|---|-------------------|-----------------------|-------------------|-------------------|--|
| | | | 3 AC +N 57,7V | 3 AC 100V | 3/2/1AC +N 230V | 3 AC 400V | | |
| | | | Pr 11 | Pr 12 | Pr 13 | Pr 14 | | |
| F ₋ 81.S1 81<S1 | F ₋ | Alarm on/off | | oFF | oFF | on | on | |
| | F ₋ | Underfrequency | Hz | 47.50 | 47.50 | 47.50 | 47.50 | |
| | H ₋ | Hysteresis | Hz | 2.40 ⁴ | 2.40 ⁴ | 2.40 ⁴ | 2.40 ⁴ | |
| | dRl | Response time | s | 0.40 | 0.40 | 0.10 | 0.10 | |
| | doF | OFF-delay | s | 60 | 60 | 60 | 60 | |
| F ₋₋ 81.S2 81<S2 | F ₋₋ | Alarm on/off | | oFF | oFF | oFF | oFF | |
| | F ₋₋ | Underfrequency | Hz | 47.50 | 47.50 | 47.50 | 47.50 | |
| | H ₋₋ | Hysteresis | Hz | 2.40 ⁴ | 2.40 ⁴ | 2.40 ⁴ | 2.40 ⁴ | |
| | dRl | Response time | s | 0.10 | 0.10 | 0.10 | 0.10 | |
| | doF | OFF-delay | s | 60 | 60 | 60 | 60 | |
| UonF | UonF | on/off | | oFF | oFF | oFF | oFF | |
| | UonF | voltage | V | 20.0 | 20.0 | 46.0 | 46.0 | |
| uSr 78 | uSr | Alarm on/off | | 5tbY | 5tbY | 5tbY | 5tbY | |
| | uSr | Vector shift | ° | 10.0 | 10.0 | 10.0 | 10.0 | |
| | doF | OFF-delay | s | 3 | 3 | 3 | 3 | |
| | dEon | Suppression time | s | 3 | 3 | 3 | 3 | |
| | uSr | Number of phases | | 3Ph | 3Ph | 3Ph | 3Ph | |
| rocF 81r | rocF | Alarm on/off | | oFF | oFF | oFF | oFF | |
| | dFdE | delta f / delta t | Hz/s | 2.000 | 2.000 | 2.000 | 2.000 | |
| | PEr | periods | | 20 | 20 | 20 | 20 | |
| | dRl | Response time | s | 0.10 | 0.10 | 0.10 | 0.10 | |
| | doF | OFF-delay | s | 60 | 60 | 60 | 60 | |
| rEL | ErEL | Response time Yx | s | oFF | oFF | oFF | oFF | |
| | doFA | Mode | | ind | ind | ind | ind | |
| | doFA | Off-delay all | s | 0 | 0 | 0 | 0 | |
| ddi | ddi | Display delay | s | 0.5 | 0.5 | 0.5 | 0.5 | |
| | diE | Display duration 5Cn | s | 3.5 | 3.5 | 3.5 | 3.5 | |
| Si | U | Voltage | V | 57.7 | 100 | 230 | 400 | |
| | F | Frequency | Hz | 50.00 | 50.00 | 50.00 | 50.00 | |
| | uSr | Vector shift | ° | 0.0 | 0.0 | 0.0 | 0.0 | |
| CodE | Pin | Pincode | | 504 | 504 | 504 | 504 | |
| | CodE | on / off | | oFF | oFF | oFF | oFF | |
| InFo | Fnr | Firmware version | | 0-10 | 0-10 | 0-10 | 0-10 | |
| | Snr | Serial number | | xxxx | xxxx | xxxx | xxxx | |
| | h | Operating hours | h | xxxx | xxxx | xxxx | xxxx | |
| | Err | Error counter | | xxx | xxx | xxx | xxx | |
| | Pr | Program | | 11 | 12 | 13 | 14 | |

⁴ = Autohysteresis 49,90 Hz

Display of the program: InFo → Pr or when switching on
Display of the firmware version: InFo → Fnr

5 Default settings and firmware version, ÖVE/ÖNORM E 8001-4-712, VSE/EE A-CH 2014, G98(83/2)+G99(G59/3)

When changing programs, all parameters are reset to the default settings.

| Menu | Parameter / Unit | |  |  | Default settings  | | | | Users Data |
|-----------------|--------------------------------------|----|---|---|--|-------------------|-------------------|-------------------|------------|
| | | | ÖVE/ ÖNORM E 8001- 4-712 | VSE/EE A-CH 2014 | G98(G83/2) + G99(G59/3) | | | | |
| | | | 3AC+N 230V | 3AC+N 230V | 3AC+N 230V * | 3AC 400V * | 3AC+N 63,5V * | 3AC 110V * | |
| | | | Pr 10 | Pr 15 | Pr 20 | Pr 21 | Pr 22 | Pr 23 | |
| U ⁺⁺ | U ⁺⁺ Alarm on/off | | - | - | on | on | on | on | |
| | U ⁺⁺ Overvoltage | V | - | - | 273 | 476 | 717 | 124 | |
| | H ⁺⁺ Hysteresis | V | - | - | 5.0 | 5.0 | 1.0 | 1.0 | |
| | dRL Response time | s | - | - | 0.50 | 0.50 | 0.50 | 0.50 | |
| | doF OFF-delay | s | - | - | 20 | 20 | 20 | 20 | |
| U ⁻ | U ⁻ Alarm on/off | | on | on | on | on | on | on | |
| | U ⁻ Overvoltage | V | 264 | 264 | 262 | 456 | 698 | 121 | |
| | H ⁻ Hysteresis | V | 5.0 | 5.0 | 5.0 | 5.0 | 1.0 | 1.0 | |
| | dRL Response time | s | 0.10 | 0.10 | 1.00 | 1.00 | 1.00 | 1.00 | |
| | doF OFF-delay | s | 30 | 120 | 20 | 20 | 20 | 20 | |
| U ₀ | U ₀ Alarm on/off | | on | on | oFF | oFF | oFF | oFF | |
| | U ₀ Overvoltage | V | 258 | 253 | 262 | 456 | 658 | 121 | |
| | H ₀ Hysteresis | V | 3.0 | 3.0 | 5.0 | 5.0 | 1.0 | 1.0 | |
| | dRL Response time | s | 0.10 | 0.10 | 1.00 | 1.00 | 1.00 | 1.00 | |
| | doF OFF-delay | s | 30 | 120 | 20 | 20 | 20 | 20 | |
| U ₋ | U ₋ Alarm on/off | | on | on | oFF | oFF | oFF | oFF | |
| | U ₋ Undervoltage | V | 184 | 184 | 200 | 348 | 502 | 95.7 | |
| | H ₋ Hysteresis | V | 5.0 | 23.0 | 5.0 | 5.0 | 1.0 | 1.0 | |
| | dRL Response time | s | 0.10 | 0.10 | 2.50 | 2.50 | 2.50 | 2.50 | |
| | doF OFF-delay | s | 30 | 120 | 20 | 20 | 20 | 20 | |
| U _{..} | U _{..} Alarm on/off | | - | - | on | on | on | on | |
| | U _{..} Undervoltage | V | - | - | 184 | 320 | 508 | 88.0 | |
| | H _{..} Hysteresis | V | - | - | 5.0 | 5.0 | 1.0 | 1.0 | |
| | dRL Response time | s | - | - | 2.50 | 2.50 | 2.50 | 2.50 | |
| | doF OFF-delay | s | - | - | 20 | 20 | 20 | 20 | |
| F ⁺⁺ | F ⁺⁺ Alarm on/off | | - | - | on | on | on | on | |
| | F ⁺⁺ Overfrequency | Hz | - | - | 52.00 | 52.00 | 52.00 | 52.00 | |
| | H ⁺⁺ Hysteresis | Hz | - | - | 1.45 ¹ | 1.45 ¹ | 1.45 ¹ | 1.45 ¹ | |
| | dRL Response time | s | - | - | 0.50 | 0.50 | 0.50 | 0.50 | |
| | doF OFF-delay | s | - | - | 20 | 20 | 20 | 20 | |
| F ⁻ | F ⁻ Alarm on/off | | on | on | oFF | oFF | oFF | oFF | |
| | F ⁻ Overfrequency | Hz | 51.50 | 51.50 | 51.50 | 51.50 | 51.50 | 51.50 | |
| | H ⁻ Hysteresis | Hz | 1.45 ¹ | 1.45 ¹ | 1.45 ¹ | 1.45 ¹ | 1.45 ¹ | 1.45 ¹ | |
| | dRL Response time | s | 0.10 | 0.10 | 90.0 | 90.0 | 90.0 | 90.0 | |
| | doF OFF-delay | s | 30 | 120 | 20 | 20 | 20 | 20 | |

* Pr 20 ... Pr 23 for 240/416 V rated voltage change settings of: Voltage x (240V / 230 V)

¹ = Autohysteresis 50.05 Hz

Display of the program:

Info

→

Pr



or when switching on

Display of the firmware version:

Info

→

Fnr

| Menu | Parameter / Unit | |  |  | Default settings  | | | | Users Data | | |
|-----------------|------------------|-----------------------|--|--|---|-------------|----------------|-------------|------------|--|--|
| | | | ÖVE/ ÖNORM E 8001- 4-712 | VSE/EE A-CH 2014 | G98(G83/2) + G99(G59/3) | | | | | | |
| | | | 3AC+N 230V | 3AC+N 230V | 3AC+N 230V | 3AC 400V | 3AC+N 63,5V | 3AC 100V | | | |
| | | | Pr 10 | Pr 15 | Pr 20 | Pr 21 | Pr 22 | Pr 23 | | | |
| F ₋ | F ₋ | Alarm on/off | on | on | on | on | on | on | | | |
| | F ₋ | Underfrequency | Hz | 47.50 | 47.50 | 47.50 | 47.50 | 47.50 | 47.50 | | |
| | H ₋ | Hysteresis | Hz | 1.00 | 1.00 | 1.00 | 1.00 | 1.00 | 1.00 | | |
| | dRL | Response time | s | 0.10 | 0.10 | 20.0 | 20.0 | 20.0 | 20.0 | | |
| | doF | OFF-delay | s | 30 | 120 | 20 | 20 | 20 | 20 | | |
| F ₋₋ | F ₋₋ | Alarm on/off | - | - | on | on | on | on | | | |
| | F ₋₋ | Underfrequency | Hz | - | - | 47.00 | 47.00 | 47.00 | 47.00 | | |
| | H ₋₋ | Hysteresis | Hz | - | - | 1.00 | 1.00 | 1.00 | 1.00 | | |
| | dRL | Response time | s | - | - | 0.50 | 0.50 | 0.50 | 0.50 | | |
| | doF | OFF-delay | s | - | - | 20 | 20 | 20 | 20 | | |
| UonF | UonF | on/off | oFF | on | oFF | oFF | oFF | oFF | | | |
| | UonF | voltage | V | 46.0 | 16.10 | 46.0 | 46.0 | 20.0 | 20.0 | | |
| uSr | uSr | Alarm on/off | StbY | StbY | StbY | StbY | StbY | StbY | | | |
| | uSr | Vector shift | ° | 10.0 | 10.0 | 50.0 | 50.0 | 50.0 | 50.0 | | |
| | doF | OFF-delay | s | 30 | 3 | 20 | 20 | 20 | 20 | | |
| | dEon | Suppression time | s | 2 | 2 | 2 | 2 | 2 | 2 | | |
| | uSr | Number of phases | | 3Ph | 3Ph | 1Ph | 1Ph | 1Ph | 1Ph | | |
| rocF | rocF | Alarm on/off | oFF | oFF | on | on | on | on | | | |
| | dFdt | delta f / delta t | Hz /s | 0.800 | 0.800 | 1.000 | 1.000 | 1.000 | 1.000 | | |
| | PEr | periods | | 20 | 20 | 20 | 20 | 20 | 20 | | |
| | dRL | Response time | s | 0.10 | 0.10 | 0.50 | 0.50 | 0.50 | 0.50 | | |
| | doF | OFF-delay | s | 30 | 60 | 20 | 20 | 20 | 20 | | |
| rEL | ErEL | Response time Yx | s | oFF | 5.0 | oFF | oFF | oFF | oFF | | |
| | doFR | Mode | | ind | ind | ind | ind | ind | ind | | |
| | doFR | Response time all | s | 0 | 0 | 0 | 0 | 0 | 0 | | |
| ddi | ddi | Display delay | s | 0.5 | 0.5 | 0.5 | 0.5 | 0.5 | 0.5 | | |
| | di t SCn | Display duration | s | 3.5 | 3.5 | 3.5 | 3.5 | 3.5 | 3.5 | | |
| Si | U | Voltage | V | 230 | 230 | 230 | 400 | 63.5 | 110 | | |
| | F | Frequency | Hz | 50.00 | 50.00 | 50.00 | 50.00 | 50.00 | 50.00 | | |
| | uSr | Vector shift | ° | 0.0 | 0.0 | 0.0 | 0.0 | 0.0 | 0.0 | | |
| CodE | Pi n | Pincode | | 504 | 504 | 504 | 504 | 504 | 504 | | |
| | CodE | on / off | | oFF | oFF | oFF | oFF | oFF | oFF | | |
| Info | Fnr | Firmware version | | 0- 10 | 0- 10 | 0- 10 | 0- 10 | 0- 10 | 0- 10 | | |
| | Snr | Serial number | | xxxx | xxxx | xxxx | xxxx | xxxx | xxxx | | |
| | h | Operating hours | h | xxxx | xxxx | xxxx | xxxx | xxxx | xxxx | | |
| | Err | Error counter | | xxx | xxx | xxx | xxx | xxx | xxx | | |
| | Pr | Program | | 10 | 15 | 20 | 21 | 22 | 23 | | |

6 Application and brief description

The grid- and plant protection device UFR1001E monitors voltage and frequency in plants for own generation of electricity. It complies with the requirements of VDE-AR-N 4105:2018-11, VDE-AR-N 4110:2018-11, G59/3, G83/2, ÖVE/ÖNORM E 8001-4-712:2009 and other standards for generators connected to the public grid.

The UFR1001E is a dual-channel device and thus one-fault-proof. The function of the output-relays and of the connected switches can be monitored with feed-back contacts. When a connected switch does not switch off, the UFR does not switch on again. When a switch does not switch on it makes 2 restarts and thus improves availability of monitored plant.

The limits are pre-set according to VDE-AR-N 4105_2011-08, VDE-AR-N 4105:2011-11 and other standards. They can be changed if required and be protected with a code and/or a seal.

With a test-button the function of the connected switches can be tested and their switching-time can be measured.

The standby input allows a remote shutoff e.g. with a RCR.

7 Summary of the functions

- Under and overvoltage monitoring 15...520 V
- Measuring phase-neutral or phase-phase
- Monitoring of under- and overfrequency 45...65 Hz
- Monitoring of quality of voltage (10-minutes-average)
- Monitoring of vector shift 2...65°
- Monitoring of rate of change of frequency (ROCOF, df/dt) 0,100...5,000 Hz/s
- One-fault-proof with monitoring of connected switches (defeatable when using the integrated switch of pv and battery inverter acc. to DIN EN 62109 (VDE 0126-4))
- 2 automatic restarts at switch-on error
- Passive anti-islanding protection acc. to ch. 6.5.3 and app. D2
- Switching delay adjustable 0.05 ... 300 s
- Switching back delay adjustable 0 ... 6.000 s
- Switching back delay at alarms <3 s: 5 s

Preset values acc. to

- VDE-AR-N 4105:2018-11 (Pr2), VDE-AR-N 4105_2011-08 (Pr1)
- VDE-AR-N 4110:2018-11 (PR11-14) and BDEW (Pr 3-6)
- G59/3 and G83/2 for Great Britain
- ÖVE standard for Austria
- VSE/EEA-CH 2014 for Switzerland
- Alarm counter for 100 alarms (trip value, cause and rel. time stamp)
- Record of added times of alarms
- Input for standby with counter and recording of time
- Test button and simulation with measuring of switching-times
- Sealing, all values can be read-out when sealed
- Easy installation and programming with pre-set programs
- Housing for DIN-rail-mount, 105 mm wide, mounting height 66 mm

8 Connection diagrams

8.1 1x PV, 1x section switch (VDE-AR-N 4105:2018-11)

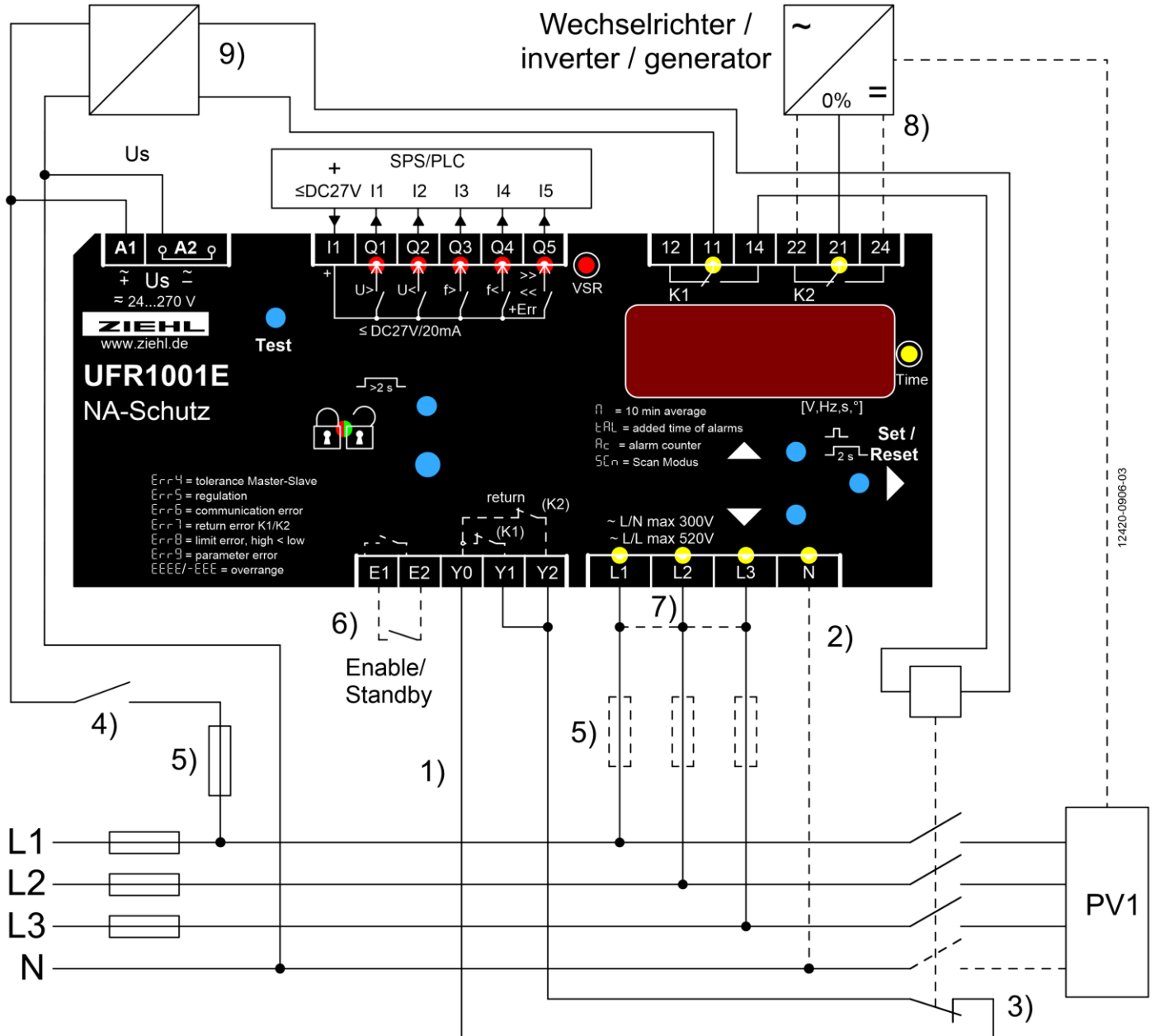

12420-0906-03

- 1) Feedback contacts not connected: set rEL → t_rEL → **off**.
- 2) N connected → only for programs with N
- 3) NC- or NO-contacts can be connected, self-learning when switching on
- 4) Switch off of plant without recording an alarm, e.g. with contact of a ripple control receiver
- 5) Fuses only when line protection necessary, e.g. 16 A
- 6) Contact closed an $u5r$ → $5tby$ (default setting) = Standby, K1+2 switched-off (e.g. by ripple control receiver or clock,...)
 Contact closed and $u5r$ → **on** = repressed vector shifts (e.g. when switching on ...),
 contact closed and $u5r$ → $y1y2$ = no evaluation of the feedback contacts (e.g. for synchronisation, ...)
- 7) 1 phase Application connect L1-L2-L3, 2 phase Application L1 / L2+L3 (only Pr 5, 7, 10, 13, 20)
- 8) Additional switch-off of self generation plant.
 Single-fault safety: shutdown of the self generation plant e.g. by ripple control input 0% with K2. Use coupling relays for contact multiplication if safe isolation is required.
 This second shutdown path must be tested separately during commissioning. ($t5t2$)
- 9) Power supply / buffering. Switches have to withstand undervoltage for min.3 s (FRT)

8.2 1x PV, 2x section switch (VDE-AR-N 4105:2011)

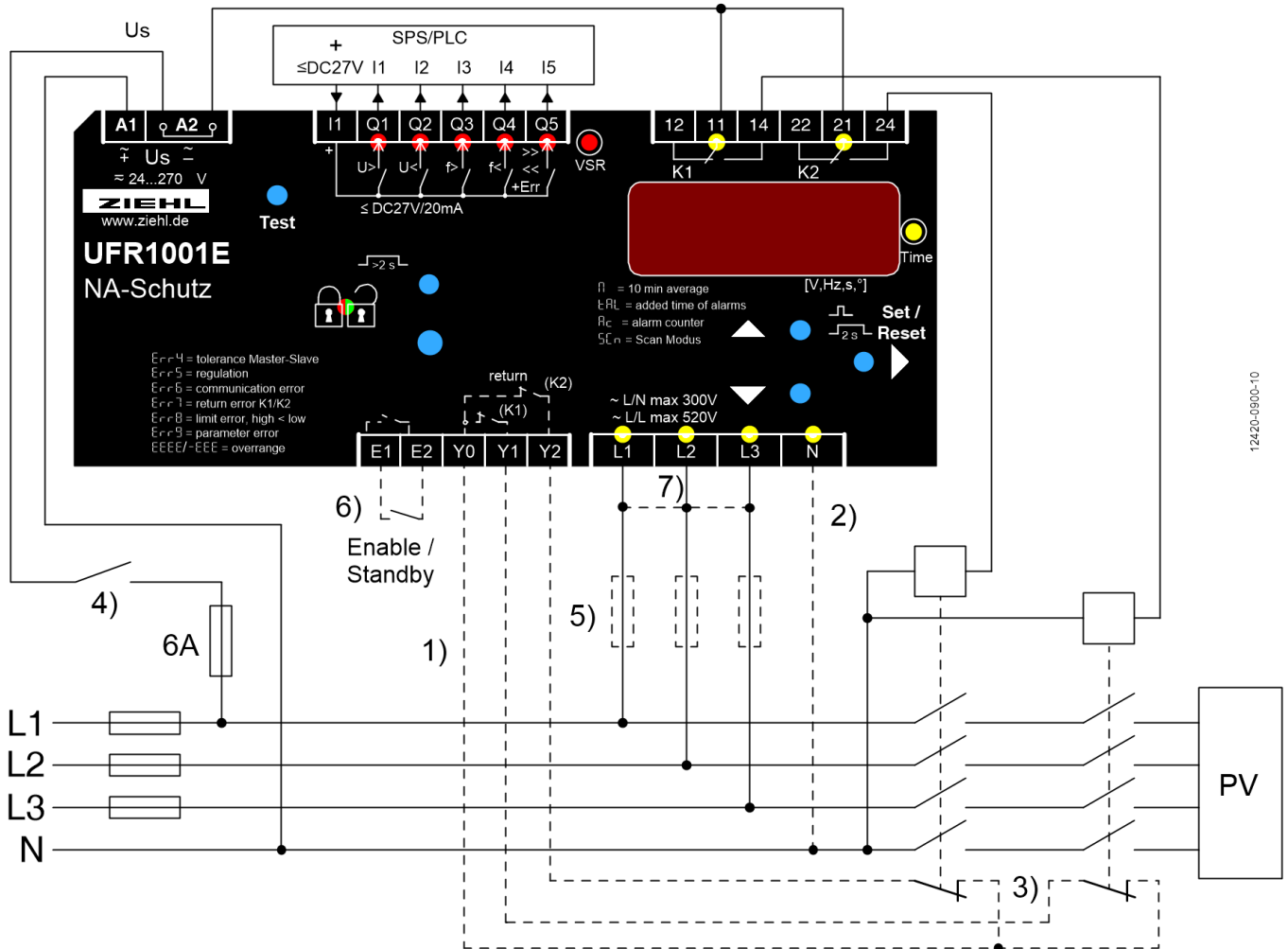

12420-0900-10

- 1) Feedback contacts not connected: set rEL → t_rEL → **off**.
- 2) N connected → only for programs with N
- 3) NC- or NO-contacts can be connected, self-learning when switching on
- 4) Switch off of plant without recording an alarm, e.g. with contact of a ripple control receiver
- 5) Fuses only when line protection necessary, e.g. 3x16A
- 6) Contact closed an $u5r$ → **5tbY** (default setting) = Standby, K1+2 switched-off (e.g. by ripple control receiver or clock,...)
 Contact closed and $u5r$ → **on** = repressed vector shifts (e.g. when switching on ...),
 contact closed and $u5r$ → **Y1Y2** = no evaluation of the feedback contacts (e.g. for synchronisation, ...)
- 7) 1 phase Application connect L1-L2-L3, 2 phase Application L1 / L2+L3 (only Pr 5, 7, 10, 13, 20)

8.3 Multiple PV with section switch and with a series-switched NC's as feedback contacts (expanded inventory plant)

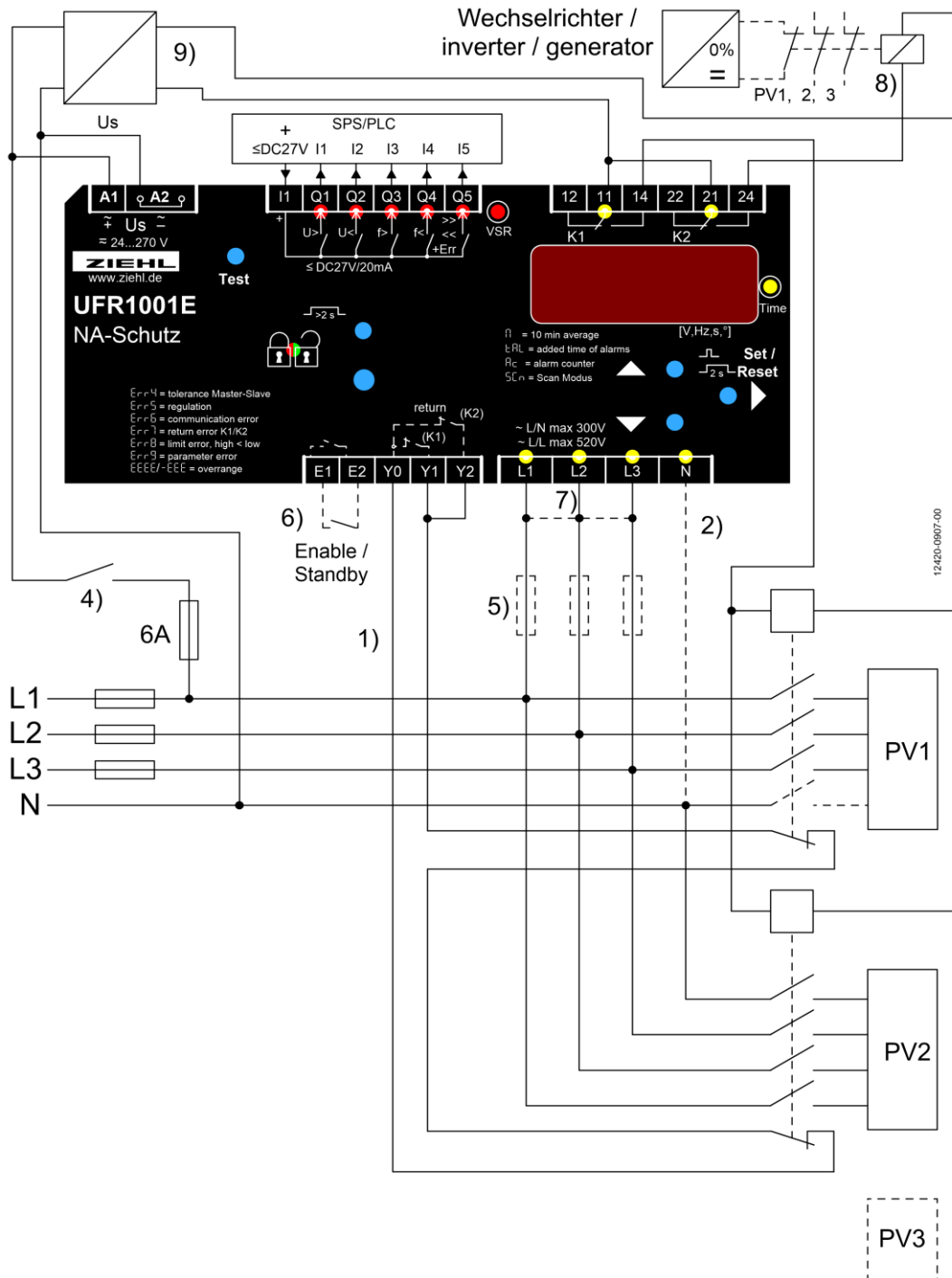

- 1) Contactor feedback contacts Y1/Y2 not connected set **rEL** → **t_rEL** → **off**.
- 2) N connected → only for programs with N
- 4) Switch off the plant without recording an alarm, e.g. with output contact of a ripple control receiver
- 5) Fuses only when line protection necessary, e.g. 3x16A
- 6) Contact closed an **u5r** → **5t6Y** (default setting) = Standby, K1+2 switched-off (e.g. by ripple control receiver or clock,...)
 Contact closed and **u5r** → **on** = repressed vector shifts (e.g. when switching on ...),
 contact closed and **u5r** → **Y1Y2** = no evaluation of the feedback contacts (e.g. for synchronisation, ...)
- 7) 1 phase Application connect L1-L2-L3, 2 phase Application L1 / L2+L3 (only Pr 5, 7, 10, 13, 20)
- 8) Additional switch-off of self generating plant.
 Single-fault safety: shutdown of the self generation plant e.g. by ripple control input 0% with K2. Use coupling relays for contact multiplication of if safe isolation is required.
 This second shutdown path must be tested separately during commissioning. (**t5t2**)
- 9) Power supply / buffering. Switches have to withstand undervoltage for min.3 s (FRT)

8.4 Multiple PV with section switch and with a parallel-switched closing contacts as feedback

(expanded inventory plant)

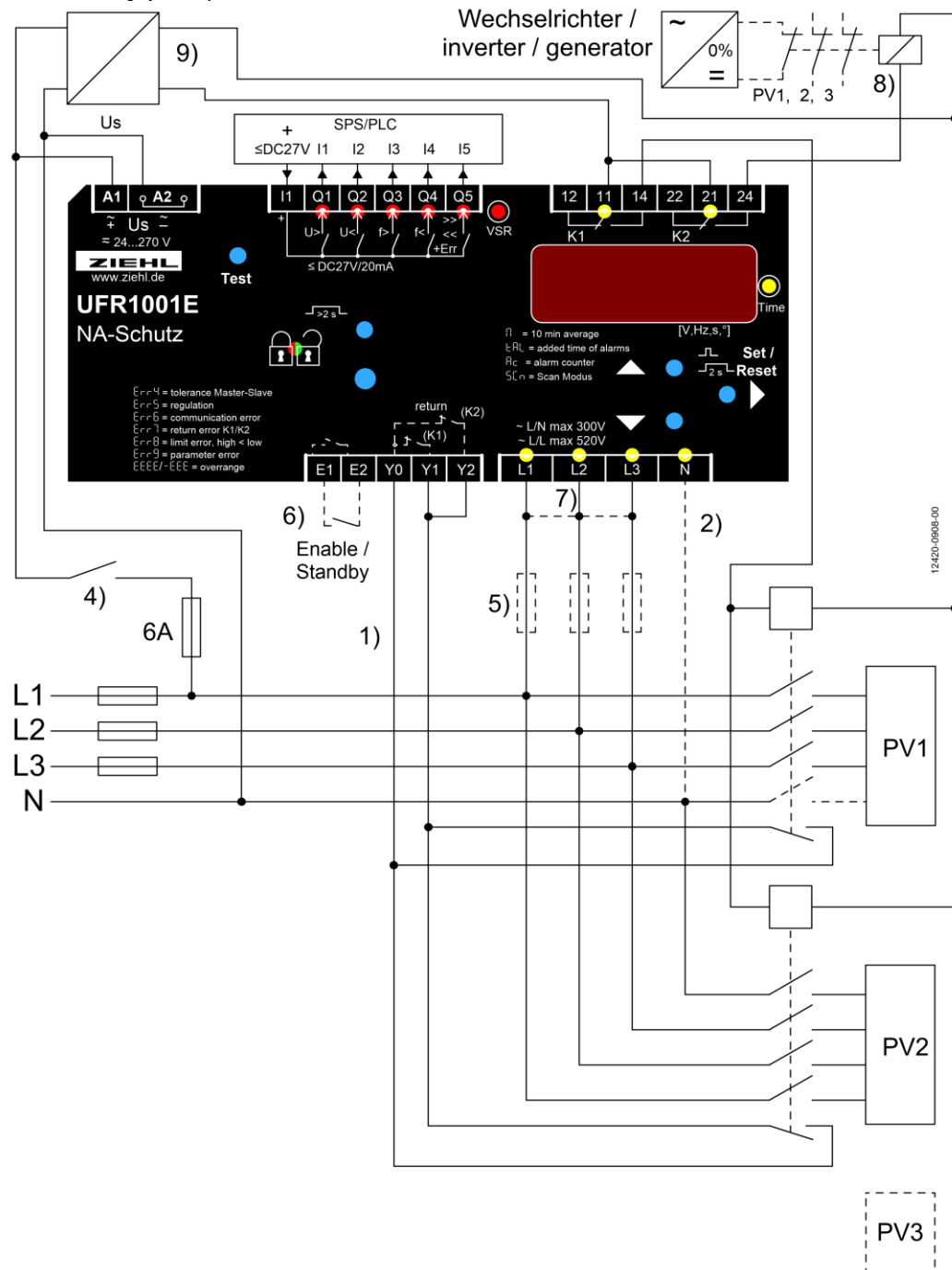

- 1) Feedback contacts Y1/Y2 not connected set $rEL . \rightarrow t rEL . \rightarrow OFF .$
- 2) N connected \rightarrow only for programs with N
- 4) Switch off the plant without recording an alarm, e.g. with output contact of a ripple control receiver
- 5) Fuses only when line protection necessary, e.g. 3x16A
- 6) Contact closed an $u5r . \rightarrow 5t b3 .$ (default setting) = Standby, K1+2 switched-off (e.g. by ripple control receiver or clock,...)
Contact closed and $u5r . \rightarrow on .$ = repressed vector shifts (e.g. when switching on ...),
contact closed and $u5r . \rightarrow 4 12 .$ = no evaluation of the feedback contacts (e.g. for synchronisation, ...)
- 7) 1 phase Application connect L1-L2-L3, 2 phase Application L1 / L2+L3 (only Pr 5, 7, 10, 13, 20)
- 8) Additional switch-off of self generating plant.
Single-fault safety: shutdown of the self generation plant e.g. by ripple control input 0% with K2. Use coupling relays for contact multiplication if safe isolation is required.
This second shutdown path must be tested separately during commissioning. ($t5t2$)
- 9) Power supply / buffering. Switches have to withstand undervoltage for min.3 s (FRT)

8.6 Using integrated switches of PV and battery inverters according to DIN EN 62109 (VDE 0126-4)

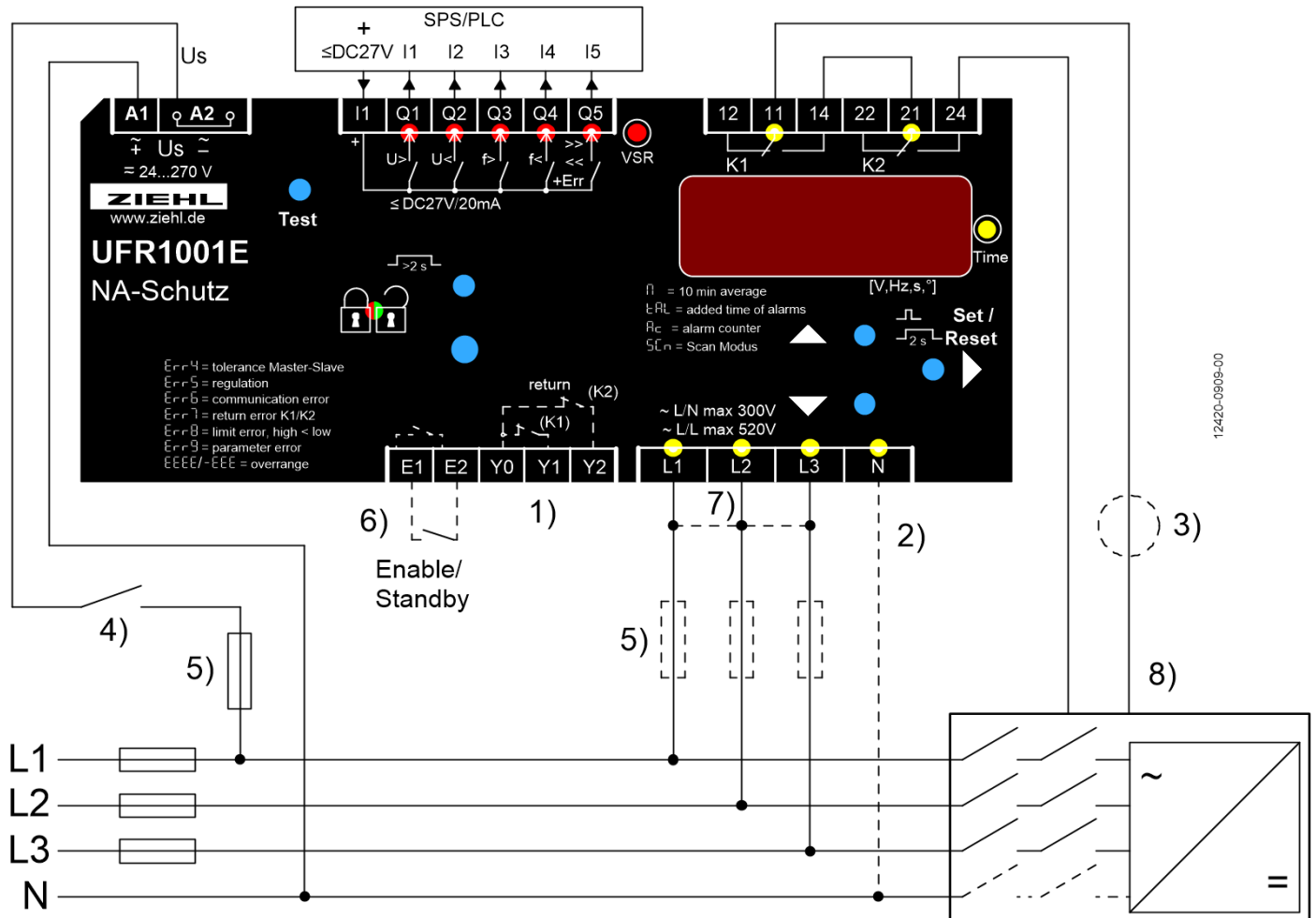

Wechselrichter mit integrierten AC Schaltern /
inverter with integrated AC switches

- 1) Feedback contacts Y1/Y2 not connected set rEL → $t rEL$ → **off**.
- 2) N connected → only for programs with N
- 3) If the inverter requires an external power source
- 4) Switch off the plant without recording an alarm, e.g. with output contact of a ripple control receiver
- 5) Fuses only when line protection necessary, e.g. 3x16A
- 6) Contact closed an $u5r$ → **5t6y**. (default setting) = Standby, K1+2 switched-off (e.g. by ripple control receiver or clock,...)
Contact closed and $u5r$ → **on** = repressed vector shifts (e.g. when switching on ...),
contact closed and $u5r$ → **y1y2** = no evaluation of the feedback contacts (e.g. for synchronisation, ...)
- 7) 1 phase Application connect L1-L2-L3, 2 phase Application L1 / L2+L3 (only Pr 5, 7, 10, 13, 20)
- 8) non-islanding inverters acc. to DIN EN 62109 (VDE 1026-4) with integrated AC switches (internally monitored), approved according to VDE-AR-N 4105:2018-11

9 Important information



A marked switch and a protective device must be provided in the supply line in the vicinity of the device (easily accessible) as a disconnecting element.

Flawless and safe operation of such a device requires proper transport and storage, professional installation and later commissioning along with operation as intended.

Only persons who are familiar with the installation, commissioning and operation of the device and who are correspondingly qualified for their job are permitted to work on the device. They must comply with the contents of the operating manual, the instructions attached to the device and the pertinent safety regulations for the erection and operation of electrical equipment.

The devices are built and certified in accordance with EN 60255 and leave the factory in a safe and technically flawless condition. To maintain this condition they must comply with the safety regulations marked in the operating manual with the headline "Caution". Failure to follow the safety regulations can lead to death, bodily injury or property damage to the device itself and to other devices and equipment.

If the information contained in the operating instructions/operating manual are not sufficient, please contact us directly or contact your responsible agency or representative.

Instead of the industrial norms and stipulations stated in the operating manual and applicable in Europe you must comply with the valid and applicable regulations in the country of utilisation if the device is used outside of the area of application.



WARNING

Hazards electrical voltage!

Can lead to an electric shock and burns.

Disconnect and de-energize before working on the system and the device.

Comply with the maximum permissible temperature when installing in a switch cabinet. Ensure sufficient clearance to other devices or heat sources. If cooling is inhibited, e.g., through close proximity to devices with increased surface temperature or interference with the cooling-air current, the permissible ambient temperature is decreased.



Caution!

Before you apply mains voltage to the device, make sure that the permissible control voltage **Us** on the side rating plate matches the mains voltage connected to the device!

10 Assembly

The device can be mounted:

- Distribution panel or control panel on 35 mm rail according to EN 60715

11 Detailed description

11.1 Description of the connections

| Connection | Description |
|---|--|
| A1 and A2 | Rated control supply voltage U_s , see Technical Data |
| 11, 12, 14; 21, 22, 24 | Relay K1 and K2 |
| E1 – E2 Enable – Input | Volt-free contact |
| | $u5r$ → oFF , no function |
| | $u5r$ → on , E1-E2 closed: Vector shift active but not evaluated, monitoring of feedback contacts off for use with generator (mains synchronization) |
| | $u5r$ → $StBY$, E1-E2 closed: K1 and K2 off (standby), vector shift off |
| Y0, Y1, Y2 Inputs, feedback contacts | Volt-free n/o or n/c contact, self-learning when switching on |
| | Set value > turn-on time section switch under rEL → $ErEL$ / can switch-off if not connected or if external devices/switches can activate the section switch (oFF) |
| I1 | Supply voltage for digital outputs, max. 27 V DC |
| Q1...Q4 | Digital output over-/under voltage/-frequency, Q3 + Q4 = ROCOF |
| Q5 | Digital output error, in Programs with >> and << additionally the 2nd threshold value |
| L1, L2, L3, N | Phase L1, L2, L3 and neutral conductor |







11.2 Functional characteristics

| Functional characteristics | Explanation |
|---|---|
| VSR display value | The highest measured value is always displayed. The display value is reset to 0 by deleting the max. value and when resetting into the go (good) state. |
| Delay Enable On time | Runs down when starting the unit and after opening the enable input; during this time there is no evaluation of the vector shift |
| Reset time | When a reset time d_{oF} is running, it is always counted down in the display (shortest one first) |
| Reset | Use the Reset key or interrupt the control voltage for > 2 s (comply with reset delay) |
| Display mode S_{cn} | After the last measurement it switches into the scan mode; this is indicated by the display S_{cn} . All measurements will now be displayed cyclically for the time set in d_{t} . |
| MIN / MAX values | All min and max values are saved zero-voltage maintained (non-volatile). |
| Tripping time (only with feedback contacts connected) | Connecting the feedback contacts enables measuring of the shut-down time. After a tripping test via the test menu (button test) and selection of the trip circuit (see test mode), the respective tripping time is displayed. (Pr2 and Y1+Y2 bridged, display for K1 only) The display duration is max. 3 minutes or until button test is pressed. The display resolution is 1ms. Total shut-down time = Tripping time + Response time d_{RL} . After a shut-down in the simulation mode the total shut-down time is displayed until the button is pressed again) The longer time of both channels is always displayed. |
| Alarm counter | The unit saves max 100 alarms (cause, measurement value, at operating time). The LEDs indicate the cause; the tripping value that led to the alarm each stands in the 7-segment display. Alternately the time difference, current operating time – tripping operating time is displayed. (how long ago the alarm triggered) |
| Cumulative alarm time t_{AL} | The cumulative alarm time TAL indicates how long the relay was switched off due to an alarm. It is recorded with a resolution of 1 minute and only when the control voltage is applied. Query: In the display mode \blacktriangleright button to R_c is displayed. 1x \blacktriangle button = Cumulative alarm time t_{AL} |
| Standby mode $u_{5r} \rightarrow 5t_{bY}$ | If E1-E2 are closed (e.g., by ripple control receiver, timer, dimmer), Relays K1 and K2 are switched off. The number and duration of the shut-downs is recorded. Query: In the display mode \blacktriangleright button to R_c is displayed. 2x \blacktriangle button = Standby counter $5t_{bY}$. 1x \blacktriangle button = Standby time $5t_{bY}$ |
| synchronization mode $u_{5r} \rightarrow 4192$ | If E1-E2 are closed, the evaluation of the feedback contacts is suppressed. That means when using generators, a section switch can be used for mains synchronization. |
| Automatic restart attempts | If there is an error by the feedback contacts E_{rr1} , 2 restart attempts are automatically performed in an interval of 10s. False triggering by undervoltage trips (e.g. during a thunderstorm) do not lead to permanent shut-down. |
| Frequency undervoltage protection U_{onF} | If one of the measured voltages less than U_{onF} , the frequency evaluation is interrupted until all voltages have exceeded U_{onF} . (does not apply to device start / apply of the control voltage) |

12 Commissioning

12.1 Program setup

The suitable program must be set on the UFR1001E in accordance with the application. If the UFR1001E is sealed/locked (red LED illuminated), the sealing has to be deactivated first.

| Pr | Connection | Limit | Voltage | Country / Standard |
|-------|-----------------|---|---------|---|
| * 2 | 3 AC with N | <u>Low voltage</u> 2x over voltage, 2x under voltage 2x over frequency, 2x under frequency 10min average value, 1x vector shift 1x ROCOF | 230V |  VDE-AR-N 4105:2018 |
| 1 | 3 AC with N | <u>Low voltage</u> 1x over voltage, 1x under voltage 1x over frequency, 1x under frequency 10min average value, 1x vector shift 1x ROCOF | 230V |  VDE-AR-N 4105:2011 |
| 7 | 2/1 AC with N | <u>Medium voltage</u> 2x over voltage, 2x under voltage 2x over frequency, 2x under frequency 10min average value, 1x vector shift 1x ROCOF | 57,7V |  VDE-AR-N 4110:2018 (BDEW Juni 2008 by 3.2.3.3-1) |
| 11(3) | 3 AC with N | | 100V | |
| 12(4) | 3 AC without N | | 230V | |
| 13(5) | 3/2/1 AC with N | | 400V | |
| 14(6) | 3 AC without N | | | |
| 10 | 3/2/1 AC with N | 1x over voltage, 1x under voltage 1x over frequency, 1x under frequency 10min average value, 1x vector shift 1x ROCOF | 230V |  ÖVE/ÖNORM E 8001-4-712 |
| 15 | 3 AC with N | | 230V |  VSE/EEA-CH 2014 |
| 20 | 3/2/1 AC with N | 2x over voltage, 2x under voltage 2x over frequency, 2x under frequency 10min average value, 1x vector shift 1x ROCOF | 230V |  G98(G83/2) + G99(G59/3) |
| 21 | 3 AC without N | | 400V | |
| 22 | 3 AC with N | | 63,5V | |
| 23 | 3 AC without N | | 110V | |
| | | | | |







* default setting

Adjustment process:

If present, remove seal (only authorised person)

- Apply control supply voltage at A1-A2
- Slightly lift the key cover and turn 180°
- Actuate the small blue button by firmly pressing the button cover (LED starts flashing) until the green LED  is illuminated.

Sealing is deactivated

- Press  button 1x → display **I nF a.**
 - Press  button 5x → display **Pr l.**
 - Set the program with the buttons  
 - Press  button 1x → display **no.**
 - Press  button 1x → display **9E5.**
 - Press  button
- ⇒ Device resets and starts with the newly selected program

Hint: When changing programs, all parameters of the selected program are reset to “default settings“ (see table „Default settings“). **Only change the parameters after having selected the correct program.**

12.2 Control chart Pr 2-6, 11-14, 20-23

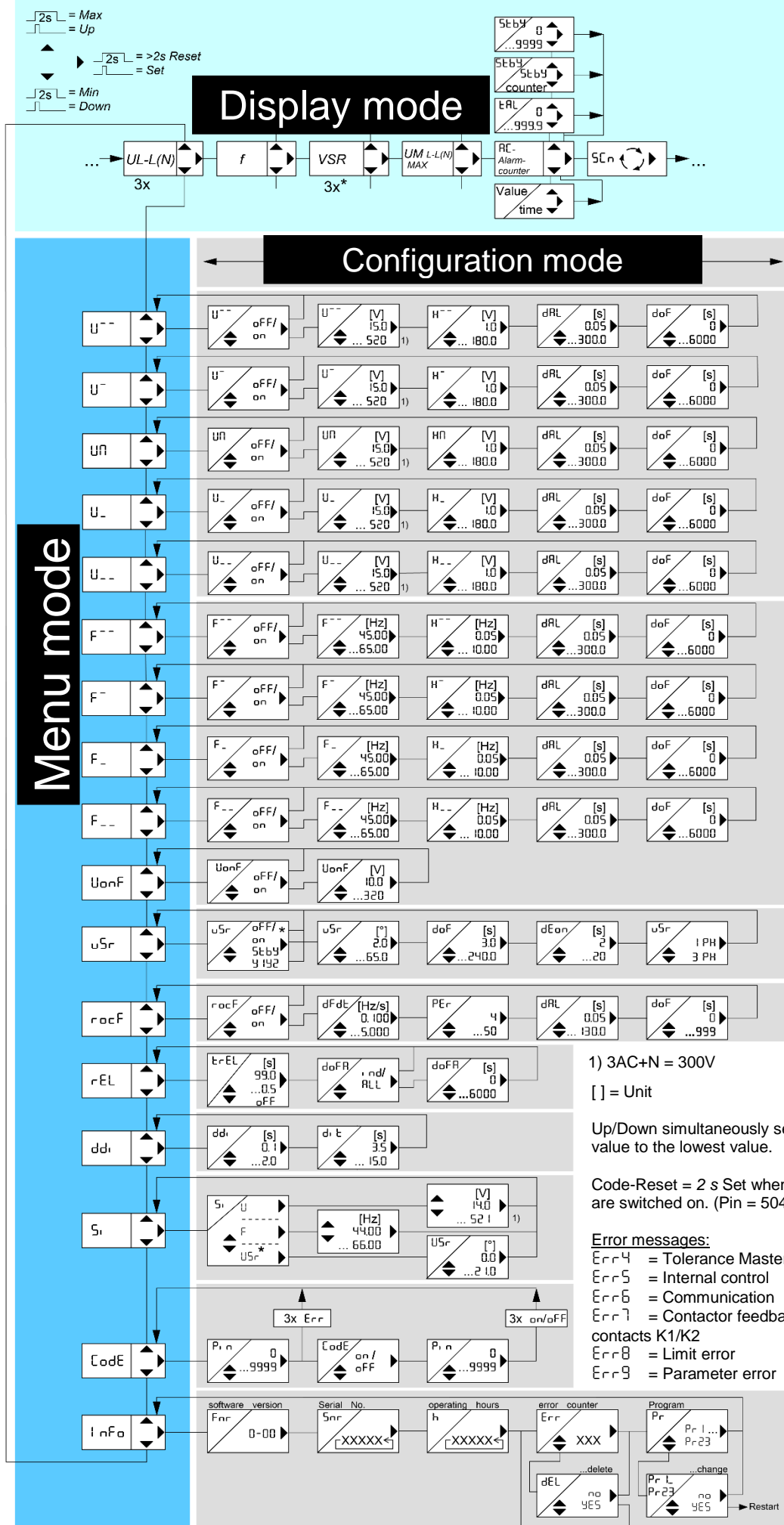

| Pr | Connection | Country / Stand. |
|----|--------------|-------------------------------|
| 2 | 3 AC + N | VDE-AR-N 4105:20 18 |
| 11 | 3 AC + N | VDE-AR-N 4110:20 18 |
| 12 | 3 AC | VDE-AR-N 4110:20 18 |
| 13 | 3/2/1 AC + N | VDE-AR-N 4110:20 18 |
| 14 | 3 AC | VDE-AR-N 4110:20 18 |
| 3 | 3 AC + N | BDEW Juni 2008 nach 3.2.3.3-1 |
| 4 | 3 AC | BDEW Juni 2008 nach 3.2.3.3-1 |
| 5 | 3/2/1 AC + N | BDEW Juni 2008 nach 3.2.3.3-1 |
| 6 | 3 AC | BDEW Juni 2008 nach 3.2.3.3-1 |
| 20 | 3/2/1 AC + N | G98 |
| 21 | 3 AC | G98 |
| 22 | 3 AC + N | (G83/2) + G99 |
| 23 | 3 AC | (G59/3) |

1) 3AC+N = 300V

[] = Unit

Up/Down simultaneously sets the value to the lowest value.

Code-Reset = 2 s Set when mains are switched on. (Pin = 504)

Error messages:

- Err 4 = Tolerance Master Slave
- Err 5 = Internal control
- Err 6 = Communication
- Err 7 = Contactor feedback contacts K1/K2
- Err 8 = Limit error
- Err 9 = Parameter error

12.3 Control chart Pr 1, 7, 10, 15

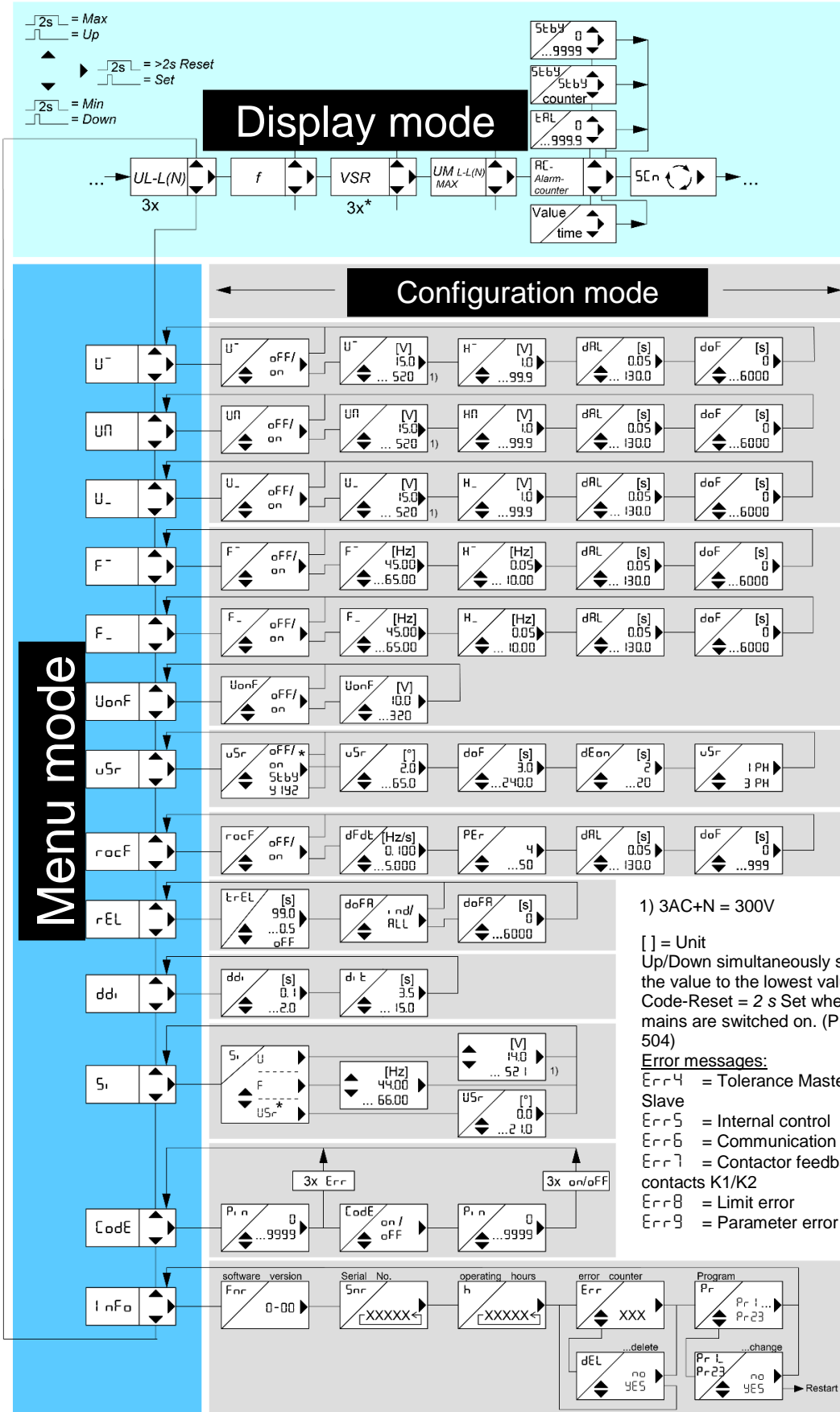

| Pr | Connection | Country / Stand. |
|----|--------------|------------------------|
| 1 | 3 AC + N | VDE-AR-N 4105:201 1 |
| 7 | 2/1 AC + N | ÖVE/ÖNORM E 8001-4-712 |
| 10 | 3/2/1 AC + N | VSE/EE A-CH 2014 |
| 15 | 3 AC + N | VSE/EE A-CH 2014 |

1) 3AC+N = 300V

[] = Unit
 Up/Down simultaneously sets the value to the lowest value.
 Code-Reset = 2 s Set when mains are switched on. (Pin = 504)

Error messages:

- Err4 = Tolerance Master Slave
- Err5 = Internal control
- Err6 = Communication
- Err7 = Contactor feedback contacts K1/K2
- Err8 = Limit error
- Err9 = Parameter error

12.4 Description of the parameters

| Parameters | Display | Explanation | Adjustment range |
|-----------------------------|---|---|----------------------------------|
| Limit value | U ⁻ U ⁻ U ₋ U ₋₋ U _N | Voltage limit value | 15.0 ... 300 15.0 ... 520 |
| Limit value | U _{onF} | Limit value for voltage (L1/2/3 < U _{onF} = frequency protection off) | 10.0 ... 320 |
| Limit value | F ⁻ , F ⁻ , F ₋ , F ₋₋ | Frequency limit value | 45.00 ... 65.00 |
| Limit value | dFdt | ROCOF, df/dt limit value | 0.10 ... 5.00 |
| Hysteresis | H | 253V (Limit) – 3V (Hysteresis) = 250V (Reset value) If the limit value is offset at F ⁻ , the hysteresis also has to be adapted so that the reset point lies at 50.05 Hz again. | 1.0 ... 180.0 0.05 ... 10.00 |
| Response time (delay Alarm) | dAL | An alarm is suppressed for the set time (seconds) | 0.05 ... 300.0 0.05 ... 180.0 |
| Turn-on time (delay Off) | daF daFR | Reset is delayed for the set time, also during voltage recovery, this time (seconds) is always counted down in the display daFR : daF for U+f together | 0 ... 6000 |
| Enable time (delay On) | dEon | There is no evaluation of the vector shift during this time; starts with the application of the control voltage and when opening the Enable input | 2 ... 20 |
| VSR | uSr | 1 Ph : a vector surge on one phase leads to an alarm 3 Ph : a vector surge on all phases simultaneously leads to an alarm | 1 Ph ... 3 Ph |
| Periods | PEr | Measuring time ROCOF, (4=sensitive, 50=insensitive) Response time= PEr * Period duration + dAL | 4 ... 50 |
| delay Display | ddi | Interval during which the display is updated in the display mode | 0.1 ... 2.0 |

12.5 Display mode (last decimal point off)

In the display mode, the UFR1001E is in its normal state; here, depending on the program, the actual voltage, the highest actual 10 minute mean value, the frequency or the vector surge is displayed. In addition, the alarm signals (e.g. **RL** , **RL n**) and error codes (e.g. **Err9**) are displayed.

| | |
|--------------------------------|--|
| Function button Set / Reset | <u>Press briefly:</u> Switches the measurement, alarm counter |
| | <u>Press for > 2 s:</u> Resets after error (not possible if doF Reset delay is counting down) |
| | <u>Press for > 4 s:</u> Displays the program, e.g. Pr 1 |
| | <u>Press for > 10 s:</u> Displays the software version, e.g. 0-05 |
| Function key Up / Down | <u>Press briefly:</u> Change into the menu mode, Display alarm counter: Down = Query the memory Up = Query the cumulative alarm time |
| | <u>Press for ≥ 2 s:</u> Displays MAX and MIN measurements, additionally pressing the Set key for ≥ 2 s deletes the saved values |

12.6 Menu mode (last decimal point on)

The menu mode is used to select the menu items. If no key is pressed for 30 s, one automatically returns to the display mode.

| | |
|--------------------------------|---|
| Function button Set / Reset | <u>Press briefly:</u> Change into the configuration mode |
| | <u>Press for ≥ 2 s:</u> Returns to the display mode (the most recently set values are then applied) |
| Function key Up / Down | <u>Press briefly:</u> Select menu item; changes into the display mode |

12.7 Configuration mode (last decimal point flashes)

In the configuration mode you can set the value of a parameter. The display alternates between the parameter relation and the currently set value until one of the Up/Down buttons is pressed, which changes the value of the parameter. If no key is pressed for 2 s the display starts alternating again.

If no key is pressed for 30 s (simulation mode 15 min) one automatically returns to the display mode (the most recently set value is applied during this)

| | |
|--------------------------------|---|
| Function button Set / Reset | <u>Press briefly:</u> The settings are taken over; continue to next parameter. Changes into menu mode after the last parameter |
| | <u>Press for ≥ 2 s:</u> Returns to the display mode (the most recently set values are then applied) |
| Function key Up / Down | <u>Press briefly/long:</u> Value change of the parameter (slow/fast) |

Hint: Simultaneously pressing the Up and Down keys resets the adjustable value to zero. If the Up or Down button is kept pressed while setting the value the change in the display is accelerated.

12.8 Test mode (timekeeping only activated and connected feedback contacts)

After pressing the Test button, the test-menu is displayed and both trip circuits can be tested. If additionally, feedback contacts of the switch are connected to the UFR100E and activated (value **ErEL** > turn-on time of switch, e.g. 5.0s), the triggering time is measured automatically. The measurement voltage has to be connected and no alarm is allowed to be present (K1 and K2 picked up)! During the test an active **Err7** is repressed. This allows troubleshooting for minimum 3 minutes.

Start test:

Select circuit K1 (**ESL1**) or K2 (**ESL2**) by pressing the buttons Up / Down. The test starts, after pressing the button Set and the selected relay is switched off. If the feedback contact is connected (Y1 or Y2), the tripping time of internal relay + switch is displayed for 3 minutes or until the button test is pressed.

Without connected / activated feedback contacts, **noY1** or **noY2** is displayed.

To exit the test-menu, wait for 3 minutes without a button or select **End** by pressing the buttons Up / Down and confirm by pressing the button Set.

12.9 Alarm counter

The alarm counter **Rc** is increased by 1 with every shut-down. Up to 100 shut-downs are counted. That allows quick detection of how often the UFR1001E has shut down since the last delete of the alarm counter (see cumulative alarm time).

Query the alarm counter:

- | |
|---|
| <ul style="list-style-type: none">• Change into the display mode |
| <ul style="list-style-type: none">• Press the ▶ button several times until → display Rcxx |

12.10 Cumulative alarm time (display in hours)

The cumulative alarm time **tRL** indicates how long the relay was switched off due to an alarm. It is recorded with a resolution of 1 minute and only when the control voltage is applied.

Query the cumulative alarm time:

- | |
|---|
| <ul style="list-style-type: none">• Change into the display mode |
| <ul style="list-style-type: none">• Press the ▶ button several times until → display Rcxx |
| <ul style="list-style-type: none">• Press the ▲ button 1x → display tRL / x.xx |

Delete the alarm counter and cumulative alarm time (only together):

- | |
|--|
| <ul style="list-style-type: none">• Display alarm counter Rcxx |
| <ul style="list-style-type: none">• Press the ▲ button 1x → display tRL / x.xx |
| <ul style="list-style-type: none">• Keep the ▶ button pressed for 2s until → display tRL / 0.00 |

12.11 Alarm memory

Independent of the alarm counter, the UFR1001E stores the most recent 100 shut-down causes (cause, measurement value, at operating time). Simulated alarms are also registered. The LEDs indicate the cause; the tripping value that led to the alarm each stands in the 7-segment display. Alternative to that the time is shown in hours which have passed since the last tripping (with applied control voltage). These values remain saved even after the power has been turned off.

Query alarm memory:

- | |
|--|
| <ul style="list-style-type: none">• Change into the display mode |
| <ul style="list-style-type: none">• Press the ▶ button several times → display Rcxx |
| <ul style="list-style-type: none">• Press the ▼ button 1x → display x.xx / x.xx (tripping value or error no. / time that has passed in hours) |
| <ul style="list-style-type: none">• Press the ▼ button 1x, go to next alarm |

The alarm memory is only deleted during a program change.

12.12 Standby counter and standby time

The standby counter **StbY**, is increased by 1 with every standby shut-down. Up to 9999 shut-downs are counted. That lets the UFR1001E quickly detect how often, e.g., shut-down was performed through a ripple control receiver.

Query the standby counter:

| |
|---|
| • Change into the display mode |
| • Press the ▶ button several times until → display RcXX |
| • Press the ▲ button 2x → display StbY / xxxx |

The standby time **StbY** indicates how long the relay was switched off by the standby mode. It is recorded with a resolution of 1 minute and only when the control voltage is applied and if no alarm is present.

Query the standby time:

| |
|--|
| • Change into the display mode |
| • Press the ▶ button several times until → display RcXX |
| • Press the ▲ button 3x → display StbY / x.xx (Time LED is illuminated) |

Delete the standby counter and standby time (only together):

| |
|--|
| • Display alarm counter RcXX |
| • Press the ▲ button 2x → display StbY / xxxx |
| • Keep the ▶ button pressed for 2s until → display StbY / 0 |

12.13 Code lock

You can protect the set parameters by enabling the code lock here.

The device acknowledges an incorrect entry with **Err** (flashes three times).

Adjustment process:

| |
|--|
| • Select the menu item with the ▲▼ buttons until → display Code . |
| • Press the ▶ button 1x → display Pin / 0 |
| • Set the saved pin code with the ▲▼ buttons (default setting is 504) |
| • Press the ▶ button 1x → display Code / oFF |
| • Use the ▲▼ buttons to set the desired code lock: <ul style="list-style-type: none">○ oFF off, all parameters can be changed○ oN on, no parameters can be changed |
| • Press the ▶ button 1x → display Pin / 504 |
| • Use the ▲▼ buttons to set the new, desired pin code (caution: write down the pin code) |
| • Press the ▶ button 1x |
| ⇒ Code lock on, display oN flashes three times |
| ⇒ Code lock off, display oFF flashes three times |
| ⇒ Return to menu mode, menu item code lock |

If there are any problems with the code lock (pin forgotten), the lock can be switched off and the pin can be reset to 504 by keeping the Set key pressed while switching on the mains until **Code** / **oFF** appears in the display.

12.14 Sealing

All the settings and the simulation mode can be locked.



If the  LED is illuminated, the UFR1001E is locked.

If an attempt is made to change a setting in the locked state, for 3s the display shows **Loc**.

Adjustment procedure Sealing/Lock ON (OFF):









| |
|---|
| <ul style="list-style-type: none">• If present, remove seal (only authorised person) |
| <ul style="list-style-type: none">• Apply control supply voltage at A1-A2 |
| <ul style="list-style-type: none">• Slightly lift the key cover and turn 180° |
| <ul style="list-style-type: none">• Actuate the small blue button by <u>pressing the button cover very firmly</u> (LED starts flashing) until the green LED  is illuminated. |



12.15 Simulation

Here, the voltage, frequency or a vector surge can be simulated and the setting can be tested. All 3 phases plus the 10 minute mean value are always simulated. All functions of the device operate as if this value is actually being measured. Alarm and error messages are only indicated with the LEDs and not in the display. The set values are simulated until the menu item **Sr** is exited with the  or  button. If the UFR1001E is sealed/locked, simulation is not possible.

If the section switch feedback contacts are connected to the UFR1001E and enabled, (set value > section-switch turn-on time under **ErEL**), after a shut-down, the tripping time (dAL + time of slowest section switch) is displayed.

Adjustment process:

| |
|---|
| <ul style="list-style-type: none">• Select the menu item with the   buttons until → display Sr |
| <ul style="list-style-type: none">• Press the  button 1x → display Sr / U |
| <ul style="list-style-type: none">• Use the   buttons to set the measurement factor for simulation:<ul style="list-style-type: none">○ U Voltage + 10min mean value (frequency = last simulated value)○ F Frequency (voltage = last simulated value)○ uSr Vector shift |
| <ul style="list-style-type: none">• Press the  button 1x → display 230 (selected measurement factor is simulated) |
| <ul style="list-style-type: none">• Use the   buttons to set the desired value |

After exiting the Simulation menu item with the   buttons, the unit switches over to monitoring the limits. The unit automatically returns to the display mode if no button is pressed for 15 minutes.

Hint: A limit value should be tested that is higher than the set 10min mean value. If the 10min mean value has to be temporarily switched off, set (**U¹⁰** → **OFF**) since otherwise it will trip first. The same applies, for example, for **U⁻**, during a simulation of **U⁻** in Pr3 and Pr4. (Medium voltage)

12.16 Possible indications in display

Display mode

| | |
|---------------|---|
| AL , AN | Alarm , Alarm 10min mean value |
| Err4 ... Err9 | Error messages (see Error messages and measures) |
| Rc , tAL | Alarm counter, cumulative alarm time |
| Scn , n | Scan mode, 10min mean value |

Menu mode / configuration mode

| | |
|---|---|
| U ⁺ , U ⁻ , U ₊ , U ₋ | Voltage limit value |
| UN | Limit value 10min mean value |
| H ⁺ , H ⁻ , H ₊ , H ₋ , HN | Hysteresis (if a limit value is changed, the reset value also shifts; that means it might be necessary to adapt it) |
| F ⁺ , F ⁻ , F ₊ , F ₋ , dFdt | Frequency limit value, ROCOF (df/dt) limit value |
| dAL | Response time |
| doF , doFA | Reset time; is always counted down in the display |
| ind , ALL | Turn-on time adjust individual / all together (e.g. for Testing) |
| uSr | Vector surge |
| Stby | Standby mode, standby-time, standby-counter |
| y1y2 | Evaluation of the feedback contacts is suppressed when E1-E2 are closed |
| dEon | Delay Enable On, suppression time when switching on and after opening the enable input |
| 1 Ph , 3 Ph | Single phase, three-phase vector shift evaluation |
| rocoF , PEr | ROCOF (df/dt), Periods |
| rEL | Relay |
| tREL | Section switch turn-on time, OFF no feedback contacts |
| ddi | Delay display, to calm down the display |
| di t | Display duration scan mode (each measurement is displayed for this duration) |
| S _i , F , U | Simulation, Frequency, voltage |
| CoDE , PLo , uSr | Code lock / sealing, vector shift |
| Pin , Info | Pin code (default 504), Device information, program change |
| Fnr , Snr | Firmware version, serial number |
| h | Operating hours |
| Err , dEL | Error counter, delete error counter |
| YES , no | Yes, no query for acknowledgement |
| Pr , on , off | Program, On, Off |
| UonF | Frequency protection off if voltage < UonF |
| tSt1 , tSt2 , noY1 , noY2 , End | Test mode: test relay K1, test relay K2, no response Y1, Y2 or monitoring feedback contacts not activated |

13 Technical Data

Control voltage Us:

Rated connection AC/DC 24-270 V, 0/40...70 Hz, < 5 VA
DC: 20.4...297 V, AC: 20.4...297 V

Output relay:

Switching voltage 2 x change-over contact
Max. AC 440 V
Conventional thermal current I_{th} 6 A
Inrush current (at 10 % ED) 25 A max. 4 s / 50 A max. 1 s
Nominal operating current I_e (AC 15) I_e = 6 A U_e = 250 V
Rated operational current DC-13 I_e = 2 A U_e = 24 V
Rated operational voltage DC-13 I_e = 0,4 A U_e = 120 V
DC-13 I_e = 0,2 A U_e = 240 V
Recommended series fuse gG/gL/B 6 A
Contact service life, mech. 30 x 10⁶ switching cycles
Contact service life, electr. 1 x 10⁶ operating cycles at AC 250 V / 6 A
2 x 10⁵ operating cycles at AC 250 V / 10 A cos φ 0.6
Clearance and creepage distance K1-K2 ≥ 3mm

Voltage measurement:

Measurement voltage phase – phase AC 15...530 V (< 5 V: 0 is displayed)
Adjustment range phase – phase AC 15...520 V
Measurement voltage phase – N AC 10...310 V (< 5 V: 0 is displayed)
Adjustment range phase – N AC 15...300 V
Measurement principle Real root mean square measurement both half waves
Hysteresis Adjustable 1.0...180.0 V
Measurement error (with N) ± 0.6 % of the measurement value
Measurement error (without N) ± 0.8 % of the measurement value
Display accuracy >100V: -1 digit (res. 1 V), <100V: -1 digit (res. 0.1V)
Measurement function 3-phase with/without N
Response time Adjustable 0.05 (±15ms)... 300.0 s
Reset time Adjustable 0 (>200ms) ... 6000 s
Input resistance Phase-N 227 kΩ

Frequency measurement

Frequency range 40...70 Hz
Adjustment range 45.00...65.00 Hz
Hysteresis 0.05...10.00 Hz
Measurement accuracy ± 0.04Hz ± 1 digit
Response time Adjustable 0.05 (±15ms)...300.0 s
Reset time Adjustable 0 (>200ms) ... 6000 s
Frequency undervoltage protection off / 10,0...320 V

Vector surge

Measurement range 0...90.0°
Adjustment range 2.0...65.0°
Response time < 50 ms
Reset time Adjustable 3...240 s
Delay at U_s on Adjustable 2...20 s

ROCOF (df/dt)

Frequency range 40...70 Hz
Adjustment range 0,100...5,000 Hz/s, 4...50 Periods
Hysteresis fixed 0,05Hz
Measurement error ± 0,04Hz ± 1Digit
Response time adjustable 0,05 (±15ms) ... 130,0 s
Reset time adjustable 0 (>200ms) ... 999 s
Measurement time Number of adjusted Periods * Periods duration + Response time

Digital outputs (galvanic isolated)

| | |
|----------------------|--------------------|
| Switching voltage I1 | DC 4.5...27 V |
| Current Q1...Q5 | Max 20 mA / output |

Contactor feedback inputs

| | |
|--|-------------------------|
| Voltage / Current Y0 – Y1/2 | DC 15...35 V / ca. 4mA |
| Voltage / Current E1 – E2 | DC 15...35 V / ca. 6mA |
| Contactor response time (section switch) | Adjustable 0.5...99.0 s |

Test conditions

| | | |
|--|--|---|
| | IEC/EN 60255 | |
| Rated impulse voltage | 4000 V | |
| Overvoltage category | III | |
| Pollution degree | 2 | |
| Rated insulation voltage Ui | 300 V | |
| Operating time | 100 % | |
| Operating temperature | -20 °C... +55 °C | |
| Storage temperature | -25 °C ... +70 °C | |
| Climatic conditions (IEC/EN 60721-3-3) | 3K5 (except condensation and formation of ice) | |
| Tests IEC/EN 60255-1 | | |
| Storage tests | | |
| Dry heat | IEC 60068-2-2 | + 70 °C 16 h |
| Cold | IEC 60068-2-1 | - 25 °C 16 h |
| Operational tests | | |
| Dry heat | IEC 60068-2-2 | + 55 °C 16 h |
| Cold | IEC 60068-2-1 | - 20 °C 16 h |
| Cyclic temperature | IEC 60068-2-14 | - 25 °C / + 55 °C 5 cycle 3 + 3 h |
| Damp heat steady state | IEC 60068-2-78 | + 40 °C 95 % RH 21 days |
| Cyclic temperature with humidity | IEC 60068-2-30 | + 25 °C 97% RH / + 55 °C 93 % RH 6 cycle 12 + 12 h |
| IEC 60255-21-1 | vibration | class 1 |
| IEC 60255-21-2 | shock | class 1 |
| IEC 60255-21-3 | seismic test | class 1 |
| EMC - immunity | EN 61000-6-2 | |
| EMC - emission | EN 61000-6-3 | |

Housing:

| | |
|---------------------------------------|---|
| Construction form | V6 |
| Front-to-back size | 55 mm |
| Dimensions (W x H x D) | 90 x 105 x 69 mm |
| Wiring connection single strand | each 1 x 4mm ² |
| Finely stranded with wire end ferrule | each 1 x 2.5mm ² |
| Protection class, housing | IP 30 |
| Protection class, terminals | IP 20 |
| Weight: | Mounting snap-on fastening on 35 mm mounting rail acc EN 60 715 or with M4 screwed attachment (additional bar not included in the scope of delivery) approx. 250 g |

We reserve the right to make technical changes

14 Maintenance and repair

The UFR1001E is maintenance-free. Periodically test for proper functioning.

15 Troubleshooting and measures

| Error | Cause | Remedy |
|---|--|---|
| EEEE or -EEE appears in the display | Measurement is above/below range | Measured voltage, frequency or the vector surge is too large or too small; comply with measurement range |
| Err4 appears in the display | Tolerance error, internal measurement value deviation of both channels | Perform a reset → interrupt control voltage for >5s * |
| Err5 appears in the display | Error internal interface | |
| Err6 appears in the display | Communication error, internal interface | |
| Err7 appears in the display even after 2 automatic repeated trials of switching on + LED K1 and/or K2 is lightning | Error feedback contacts, switches not connected correctly or broken or switches are controlled from other device | <u>Feedback contacts not connected</u> - set rEL. → tREL. → oFF <u>Feedback contacts connected</u> - check the correct connection - Adjust the turn-on time under rEL. → tREL. greater then the switch-on time of the switcher - Perform a reset → press Set/Reset for >2 s |
| Err8 appears in the display | Hysteresis error | Upper threshold value must be higher than the lower threshold value, check the threshold values |
| Err9 appears in the display | Parameter error | Reset to factory settings, see "Program setup" * |
| A time expires in the display | Always when an OFF-delay time doF is running, it is counted down in the display (shortest one first) | Wait until the time has expired (depending on the setting, several times may elapse one after the other) |
| Device cannot be configured / only the limits can be configured | Code lock / Sealing activated | If there are any problems with the code lock (pin forgotten), the lock can be switched off and the pin can be reset to 504 by keeping the Set key pressed while switching on the mains until CoDE / oFF appears in the display. |
| Implausible voltage values | Pr selected with N, but N not connected | Select Pr without N or connect N |
| Loc appears in the display | Seal is active | See Sealing |
| CoDE appears in the display | Code lock is active | See „Code lock“ |
| StbY appears in the display | Standby mode, E1-E2 closed | Check parameter u5r. |
| AL and LED Q3 (f>) is on, reading in good range | hysteresis for F⁻ incorrectly | Check hysteresis for reset point 50,05 Hz |
| noY1 or noY2 appears in the display | Feedback contact not connected or switch does not switch | Check the connection and function of the switch. Its normal in Pr2 at Test 2 noY2 . |

* If the error cannot be patched by a reset, send back to factory for repair.

16 Construction form V6

Dimensions in mm

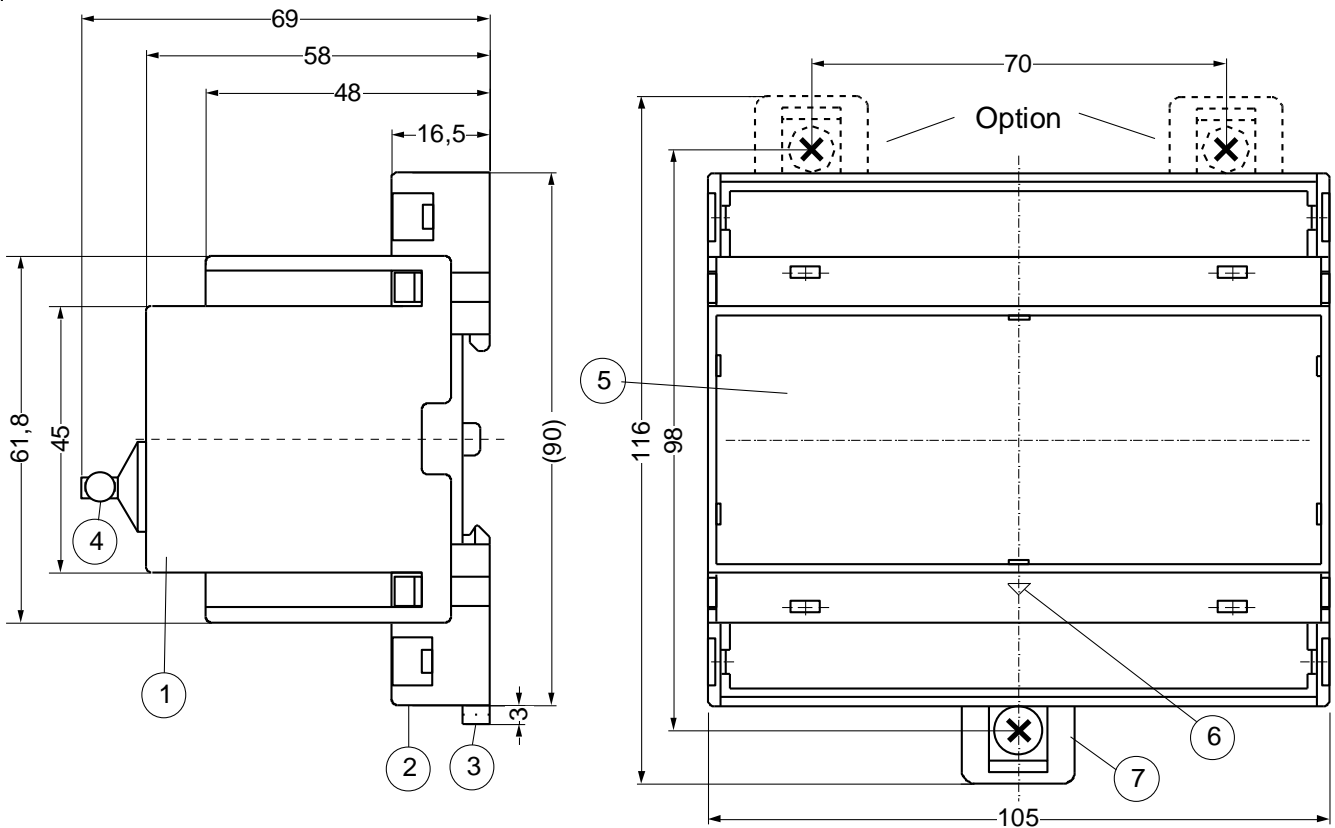

- 1 Oberteil / cover
- 2 Unterteil / base
- 3 Riegel / bar for snap mounting
- 4 Sealing max. \varnothing 1.8 mm
- 5 Frontplatteneinsatz / front panel
- 6 Kennzeichen für unten / position downward
- 7 Bar for wall attachment with screws. Riegelbohrung \varnothing 4,2 mm / Bolt hole for fixing to wall with screws, \varnothing 4.2 mm.

17 Disposal

Disposal should be carried out properly and in an environmentally friendly manner in accordance with legal provisions.

18 Adjustment values table VDE-AR-N 4105:2011, Low Voltage Pr 1+7

| Protective function | AR 4105 | ZIEHL | in * Un | in % Un | Adjustment value | Tripping time dAL | OFF-delay time doF |
|---|---------|----------------|-----------|---------|------------------|-------------------|--------------------|
| Voltage decrease protection | U< | U ₋ | 0.8 * Un | 80 % Un | 184 V | 100 ms | 60 s |
| Voltage increase protection (10-minutes mean value) | U> | U _∏ | 1.1 * Un | 110% Un | 253V | 100 ms | 60 s |
| Voltage increase protection | U>> | U ⁻ | 1.15 * Un | 115% Un | 264V | 100 ms | 60 s |
| Frequency decrease protection | f< | F ₋ | | | 47.5Hz | 100 ms | 60 s |
| Frequency increase protection | f> | F ⁻ | | | 51.5Hz | 100 ms | 60 s |

19 Adjustment values table BDEW June 2008, acc 3.2.3.3-1, Medium Voltage Pr 3-6

| Function | | | Adjustment range of the protective relay | Default settings | |
|-------------------------------|------|----------------|--|---------------------|--------|
| | BDEW | ZIEHL | | | |
| Voltage increase protection | U>> | U ⁻ | 1.00 – 1.30 U _n | 1.15 U _n | 100 ms |
| Voltage increase protection | U> | U ⁻ | 1.00 – 1.30 U _n | 1.08 U _n | 60 s |
| Voltage decrease protection | U< | U ₋ | 0.10 – 1.00 U _n | 0.80 U _n | 2.7 s |
| Voltage decrease protection * | U<< | U ₋ | 0.10 – 1.00 U _n | 0.45 U _n | 300 ms |
| Frequency increase protection | f> | F ⁻ | 50.0 – 65.0 Hz | 51.5Hz | 100 ms |
| Frequency decrease protection | f< | F ₋ | 45.0 – 50.0 Hz | 47.5Hz | 100 ms |

* Not enabled in as delivered condition

20 Adjustment values table VDE-AR-N 4105:2018-11, Low Voltage 6. table 2, Pr 2

Adjustment values for converters

| Protective function | AR 4105 | ZIEHL | in * Un | in % Un | Adjustment value | Tripping time dAL | OFF-delay time doF |
|---|---------|----------------|-----------|----------|------------------|-------------------|--------------------|
| Voltage increase protection | U>> | U ⁻ | 1,25 * Un | 125 % Un | 287 V | 100 ms | 60 s |
| Voltage increase protection (10-minutes mean value) | U> | U _∏ | 1,1 * Un | 110 % Un | 253 V | 100 ms | 60 s |
| Voltage decrease protection | U< | U ₋ | 0,8 * Un | 80 % Un | 184 V | 3,0 s | 60 s |
| Voltage decrease protection | U<< | U ₋ | 0,45 * Un | 45 % Un | 103 V | 300 ms | 60 s |
| Frequenzsteigerungsschutz | f> | F ⁻ | | | 51,5 Hz | 100 ms | 60 s |
| Frequenzrückgangsschutz | f< | F ₋ | | | 47,5 Hz | 100 ms | 60 s |

21 Adjustment values VDE-AR-N 4110:2018-11, Medium Voltage higher protection Pr 11+12

Acc. to 10.3.5.3 table 12, higher protection device

| Funktion | AR 4110 | ZIEHL | Einstellbereich des Schutzrelais | Werkseinstellungen | |
|---|---------|----------|----------------------------------|--------------------|--------|
| | | | | | |
| Voltage increase protection | $U \gg$ | U^{--} | 1,00 – 1,30 U_n | 1,2 U_n | 300 ms |
| Voltage increase protection | $U >$ | U^- | 1,00 – 1,30 U_n | 1,1 U_n | 180 s |
| Voltage decrease protection | $U <$ | U_- | 0,10 – 1,00 U_n | 0,80 U_n | 2,7 s |
| Frequency increase protection * | $f >$ | F^- | 50,0 – 65,0 Hz | 51,5 Hz | 5,4 s |
| Frequency decrease protection * | $f <$ | F_- | 45,0 – 50,0 Hz | 47,5 Hz | 400 ms |
| * Not enabled in as delivered condition | | | | | |

22 Adjustment values VDE-AR-N 4110:2018-11, Medium Voltage Unit Protection Pr 13+14

Acc. to 10.3.5.3 table 13, protection at the generating units

| Funktion | AR 4110 | ZIEHL | Adjustment range of the protective relay | Default settings | |
|-------------------------------|---------|----------|--|------------------|--------|
| | | | | | |
| Voltage increase protection | $U \gg$ | U^{--} | 1,00 – 1,30 U_n | 1,25 U_n | 100 ms |
| Voltage decrease protection | $U <$ | U_- | 0,10 – 1,00 U_n | 0,80 U_n | 1,0 s |
| Voltage decrease protection | $U \ll$ | U_{--} | 0,10 – 1,00 U_n | 0,45 U_n | 300 ms |
| Frequency increase protection | $f \gg$ | F^{--} | 50,0 – 65,0 Hz | 52,5 Hz | 100 ms |
| Frequency increase protection | $f >$ | F^- | 50,0 – 65,0 Hz | 51,5 Hz | 5,0 s |
| Frequency decrease protection | $f <$ | F_- | 45,0 – 50,0 Hz | 47,5 Hz | 100 ms |